

DICSA

#HydraulicsExperts

STAINLESS STEEL FITTINGS

Racores Inoxidables · *Edelstahl* · Raccords en Acier Inox

AISI 316L

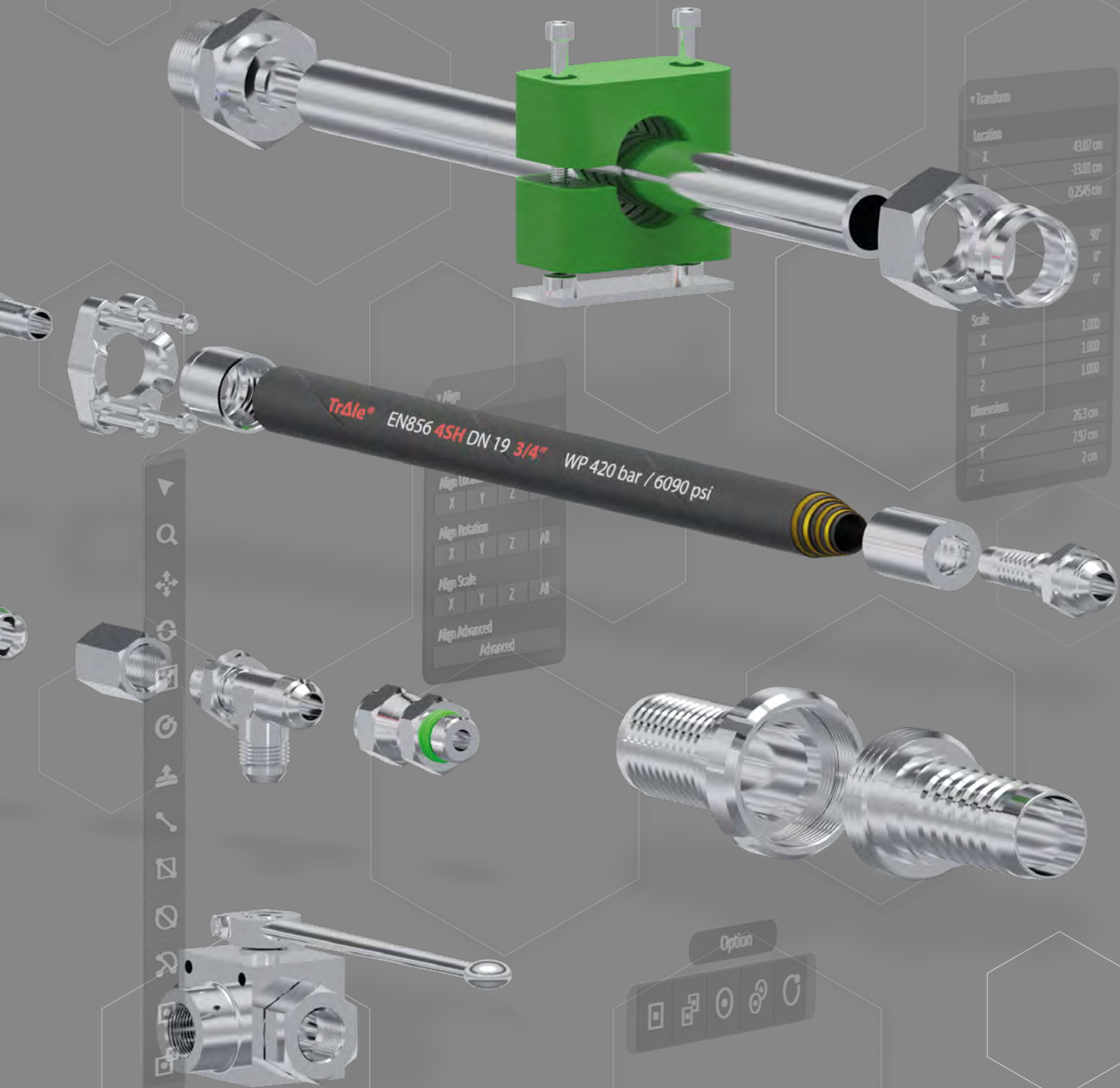

TrAle®

www.dicsaes.com

2024

MUCHO MÁS QUE UNA PÁGINA WEB
MORE THAN JUST A WEBSITE

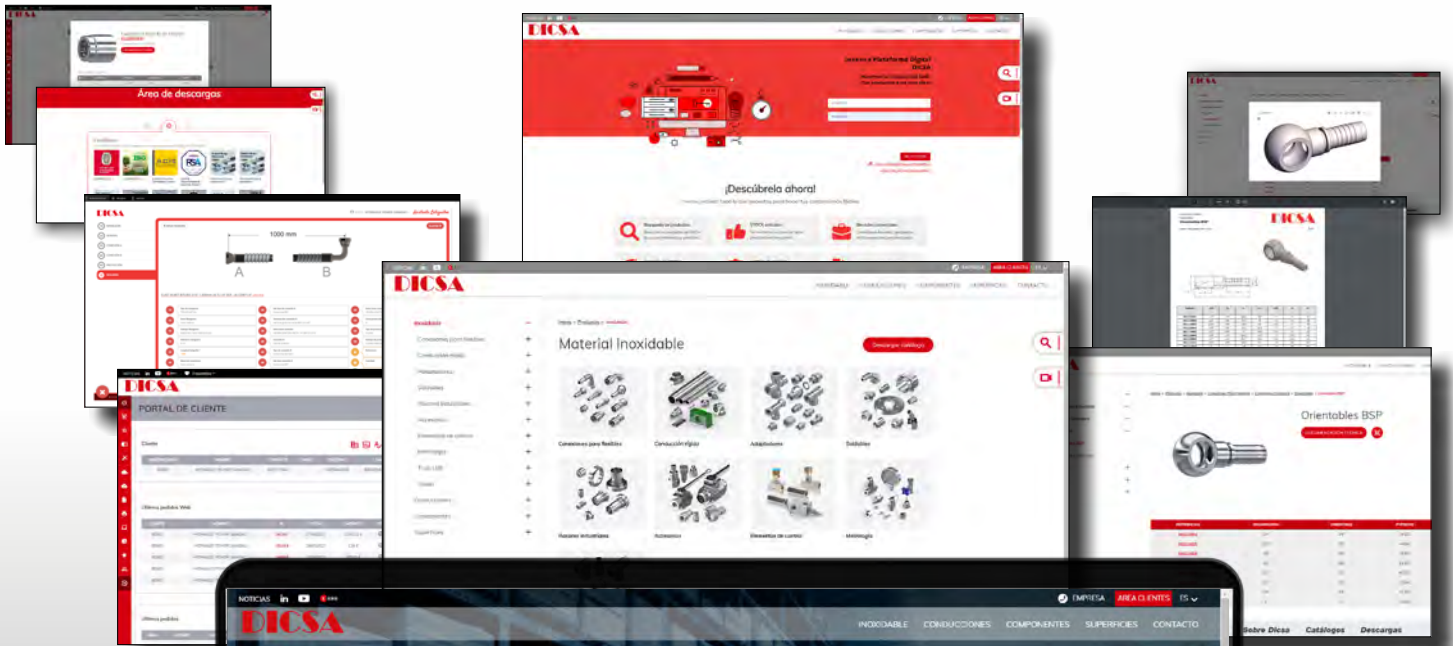

Servicio
Factura
B2B
Rápido
Funcional

Services
B2B
Fast
Funtional

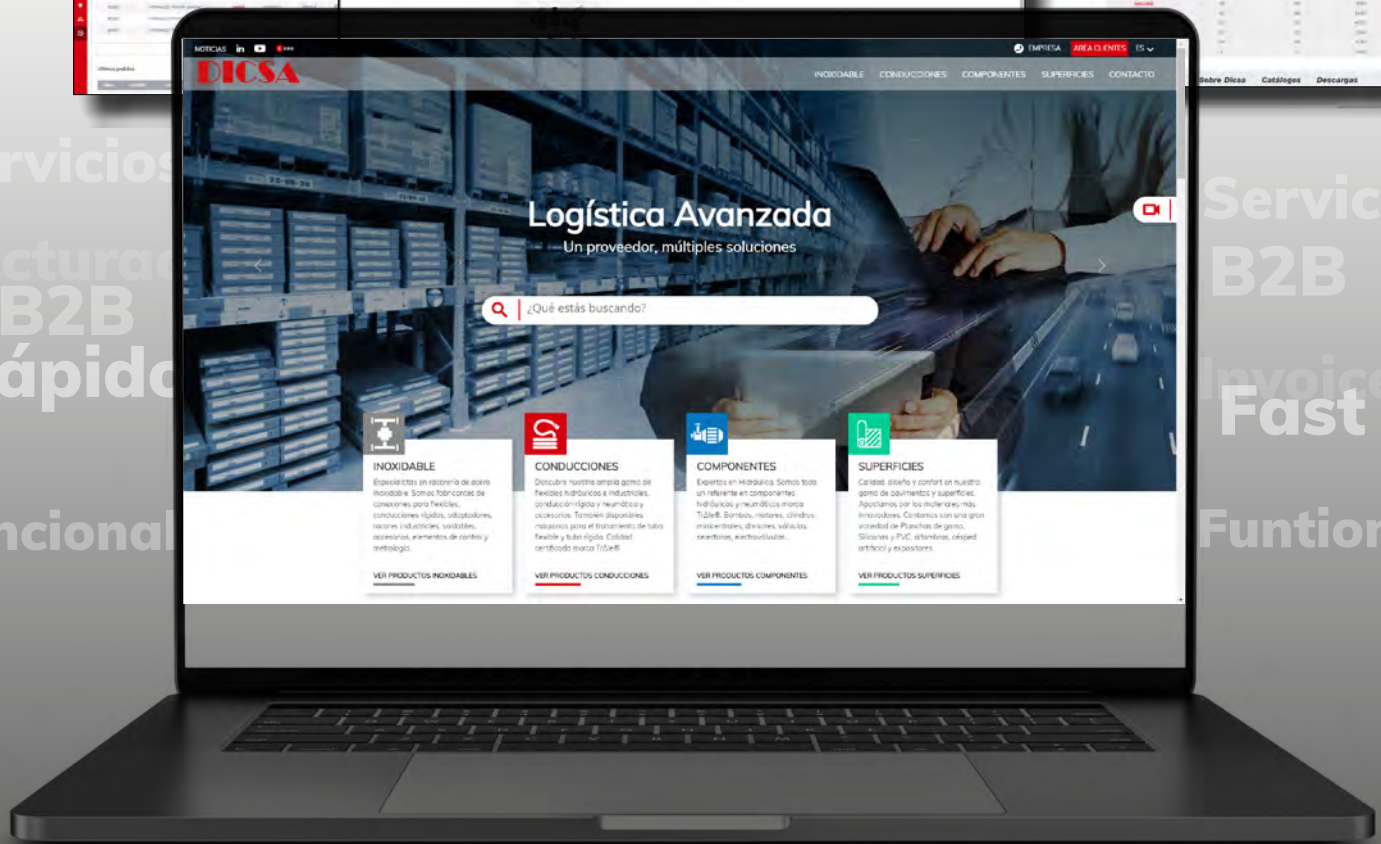

CRIMP FITTINGS FOR HOSES

Conexiones para flexibles
Armaturen für Schlauchleitungen
Embouts à sertir pour flexibles



TRALE® RIGID PIPE/ PIPE FITTINGS DIN 2353/ FLARE FITTINGS JIC 37°

Tubo rígido TRALE® / Racores DIN 2353 / Racores JIC 37°
RohrTRALE® / Verschraubungen für Rohr DIN 2353/ JIC - Verbindungen
Tube rigide TRALE®/ Raccords DIN 2353/ Adapteurs JIC 37°



SCH TRALE® RIGID PIPE/ SCH FITTINGS / SAE FLANGES / CLAMPS

Tubo rígido TRALE® SCH / Racores SCH / Bridas SAE / Abrazaderas
Rohr SCHTRALE®/ SCH Armaturen/ SAE-Flansche/ Schellen
Tube rigide TRALE® SCH / Embouts SCH / Brides SAE/ Colliers



ADAPTORS

Adaptadores
Adapter
Adapteurs



WELDING FITTINGS

Racores soldables
Schweißverschraubungen
Raccords à souder



INDUSTRIAL FITTINGS

Racores industriales
Für den industriellen Einsatz
Raccords industriels



ACCESSORIES

Accesorios
Zubehör
Accessoires



HYDRAULIC COMPONENTS AISI 316

Componentes hidráulicos AISI 316
Hydraulische Komponenten
Composants Hydrauliques AISI 316



FLOW MEASURING

Metrología
Messtechnik
Test du circuit hydraulique



TWIN FERRULE FITTINGS TRALE® LOK

Racor doble anillo TRALE® Lok
Verschraubungen für Doppelklemmring TRALE® Lok
Raccord double bague TRALE® Lok



Standard series 22

Conexiones Standard
Standardserie
Embouts série standard

Fittings BW+ Series R13/R15 No Skive 42

Conexiones Serie BW+ R13/R15 No Pelar
Armaturen Serie BW+ R13/R15 ohne Schälung
Embouts R13/R15 Série BW+ Sans denuder

Interlock series 46

Conexiones Interlock
Armaturen Interlock
Embouts Interlock

Ferrules for one piece fittings 51

Casquillos para conexiones una sola pieza
Pressfassungen für einteilige Armaturen
Jupes pour embouts pré-sertis

One piece fittings 43 Series R1AT/R2AT/1SN/2SN/R16/2SC/R17 52

Conexiones una sola pieza Serie 43
R1AT/R2AT/1SN/2SN/R16/2SC/R17
Einteilige Armaturen Serie 43
R1AT/R2AT/1SN/2SN/R16/2SC/R17
Embouts pré-sertis
R1AT/R2AT/1SN/2SN/R16/2SC/R17 Série 43

One piece fittings BWS Series 3SP/4SP/R12/4SH No Skive 60

Conexiones una sola pieza Serie BWS
3SP/4SP/R12/4SH No Pelar
Einteilige Armaturen Serie BWS
3SP/4SP/R12/4SH ohne Schälung
Embouts pré-sertis Série BWS
3SP/4SP/R12/4SH Sans dénuder

One piece fittings BW+ Series R13/R15 No Skive 67

Conexiones una pieza Serie BW+ R13/R15 No Pelar
Armaturen Serie BW+ R13/R15 ohne Schälung
Embouts R13/R15 Série BW+ Sans denuder

One piece fittings R7/R8 & Elastomer Braid of steel wire 70

Conexiones una sola pieza R7/ R8/ Elastómero malla metálica
Einteilige Armaturen R7/ R8 und Elastomer/Metallumfl.
Embouts pré-sertis R7/R8 et Elastomère tresse métallique

One piece fittings for Smooth PTFE/ R14 75

Conexiones una sola pieza PTFE Liso / R14
Einteilige Armaturen PTFE-Glattschlauch/ R14
Embouts pré-sertis pour PTFE lisse/ R14

One piece fittings for convoluted PTFE 80

Conexiones una sola pieza PTFE Corrugado
Einteilige Armaturen PTFE-Wellschlauch
Embouts pré-sertis pour PTFE convoluté

Reusable series 85

Conexiones Reusables
Schraubarmaturen
Embouts série récupérable

Push-On Fittings 88

Conexiones Push-On
Aufsteck-Armaturen
Embouts Push-On

High pressure 700 bar fittings 89

Conexiones Alta Presión (700 bar)
Armaturen Hochdruck (700bar)
Embouts haute pression 700 bar



01

CRIMPING FITTINGS FOR HOSES

Conexiones para Flexibles

Pressfassungen für Schlauchleitungen

Embouts à sertir pour flexibles

STANDARD SERIES

Serie Standard

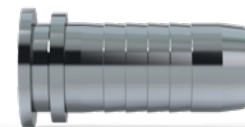

TrAle®

TrAle® GOLD

GREENLINE

SAE 100 R6	EN 854 2TE	EN 854 3TE	SAE 100 R17	EN 857 2SC SUPERSERVICE 2SC 155°	EN 853 1SN SAE 100 R1AT 1SNK	EN 853 2SN SAE 100 R2AT 2SNK	EXCEED EN 857 2SCK	EN 857 2SC SUPERSERVICE 2SC 155°
81014		ZPF22120...	ZSC2112...	ZSC2112/ZPF22120		ZPF22120...		

EN 853 2ST SAE100 R2A	EN 856 4SP SAE 100 R9R	EN 856 R12 SAE 100	3SP	EN 856 4SP SAE 100 R9R	EN 856 4SH	EN856 R12 SAE 100	EN 856 R13 SAE 100	SAE 100 R15
ZPF12240...			NO PELAR NO SKIVE		ZPF2224...		3/4"-1"	

SAE 100 R7 EN 855	SAE 100 R8 EN 855	Metallic 1 braid	Metallic 2 braid	Ecology 200	Ecology 250
81014...		81014...	ZPF1224	Z2120...	

Smooth PTFE R14 1 braid	Convuluted PTFE Standard	PTFLEX	Smooth PTFE R14 1 braid	Smooth PTFE 2 braid	Standard Convuluted PTFE	Fiberglass Convuluted PTFE	Antistatic Convuluted PTFE
88040...	88041...	81041...	81040...	81045...	81041...		

BW+ SERIE NO SKIVE

BW+ Series no pelar



EN 856
R13
SAE 100

SAE 100
R15

ZAC69010...

1" 1/4-1" 1/2-2"

INTERLOCK SERIES

Serie Interlock



856 4SH WP 420 bar / 6090 psi

856 R13 / SAE 100 R13

SAE 100 R15

EN 856
4SH

EN 856
R13
SAE 100

SAE 100
R15

ZA61010...

ZA61010...
Z61010...

ONE PIECE SERIES

Serie Compacta
Einteilige Armaturen
Série Pré-sertis

- One piece fittings 1SC / 1SN / 2SC / R6 / 2TE
Conexiones compactas 1SC / 1SN / 2SC / R6 / 2TE
Einteilige Armaturen 1SC / 1SN / 2SC / R6 / 2TE
Embouts pré-sertis 1SC / 1SN / 2SC / R6 / 2TE



EN 857 1SC	EN 853 1 SN SAE 100 R1AT	EN 857 2SC	EN 854 SAE 100 R6	EN 854 2TE
---------------	-----------------------------------	---------------	-------------------------	---------------

- One piece fittings 43 Series R1AT / R2AT / 1SN / 2SN / R16 / 2SC / 3TE / R17
Conexiones compactas Serie 43 R1AT / R2AT / 1SN / 2SN / R16 / 2SC / 3TE / R17
Einteilige Armaturen Serie 43 R1AT / R2AT / 1SN / 2SN / R16 / 2SC / 3TE / R17
Embouts pré-sertis R1AT / R2AT / 1SN / 2SN / R16 / 2SC / 3TE Série 43/R17



EN 853 1SN SAE 100R1AT	EN 853 2 SN SAE 100 R2AT	EN 857 2SC SAE 100 R16	SUPERSERVICE 155° 2SC	3TE
------------------------------	-----------------------------------	---------------------------------	-----------------------------	-----

- One piece fittings Standar BWS Series NON SKIVE 3SP / 4SP / 4SH / R12
Conexiones compactas Serie BWS NO PELAR 3SP / 4SP / 4SH / R12
Einteilige Armaturen Serie BWS OHNE SCHÄLUNG 3SP / 4SP / 4SH / R12
Embouts pré-sertis BWS SANS DÉNUDÉ 3SP / 4SP / 4SH / R12



NO PELAR
NO SKIVE

3SP	EN 856 4SP SAE 100 R9R	EN 856 4SH	EN856 R12 SAE 100	EN 856 R13 SAE 100	SAE 100 R15
3/4"-1"					

- One piece fittings BW+ Series NON SKIVE R13 / R15
Conexiones compactas Serie BW+ NO PELAR R13 / R15
Einteilige Armaturen Serie BW+ OHNE SCHÄLUNG R13 / R15
Embouts pré-sertis BW+ SANS DÉNUDÉ R13 / R15



NO PELAR
NO SKIVE

EN 856 SAE 100 R13	SAE 100 R15
--------------------------	----------------

- Piece fittings R7 / R8 & braid of steel wire
Conexiones compactas R7 / R8 y elastómero malla metálica
Einteilige Armaturen R7/ R8 und Elastomer/Metallumfl.
Embouts pré-sertis R7 / R8 et tresse métallique



SAE 100 R7	SAE 100 R8	Metallic braid elastomer
---------------	---------------	--------------------------------

- One piece fittings for smooth PTFE R14
Conexiones compactas PTFE liso R14
Einteilige Armaturen PTFE-Glattschlauch R14
Embouts pré-sertis pour PTFE lisse R14



Smooth PTFE 1 braid

- One piece fittings for convoluted PTFE
Conexiones compactas PTFE corrugado
Einteilige Armaturen PTFE-Wellenschlauch
Embouts pré-sertis pour PTFE convolute



Convoluted
PTFE

Standard series

Conexiones Standard
Standardserie
Embouts série standard

Crimping ferrules ▪ Casquillos para prensar ▪ Pressfassungen ▪ Jupes à sertir | 22



BSP Fittings ▪ Conexiones BSP ▪ Armaturen BSP ▪ Embouts BSP | 25



NPT-NPSM Fittings ▪ Conexiones NPT-NPSM ▪ Armaturen NPT-NPSM ▪ Embouts NPT-NPSM | 29



JIC 37° Fittings ▪ Conexiones JIC 37° ▪ Armaturen DKJ ▪ Embouts JIC 37° | 30



Metric fittings ▪ Conexiones Métricas DIN 2353 ▪ Armaturen DKO ▪ Embouts Métriques | 32



Standpipes ▪ Espigas lisas ▪ Stutzen glatt ▪ Embouts lisses | 36



Other Fittings ▪ Conexiones Varias ▪ Verschiedene Armaturen ▪ Autres | 37



Hydrowashing machine couplings ▪ Terminales hidrolavadoras ▪ Armaturen für Waschgeräte ▪ Embouts pour hydro-nettoyage | 37



Standard series

Conexiones Standard
Standardserie
Embouts série standard

PIPE
FITTINGS

Banjos ▪ Orientables ▪ Ringaugen ▪ Embouts Banjo

| 38



PIPE
FITTINGS II

SAE Flanges/Code 61 & 62 ▪ Bidas SAE ▪ SAE-Flansche ▪ Brides SAE

| 39

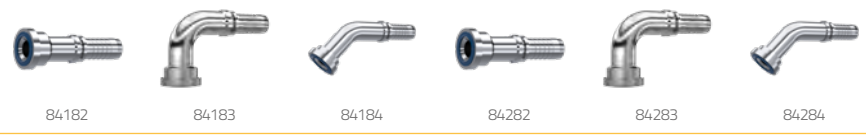

ADAPTORS

SAE Flanges for hoses ▪ Bidas para flexibles ▪ Flansche für Schlauch ▪ Brides SAE pour flexibles

| 40



WELDING
FITTINGS

ORFS Fittings ▪ Conexiones ORFS ▪ ORFS-Armaturen ▪ Embouts ORFS

| 41

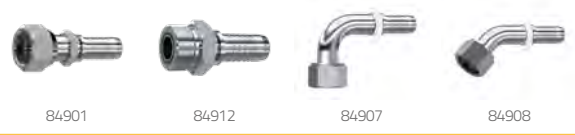

INDUSTRIAL
FITTINGS

O´Ring Boss Fittings ▪ Conexiones O´Ring Boss ▪ O´Ring Boss-Armaturen ▪ Embouts O´Ring Boss

| 41



ACCESSORIES

CONTROL
COMPONENTS

FLOW
MEASURING

TRALE LOK

Fittings BW+ Series R13/R15 No Skive

Conexiones Serie BW+ R13/R15 No Pelar
 Armaturen Serie BW+ R13/R15 ohne Schälung
 Embouts R13/R15 Série BW+ Sans denuder

Ferrules for fittings BW/ BW+ series ▪ Casquillos para conexiones serie BW/ BW+ ▪ Pressfassungen für Armaturen Serie BW/ BW+ ▪ Jupes pour embouts série BW/ BW+

42



ZAC69010

BSP fittings ▪ Conexiones BSP ▪ Armaturen BSP ▪ Embouts BSP

42



Z66410



Z66117



Z66118



Z66112



Z66510



Z66517



Z66518

NPT/NPSM fittings ▪ Conexiones NPT/NPSM ▪ Armaturen NPT/NPSM ▪ Embouts NPT/NPSM

43



Z66461



Z66161

JIC 37° fittings ▪ Conexiones JIC 37° ▪ Armaturen JIC 37° ▪ Embouts JIC

43



Z66242



Z66138



Z66139



Z66141

ORFS fittings ▪ Conexiones ORFS ▪ Armaturen ORFS ▪ Embouts ORFS

44



Z66901



Z66907



Z66908



Z66912

Metric fittings ▪ Conexiones Métricas DIN 2353 ▪ Armaturen metr. DIN 2353 ▪ Embouts Métriques

44



Z66204



Z66205



Z66206



Z66203

SAE Flanges/ Code 61 & 62 ▪ Bidas SAE ▪ SAE-Flansche ▪ Brides SAE

45



Z66282



Z66283



Z66284

CRIMPING FITTINGS
FOR HOSES

PIPE
FITTINGS

PIPE
FITTINGS II

ADAPTORS

WELDING
FITTINGS

INDUSTRIAL
FITTINGS

ACCESSORIES

CONTROL
COMPONENTS

FLOW
MEASURING

TRALE LOK

Interlock series

Conexiones Interlock

Armaturen Interlock

Embouts Interlock

PIPE FITTINGS

Interlock Crimping ferrules ▪ Casquillos Interlock ▪ Pressfassungen Interlock ▪ Jupes à sertir Interlock

| 46



Z61010

Z61010

PIPE FITTINGS II

Interlock BSP & NPT fittings ▪ Conexiones BSP y NPT ▪ Armaturen Interlock BSP, NPT ▪ Embouts à sertir Interlock BSP et NPT

| 46



Z64107

Z64108

Z64112

Z64161

Z64500

Z64507

Z64508

ADAPTORS

Interlock JIC 37° fittings ▪ Conexiones JIC 37° ▪ Armaturen Interlock JIC 37° ▪ Embouts à sertir Interlock JIC

| 48



Z64242

Z64142

Z64140

Z64138

Z64139

WELDING FITTINGS

Interlock Metric fittings ▪ Conexiones Métricas DIN 2353 ▪ Armaturen Interlock metr. ▪ Embouts Métrique Interlock

| 49



Z64204

Z64205

Z64206

Z64203

INDUSTRIAL FITTINGS

Interlock ORFS fittings ▪ Conexiones ORFS ▪ Armaturen Interlock ORFS ▪ Embouts à sertir Interlock ORFS

| 49



Z64901

Z64912

Z64907

Z64908

ACCESSORIES

Interlock SAE Flanges/ Code 61 & 62 ▪ Bridas SAE ▪ SAE-Flansche ▪ Brides SAE Interlock

| 50



Z64182

Z64183

Z64184

Z64282

Z64283

Z64284

CONTROL COMPONENTS

FLOW MEASURING

TRALE LOK

Ferrules for one piece fittings

Casquillos para conexiones una sola pieza

Pressfassungen für einteilige Armaturen

Jupes pour embouts pré-sertis

Ferrules for one piece fittings ▪ Casquillos para Conexiones una sola pieza ▪ Pressfassungen für einteilige Armaturen
▪ Jupes pour embouts pré-sertis

51



ZPFC2212



ZPF2224



88012



88040



88041



ZSCC2112



ZAC69010

One piece fittings 43 Series R1AT/R2AT/1SN/2SN/R16/2SC/R17

Conexiones una sola pieza Serie 43 R1AT/R2AT/1SN/2SN/R16/2SC/R17

Einteilige Armaturen Serie 43 R1AT/R2AT/1SN/2SN/R16/2SC/R17

Embouts pré-sertis R1AT/R2AT/1SN/2SN/R16/2SC/R17 Série 43

One piece JIC 37° fittings ▪ Conexiones una sola pieza JIC 37° ▪ Einteilige Armaturen JIC 37° ▪ Embouts pré-sertis JIC 37° | 52



88242 88142 88140 88138 88139

One piece ORFS fittings ▪ Conexiones una sola pieza ORFS ▪ Einteilige Armaturen ORFS ▪ Embouts pré-sertis ORFS | 54



88900 88907 88912 88908

One piece NPT-NPSM fittings ▪ Conexiones una sola pieza NPT-NPSM ▪ Einteilige Armaturen NPT-NPSM ▪ Embouts pré-sertis NPT-NPSM | 55



88361 88261 88262 88263 88161 88165

One piece SAE Flanges fittings ▪ Conexiones una sola pieza Bridas SAE ▪ Einteilige Armaturen SAE-Flansche ▪ Embouts pré-sertis Brides SAE | 56



88182 88183 88184 88282 88283 88284

One piece Metric fittings ▪ Conexiones una sola pieza Métricas ▪ Einteilige Armaturen metr. ▪ Embouts pré-sertis Métriques | 57



88804 88203 88305 88306

One piece BSP fittings ▪ Conexiones una sola pieza BSP ▪ Einteilige Armaturen BSP ▪ Embouts pré-sertis BSP | 59



88400 88100 88200 88107 88108 88112

One piece fittings BWS Series 3SP/4SP/R12/4SH No Skive

Conexiones una sola pieza Serie BWS 3SP/4SP/R12/4SH No Pelar
Einteilige Armaturen Serie BWS 3SP/4SP/R12/4SH ohne Schälung
Embouts pré-sertis Série BWS 3SP/4SP/R12/4SH Sans dénuder

One piece JIC 37° fittings ▪ Conexiones una sola pieza JIC 37° ▪ Einteilige Armaturen JIC 37° ▪ Embouts pré-sertis JIC 37° | 60



Z58242

Z58138

Z58140

Z58142

Z58139

One piece ORFS fittings ▪ Conexiones una sola pieza ORFS ▪ Einteilige Armaturen ORFS ▪ Embouts pré-sertis ORFS | 61



Z58901

Z58907

Z58912

Z58908

One piece NPT-NPSM fittings ▪ Conexiones una sola pieza NPT-NPSM ▪ Einteilige Armaturen NPT-NPSM ▪ Embouts pré-sertis NPT-NPSM | 62



Z58361

Z58262

Z58161

Z58261

Z58263

Z58165

One piece SAE Flanges fittings/ Code 61 & 62 ▪ Conexiones una sola pieza Bridas SAE ▪ Einteilige Armaturen SAE-Flansche ▪ Embouts pré-sertis Brides SAE | 63



Z58182

Z58183

Z58184

Z58282

Z58283

Z58284

One piece Metric fittings ▪ Conexiones una sola pieza Métricas ▪ Einteilige Armaturen metr. ▪ Embouts pré-sertis Métriques | 64



Z58804

Z58305

Z58203

Z58306

One piece BSP fittings ▪ Conexiones una sola pieza BSP ▪ Einteilige Armaturen BSP ▪ Embouts pré-sertis BSP | 65



Z58400

Z58117

Z58112

Z58200

Z58118

Z58110

One piece fittings BW+ Series R13/R15 No Skive

Conexiones una pieza Serie BW+ R13/R15 No Pelar
Armaturen Serie BW+ R13/R15 ohne Schälung
Embouts R13/R15 Série BW+ Sans denuder

PIPE
FITTINGS

JIC 37° fittings ▪ Conexiones JIC 37° ▪ Armaturen JIC 37° ▪ Embouts JIC 37°

| 67



Z69242

Z69138

Z69141

Z69139

PIPE
FITTINGS II

ORFS fittings ▪ Conexiones ORFS ▪ Armaturen ORFS ▪ Embouts ORFS

| 67

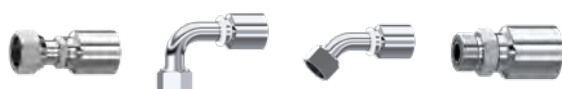

Z69901

Z69907

Z69908

Z69912

ADAPTORS

NPT/NPSM fittings ▪ Conexiones NPT/NPSM ▪ Armaturen NPT/NPSM ▪ Embouts NPT/NPSM

| 68



Z69361

Z69161

WELDING
FITTINGS

SAE Flanges ▪ Bridas SAE ▪ SAE-Flansche ▪ Brides SAE

| 68



Z69282

Z69283

Z69284

INDUSTRIAL
FITTINGS

BSP fittings ▪ Conexiones BSP ▪ Armaturen BSP ▪ Embouts BSP

| 69



Z69510

Z69112

Z69517

Z69518

ACCESSORIES

CONTROL
COMPONENTS

FLOW
MEASURING

TRALE LOK

One piece fittings R7/R8 & Elastomer Braid of steel wire

Conexiones una sola pieza R7/ R8/ Elastómero malla metálica
Einteilige Armaturen R7/ R8 und Elastomer/Metallumfl.
Embouts pré-sertis R7/R8 et Elastomère tresse métallique

37° JIC One piece fittings R7/R8 ▪ Conexiones una sola pieza R7/R8 JIC 37° ▪ Einteilige Armaturen R7/R8 JIC 37° ▪ Embouts pré-sertis R7/R8 JIC 37°

70



87242

87138

87140

87142

87139

ORFS One piece fittings R7/R8 ▪ Conexiones una sola pieza R7/R8 ORFS ▪ Einteilige Armaturen R7/R8 ORFS ▪ Embouts pré-sertis R7/R8 ORFS

71



87900

87907

87912

87908

NPT-NPSM One piece fittings R7/R8 ▪ Conexiones una sola pieza R7/R8 NPT-NPSM ▪ Einteilige Armaturen R7/R8 NPT-NPSM ▪ Embouts pré-sertis R7/R8 NPT-NPSM

72



87361

87262

87161

87261

87263

Metric One piece fittings R7/R8 ▪ Conexiones una sola pieza R7/R8 Métricas ▪ Einteilige Armaturen R7/R8 metr. ▪ Embouts pré-sertis R7/R8 Métriques

73



87804

87305

87203

87306

BSP One piece fittings R7/R8 ▪ Conexiones una sola pieza R7/R8 BSP ▪ Einteilige Armaturen R7/R8 BSP ▪ Embouts pré-sertis R7/R8 BSP

74



87400

87107

87112

87100

87108

One piece fittings for Smooth PTFE/ R14

Conexiones una sola pieza PTFE Liso / R14
Einteilige Armaturen PTFE-Glattschlauch/ R14
Embouts pré-sertis pour PTFE lisse/ R14

PIPE
FITTINGS

37° JIC One piece fittings smooth PTFE / R14 ▪ Conexiones una sola pieza PTFE liso / R14 JIC 37° ▪ Einteilige Armaturen PTFE-Glattschlauch / R14 JIC 37° ▪ Embouts pré-sertis PTFE lisse / R14 JIC 37°

75



86242 86138 86140 86142 86139

PIPE
FITTINGS II

ORFS One piece fittings smooth PTFE / R14 ▪ Conexiones una sola pieza PTFE liso / R14 ORFS ▪ Einteilige Armaturen PTFE-Glattschlauch / R14 ORFS ▪ Embouts pré-sertis PTFE lisse / R14 ORFS

76



86900 86907 86912 86908

ADAPTORS

NPT-NPSM One piece fittings smooth PTFE / R14 ▪ Conexiones una sola pieza PTFE liso/ R14 NPT-NPSM ▪ Einteilige Armaturen PTFE-Glattschlauch / R14 NPT-NPSM ▪ Embouts pré-sertis PTFE lisse / R14 NPT-NPSM

77



86361 86262 86161 86261 86263

WELDING
FITTINGS

Metric One piece fittings smooth PTFE / R14 ▪ Conexiones una sola pieza PTFE liso / R14 Métricas ▪ Einteilige Armaturen PTFE-Glattschlauch / R14 metr. ▪ Embouts pré-sertis PTFE lisse / R14 Métriques

78



86804 86305 86203 86306

INDUSTRIAL
FITTINGS

BSP One piece fittings smooth PTFE / R14 ▪ Conexiones una sola pieza PTFE liso / R14 BSP ▪ Einteilige Armaturen PTFE-Glattschlauch / R14 BSP ▪ Embouts pré-sertis PTFE lisse/ R14 BSP

79



86400 86107 86112 86100 86108

ACCESSORIES

One piece fittings standpipe / R14 ▪ Conexiones una sola pieza PTFE liso / R14 Espiga Lisa ▪ Einteilige Armaturen PTFE-Glattschlauch / R14 Rohrstützen RS ▪ Embouts pré-sertis PTFE lisse / R14 embout lisse

79



86159

CONTROL
COMPONENTS

FLOW
MEASURING

TRALE LOK

One piece fittings for convoluted PTFE

Conexiones una sola pieza PTFE Corrugado
Einteilige Armaturen PTFE-Wellschlauch
Embouts pré-sertis pour PTFE convoluté

One piece fittings for convoluted PTFE JIC 37° ▪ Conexiones una sola pieza PTFE Corrugado JIC 37° ▪ Einteilige Armaturen PTFE-Wellschlauch JIC 37° ▪ Embouts pré-sertis pour PTFE convoluté JIC 37°

80



85242 85138 85140 85142 85139

One piece fittings for convoluted PTFE ORFS ▪ Conexiones una sola pieza PTFE Corrugado ORFS ▪ Einteilige Armaturen PTFE-Wellschlauch ORFS ▪ Embouts pré-sertis pour PTFE convoluté ORFS

81



85900 85907 85912 85908

One piece fittings for convoluted PTFE NPT-NPSM ▪ Conexiones una sola pieza PTFE Corrugado NPT-NPSM ▪ Einteilige Armaturen PTFE-Wellschlauch NPT-NPSM ▪ Embouts pré-sertis pour PTFE convoluté NPT-NPSM

82



85361 85262 85161 85261 85263

One piece fittings for convoluted PTFE Metrical ▪ Conexiones una sola pieza PTFE Corrugado Métricas ▪ Einteilige Armaturen PTFE-Wellschlauch metr. ▪ Embouts pré-sertis pour PTFE convoluté Métriques

83



85804 85305 85203 85306

One piece fittings for convoluted PTFE BSP ▪ Conexiones una sola pieza PTFE Corrugado BSP ▪ Einteilige Armaturen PTFE-Wellschlauch BSP ▪ Embouts pré-sertis pour PTFE convoluté BSP







84



85400 85107 85112 85100 85108

Reusable series

Conexiones Reusables
Schraubarmaturen
Embouts série récupérable

PIPE FITTINGS	Reusable One Piece fittings ▪ Conexiones una sola pieza Reusables ▪ Einteilige Wiederverwendbare Armaturen ▪ Embouts série récupérable 1 pièce	85
	 <p>Z3J...R2T Z2NPT...R2T</p>	
PIPE FITTINGS II	Crimping ferrules ▪ Casquillos reusables ▪ Wiederverwendbare Pressfassungen ▪ Jupes à sertir	85
	 <p>Z1G...R1T Z1G...R2T</p>	
ADAPTORS	Reusable BSP ▪ Conexiones BSP ▪ Wiederverwendbare Armaturen BSP ▪ Récuperables BSP	85
	 <p>Z3G Z90G Z2G</p>	
WELDING FITTINGS	Reusable JIC 37° ▪ Conexiones JIC 37° ▪ Wiederverwendbare Armaturen JIC 37 ▪ Récuperables JIC 37°	86
	 <p>Z3J Z2J Z3J90 Z3J45</p>	
INDUSTRIAL FITTINGS	Reusable NPT ▪ Conexiones NPT ▪ Wiederverwendbare Armaturen NPT ▪ Récuperables NPT	86
	 <p>Z2NPT</p>	
ACCESSORIES	Reusable Metric ▪ Conexiones Métricas ▪ Wiederverwendbare Metrischen Armaturen ▪ Récuperables Métriques	86
	 <p>ZE</p>	
CONTROL COMPONENTS	Reusable R5 ▪ Conexiones R5 ▪ Wiederverwendbare Armaturen R5 ▪ Récuperables R5	87
	 <p>Z3J...R5 Z3J90...R5 Z2P...R5 Z3J45...R5</p>	
FLOW MEASURING		
TRALE LOK		

Push-On Fittings

Conexiones Push-On
Aufsteck-Armaturen
Embouts Push-On

Push-on BSP fittings ▪ Conexiones Push-On BSP ▪ Aufsteck-Armaturen BSP ▪ Embouts Push-on BSP

88



89100

89112

Push-on 37° JIC fittings ▪ Conexiones Push-On JIC 37° ▪ Aufsteck-Armaturen JIC 37° ▪ Embouts Push-on JIC 37°

88



89142

89140

Push-on NPT fittings ▪ Conexiones Push-On NPT ▪ Aufsteck-Armaturen NPT ▪ Embouts Push-on NPT

88



89161

Push-on Metric fittings ▪ Conexiones Push-On Métricas ▪ Aufsteck-Armaturen metr. DIN 2383 ▪ Embouts Push-on Métriques

88



89804

89203

High pressure 700 bar fittings

Conexiones Alta Presión (700 bar)

Armaturen Hochdruck (700bar)

Embouts haute pression 700 bar

PIPE
FITTINGS

Ferrules ▪ Casquillos para prensar ▪ Pressfassungen ▪ Jupes à sertir

| 89



Z71012

PIPE
FITTINGS II

BSP Fittings ▪ Conexiones BSP ▪ Armaturen BSP ▪ Embouts BSP

| 89



Z74100

Z74112

ADAPTORS

NPSM - NPT Fittings ▪ Conexiones NPSM - NPT ▪ Armaturen NPSM - NPT ▪ Embouts NPSM - NPT

| 89



Z74261

Z74161

WELDING
FITTINGS

JIC 37° Fittings ▪ Conexiones JIC 37° ▪ Armaturen JIC 37° ▪ Embouts JIC 37°

| 89



Z74142

Z74140

INDUSTRIAL
FITTINGS

Metric Fittings ▪ Conexiones Métricas ▪ Metr. Armaturen ▪ Embouts métriques

| 89



Z74804

Z74203

ACCESSORIES

CONTROL
COMPONENTS

FLOW
MEASURING

TRALE LOK

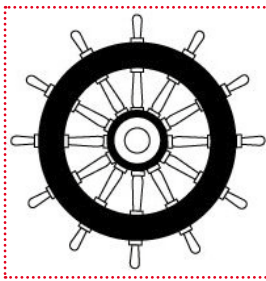

Mangueras/Hoses:

TrAle® **TrAle® GOLD**

Mangueras/Hoses:



**CONEXIONES FABRICADAS POR
FITTINGS MANUFACTURED BY**

DICSA

CERTIFIED
ISO 9001
ISO 14001



SUSTAINABLE
DEVELOPMENT
GOALS

ACIE
AGENCIA DE CERTIFICACIÓN
EN INNOVACIÓN ESPAÑOLA

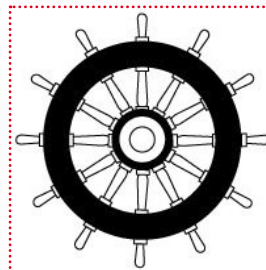

Standard series

Conexiones Standard
Standardserie
Embouts série standard

Ferrules R1AT/R2AT/1SN/2SN/R16/2SC/3TE

Casquillos R1AT/R2AT/ 1SN/2SN/ R16/2SC/3TE

Pressfassungen R1AT/R2AT/1SN/2SN/
R16/2SC/3TE

Jupes R1AT/R2AT/1SN/2SN/R16/2SC/3TE



DN	Referencia Part n°	€
3/16" -R1AT	810200300*	16,02
3/16" -R2AT	810300300*	11,85
3/16" NEW	ZPF221200300	13,94
1/4"	ZPF221200400	8,44
5/16"	ZPF221200500	9,47
3/8"	ZPF221200600	10,67
1/2"	ZPF221200800	12,78
5/8"	ZPF221201000	17,05
3/4"	ZPF221201200	22,70
1"	ZPF221201600	34,07
1"1/4	ZPF221202000	61,24
1"1/2	ZPF221202400	76,81
2"	ZPF221203200	121,60
2"1/2	ZPF221204000	154,43
3"	ZPF221204800	284,93

* Until end of stock / Hasta fin de existencias / Bis zum Ende des Lagerbestandes / Jusqu'à la fin du stock

Ferrules R1A-1ST

Casquillos R1A-1ST

Pressfassungen R1A-1ST

Jupes R1A-1ST

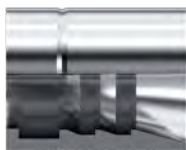

DN	Referencia Part n°	€
3/16"	820030300	10,37
1/4"	820030400	10,09
5/16"	820030500	10,99
3/8"	820030600	13,66
1/2"	820030800	15,34
5/8"	820031000	19,18
3/4"	820031200	23,63
1"	820031600	34,50
1"1/4	820032000	61,04
1"1/2	820032400	82,50
2"	820033200	133,10

Ferrules R4

Casquillos R4

Pressfassungen R4

Jupes R4



DN	Referencia Part n°	€
3/4"	ZPF221201200R4	24,80

For other sizes, please check out the crimping table on our website. / Para otras medidas, consultar tablas de prensado en nuestra web. / Für andere DN Größe, überprüfen Sie bitte die Pressmaßtabelle auf unserer Webseite. / Pour les autres dimensions, voir tableau de sertissage disponible sur notre site web.

Ferrules 1SC/1SN/2SC/R6/2TE/R17

Casquillos 1SC/1SN/2SC/R6/2TE/R17

Pressfassungen 1SC/1SN/2SC/R6/2TE/R17

Jupes 1SC/1SN/2SC/R6/2TE/R17



DN	Referencia Part n°	€
1/4"	ZSC21120400	8,79
5/16"	ZSC21120500	11,13
3/8"	ZSC21120600	10,68
1/2"	ZSC21120800	13,48
5/8"	ZSC21121000	16,62
3/4"	ZSC21121200	28,85
1"	ZSC21121600	35,00

Ferrules R2A-2ST/4SP-R9R / R12

Casquillos R2A-2ST/4SP-R9R / R12

Pressfassungen R2A-2ST/4SP-R9R / R12

Jupes R2A-2ST/4SP-R9R / R12



DN	Referencia Part n°	€
3/16" - R2A	820060300	9,99
1/4"	ZPF122400400	10,32
5/16"	ZPF122400500	10,57
3/8"	ZPF122400600	12,25
1/2"	ZPF122400800	13,11
5/8"	ZPF122401000	19,20
3/4"	ZPF122401200	20,91
1"	ZPF122401600	34,50
1"1/4	ZPF122402000	66,64
1"1/2	ZPF122402400	78,93
2"	ZPF122403200	122,06

Ferrules 3SP/4SP/R12/4SH non skive

Casquillos 3SP/4SP/R12/4SH no pelar

Pressfassungen 3SP/4SP/R12/4SH ohne Schälung

Jupes 3SP/4SP/R12/4SH sans dénudage



DN	Referencia Part n°	€
3/8"	ZPF222400600	13,90
1/2"	ZPF222400800	15,93
5/8"	ZPF222401000	25,13
3/4"	ZPF222401200	24,02
1"	ZPF222401600	39,93
1"1/4	ZPF222402000	65,57
1"1/2	ZPF222402400	101,01
2"	ZPF222403200	140,20

Standard series

Conexiones Standard
Standardserie
Embouts série standard

Ferrules R7/R8 and metallic braid / R6

Casquillos R7/R8 y elastómero malla metálica / R6
Pressfassungen R7/R8 und Elastomer/Metallumfl.
/ R6

Jupes R7/R8 et tresse métallique / R6



DN	Referencia Part n°	€
1/8"	810140200	8,53
3/16"	810140300	7,28
1/4"	810140400	8,00
5/16"	810140500	8,77
3/8"	810140600	9,32
1/2"	810140800	11,51
5/8"	810141000	17,07
3/4"	810141200	16,41
1"	810141600	26,16

Ferrules for Ecology hose and Sewer Jetting hose

Casquillos para mangueras Ecology y limpieza de alcantarillas

Pressf. für Schlauchtyp ECOLOGY und Abflussreinigung

Jupes pour tuyau Ecology et tuyau Hydrocurage



DN	Referencia Part n°	€
3/4"	Z212001200	31,22
1"	Z212001600	51,62
1"1/4	Z212002000	75,70

Ferrules for smooth PTFE

Casquillos PTFE Liso

Pressfassungen für PTFE-Glattschläuche

Jupes PTFE lisse



DN	Referencia Part n°	€
1/8"	810400100	9,21
3/16"	810400300	8,71
1/4"	810400400	6,31
5/16"	810400500	7,17
3/8"	810400600	7,16
1/2"	810400800	9,22
5/8"	810401000	12,62
3/4"	810401200	14,18
1"	810401600	22,72

Ferrules for convoluted PTFE

Casquillos PTFE Corrugado

Pressfassungen für PTFE-Wellschläuche mit Umfl.

Jupes PTFE convoluté



DN	Referencia Part n°	€
1/4"	810410400	7,19
5/16"	810410500	9,10
3/8"	810410600	9,05
1/2"	810410800	10,76
5/8"	810411000	15,76
3/4"	810411201	17,61
1"	810411600	26,46
1"1/4	810412000	41,39
1"1/2	810412400	55,89
2"	810413200	88,78
2"1/2	810414000	145,15

Ferrules for double braid smooth PTFE

Casquillos PTFE Liso doble malla

Pressfassungen für PTFE-Glattschläuche Doppelgeflecht

Jupes PTFE lisse double tresse



DN	Referencia Part n°	€
1/4"	810450400	10,29
3/8"	810450600	15,26

For other sizes, please check out the crimping table on our website. / Para otros tamaños, consultar tabla de prensado en nuestra web. / Für andere DN Größe, überprüfen Sie bitte die Pressmaßstabelle auf unserer Webseite. / Pour les autres dimensions, voir tableau de sertissage disponible sur notre site web.

Standard series

Conexiones Standard
Standardserie
Embouts série standard

Ferrules for smooth PTFE, smooth profile

Casquillos PTFE Liso, perfil liso

Pressfassungen für PTFE-Glattschläuche, glattes Profil

Jupes PTFE lisse, profil lisse



Ferrules for convoluted PTFE, smooth profile

Casquillos PTFE Corrugado, perfil liso

Pressfassungen für PTFE-Wellschläuche, glattes Profil

Jupes PTFE convoluté, profil lisse



DN	Referencia Part n°	€
1/4"	880400400	5,65
5/16"	880400500	7,08
3/8"	880400600	6,66
1/2"	880400800	8,15
5/8"	880401000	17,01

DN	Referencia Part n°	€
1/4"	880410400	6,44
5/16"	880410500	7,28
3/8"	880410600	6,88
1/2"	880410800	9,08
5/8"	880411000	13,34
3/4"	880411200	15,67

CASQUILLOS PERFIL LISO

FERRULES WITH SMOOTH PROFILE

- FACIL MONTAJE
- EASY ASSEMBLY
- VALIDO PARA CONEXIONES DE 1 Y 2 PIEZAS
- SUITABLE FOR 1 & 2 PIECE FITTINGS

Standard series

Conexiones Standard
Standardserie
Embouts série standard

BSP Swivel female 60° cone

Hembras giratorias rectas rosca BSP cono 60°

Dichtkopf mit BSP Ü-Mutter DKR

Femelle gaz cylindrique BSP 60°



DN	ROSCA THREAD	Referencia Part n°	€
3.2 mm	1/8" BSP	841000201	16,62
1/8"	1/8" BSP	841000202	15,88
3/16"	1/8" BSP	841000203	14,04
1/4"	1/8" BSP	841000204	13,73
3/16"	1/4" BSP	841000403	14,05
1/4"	1/4" BSP	841000404	10,18
5/16"	1/4" BSP	841000405	13,24
3/8"	1/4" BSP	841000406	15,24
1/4"	3/8" BSP	841000604	14,34
5/16"	3/8" BSP	841000605	13,84
3/8"	3/8" BSP	841000606	12,26
1/2"	3/8" BSP	841000608	14,88
1/4"	1/2" BSP	NEW 841000804	19,66
3/8"	1/2" BSP	841000806	16,39
1/2"	1/2" BSP	841000808	15,11
5/8"	1/2" BSP	841000810	23,02
1/2"	5/8" BSP	841001008	28,21
5/8"	5/8" BSP	841001010	31,51
1/2"	3/4" BSP	841001208	27,45
5/8"	3/4" BSP	841001210	25,17
3/4"	3/4" BSP	841001212	24,54
5/8"	1" BSP	841001610	49,26
3/4"	1" BSP	841001612	40,66
1"	1" BSP	841001616	39,23
1"	1"1/4 BSP	841002016	66,73
1"1/4	1"1/4 BSP	841002020	68,68
1"1/4	1"1/2 BSP	841002420	106,63
1"1/2	1"1/2 BSP	841002424	81,89
1"1/2	2" BSP	841003224	168,33
2"	2" BSP	841003232	151,71
2"	2"1/2 BSP	841004032	385,58
2"1/2	2"1/2 BSP	841004040	380,42
3"	3" BSP	841004848	426,63

BSP Swivel female 60° cone with o-ring

Hembras giratorias rectas rosca BSP cono 60° con junta tórica

Dichtkopf mit BSP Ü-Mutter DKR mit O-Ring

Femelle gaz cylindrique BSP 60° avec o-ring



DN	ROSCA THREAD	Referencia Part n°	€
1/4"	1/4" BSP	841100404	14,62
3/8"	3/8" BSP	841100606	15,21
3/8"	1/2" BSP	841100806	21,79
1/2"	1/2" BSP	841100808	17,56
5/8"	1/2" BSP	841100810	30,57
1/2"	3/4" BSP	841101208	30,36
5/8"	3/4" BSP	841101210	34,97
3/4"	3/4" BSP	841101212	24,88
1"	1" BSP	841101616	45,99
1"1/4	1"1/4 BSP	841102020	79,07
1"1/2	1"1/2 BSP	841102424	95,70
2"	2" BSP	841103232	202,06

BSP Swivel female flat seat

Hembras giratorias rectas rosca BSP asiento plano

Dichtkopf mit BSP Ü-Mutter flachdichtend DKR-FLD

Femelle fond plat BSP



DN	ROSCA THREAD	Referencia Part n°	€
1/4"	1/4" BSP	842000404	11,98
1/4"	3/8" BSP	842000604	18,01
5/16"	3/8" BSP	842000605	16,52
3/8"	3/8" BSP	842000606	13,70
1/2"	3/8" BSP	842000608	19,70
1/4"	1/2" BSP	842000804	25,26
3/8"	1/2" BSP	842000806	18,64
1/2"	1/2" BSP	842000808	17,61
1/2"	3/4" BSP	842001208	30,70
5/8"	3/4" BSP	842001210	27,58
3/4"	3/4" BSP	842001212	26,56
5/8"	1" BSP	842001610	45,72
3/4"	1" BSP	842001612	46,35
1"	1" BSP	842001616	43,44
1"	1"1/4 BSP	842002016	71,78
1"1/4	1"1/4 BSP	842002020	66,70
1"1/2	1"1/2 BSP	842002424	88,02
2"	2" BSP	842003232	164,06

Double hexagonal BSP Swivel female cone 60°

Hembras giratorias recta rosca BSP cono 60° doble hexagonal

Dichtkopf mit BSP Ü-Mutter DKR doppelt 6 kt

Femelle BSP cône 60° double hexagonal



DN	ROSCA THREAD	Referencia Part n°	€
1/4"	1/4" BSP	844000404	19,68
5/16"	3/8" BSP	844000605	23,18
3/8"	3/8" BSP	844000606	21,74
1/2"	1/2" BSP	844000808	22,39
3/4"	3/4" BSP	844001212	43,10
1"	1" BSP	844001616	58,03
1"1/4	1"1/4 BSP	844002020	86,77
1"1/2	1"1/2 BSP	844002424	135,67
2"	2" BSP	844003232	243,24

Standard series

Conexiones Standard
Standardserie
Embouts série standard

BSP Swivel female 60° cone (90° Elbow)

Hembras giratorias 90° rosca BSP cono 60°

Dichtkopf mit BSP Ü-Mutter 60° DKR 90°

Coude 90° femelle gaz cyl. BSP 60°



BSP Swivel female 60° cone (45° Elbow)

Hembras giratorias 45° rosca BSP cono 60°

Dichtkopf mit BSP Ü-Mutter 60° DKR kon. 45°

Coude 45° femelle gaz cyl. BSP 60°



DN	ROSCA THREAD	Referencia Part n°	€
3/16"	1/8" BSP	841070203*	32,14
1/4"	1/8" BSP	841070204	25,21
3/16"	1/4" BSP	841070403	23,15
1/4"	1/4" BSP	841070404	17,72
5/16"	1/4" BSP	841070405*	36,38
3/8"	1/4" BSP	841070406	27,52
1/4"	3/8" BSP	841070604	25,30
5/16"	3/8" BSP	841070605	25,80
3/8"	3/8" BSP	841070606	20,65
1/2"	3/8" BSP	841070608	46,88
1/4"	1/2" BSP	841070804	39,33
3/8"	1/2" BSP	841070806	33,59
1/2"	1/2" BSP	841070808	25,43
5/8"	5/8" BSP	841071010	54,56
1/2"	3/4" BSP	841071208	45,48
5/8"	3/4" BSP	841071210	49,76
3/4"	3/4" BSP	841071212	47,52
3/4"	1" BSP	841071612	70,11
1"	1" BSP	841071616	74,39
1"	1" 1/4 BSP	841072016	167,45
1" 1/4"	1" 1/4 BSP	841072020	127,42
1" 1/2"	1" 1/2 BSP	841072424	194,55
2"	2" BSP	841073232	361,81

*Welded piece / *Pieza soldada / *Geschweißte stück / *Pièce soudé

DN	ROSCA THREAD	Referencia Part n°	€
3/16"	1/4" BSP	841080403	23,15
1/4"	1/4" BSP	841080404	17,72
1/4"	3/8" BSP	841080604	25,30
5/16"	3/8" BSP	841080605	25,80
3/8"	3/8" BSP	841080606	20,65
1/4"	1/2" BSP	841080804	39,33
3/8"	1/2" BSP	841080806	33,60
1/2"	1/2" BSP	841080808	25,43
5/8"	5/8" BSP	841081010	54,56
1/2"	3/4" BSP	841081208	45,48
5/8"	3/4" BSP	841081210	49,76
3/4"	3/4" BSP	841081212	47,52
3/4"	1" BSP	841081612	70,11
1"	1" BSP	841081616	74,39
1"	1" 1/4 BSP	841082016	167,45
1" 1/4"	1" 1/4 BSP	841082020	127,42
1" 1/2"	1" 1/2 BSP	841082424	194,55
2"	2" BSP	841083232	361,81

BSP Swivel female flat seat (45° Elbow)

Hembras giratorias 45° rosca BSP asiento plano

Dichtkopf mit BSP Ü-Mutter 45° flachdichtend
DKR-FLD

Coude 45° femelle fond plat BSP



BSP Swivel female flat seat (90° Elbow)

Hembras giratorias 90° rosca BSP asiento plano

Dichtkopf mit BSP Ü-Mutter 90° Bogen
flachdichtend DKR-FLD

Coude 90° femelle fond plat BSP



DN	ROSCA THREAD	Referencia Part n°	€
1/4"	1/4" BSP	842070404	24,17
5/16"	3/8" BSP	842070605	29,18
3/8"	3/8" BSP	842070606	26,85
1/2"	1/2" BSP	842070808	32,14
3/4"	3/4" BSP	842071212	51,38
3/4"	1" BSP	842071612	78,17
1"	1" BSP	842071616	80,01
1" 1/4"	1" 1/4 BSP	842072020	152,04
1" 1/2"	1" 1/2 BSP	842072424	196,72
2"	2" BSP	842073232	471,43

DN	ROSCA THREAD	Referencia Part n°	€
1/4"	1/4" BSP	842080404	24,17
5/16"	3/8" BSP	842080605	29,18
3/8"	3/8" BSP	842080606	26,85
3/8"	1/2" BSP	842080806	36,16
1/2"	1/2" BSP	842080808	32,14
3/4"	3/4" BSP	842081212	51,38
3/4"	1" BSP	842081612	78,17
1"	1" BSP	842081616	80,01
1" 1/4"	1" 1/4 BSP	842082020	152,04
1" 1/2"	1" 1/2 BSP	842082424	196,72
2"	2" BSP	842083232	471,43

BSP swivel female 60° (90° Compact Elbow)

Hembras giratorias 90° compactas rosca BSP cono 60°

Dichtkopf BSP 60° kon. DKR einteilig 90°

Coude femelle 90° compact BSP cône 60°



DN	ROSCA THREAD	Referencia Part n°	€
1/4"	1/4" BSP	841270404	41,07
3/8"	3/8" BSP	841270606	42,93
1/2"	1/2" BSP	841270808	60,19
3/4"	3/4" BSP	841271212	86,08
1"	1" BSP	841271616	132,57

Standard series

Conexiones Standard
Standardserie
Embouts série standard

BSP Swivel female 60° cone with o-ring (90° Elbow)

Hembras giratorias 90° rosca BSP cono 60° con junta tórica

Dichtkopf mit BSP Ü-Mutter 60° kon. 90° mit Dichtung DKR

Coude 90° femelle gaz cyl. BSP 60° avec o-ring



DN	ROSCA THREAD	Referencia Part n°	€
1/4"	1/4" BSP	841170404	25,09
3/8"	3/8" BSP	841170606	29,39
3/8"	1/2" BSP	841170806	38,49
1/2"	1/2" BSP	841170808	33,42
1/2"	3/4" BSP	841171208	58,70
5/8"	3/4" BSP	841171210	53,50
3/4"	3/4" BSP	841171212	50,51
1"	1" BSP	841171616	86,17
1"1/4	1"1/4 BSP	841172020	160,68
1"1/2	1"1/2 BSP	841172424	221,74
2"	2" BSP	841173232	440,91

BSP Swivel female 60° cone with o-ring (45° Elbow)

Hembras giratorias 45° rosca BSP cono 60° con junta tórica

Dichtkopf mit BSP Ü-Mutter 60° mit O'Ring 45° DKR kon.

Coude 45° femelle gaz cyl. BSP 60° avec o-ring



DN	ROSCA THREAD	Referencia Part n°	€
1/4"	1/4" BSP	841180404	25,09
3/8"	3/8" BSP	841180606	29,39
3/8"	1/2" BSP	841180806	38,49
1/2"	1/2" BSP	841180808	33,42
1/2"	3/4" BSP	841181208	58,70
5/8"	3/4" BSP	841181210	53,50
3/4"	3/4" BSP	841181212	50,51
1"	1" BSP	841181616	86,17
1"1/4	1"1/4 BSP	841182020	160,69
1"1/2	1"1/2 BSP	841182424	221,74
2"	2" BSP	841183232	440,91

O'ring for swivel female BSP FKM green

Juntas para hembra giratoria BSP FKM verde

Dichtungen FKM grün für DKR

Joint torique pour femelle tournante BSP FKM vert



ROSCA THREAD	TAMAÑO SIZE	Referencia Part n°	€
1/4" BSP	6X1	JTVBSP04	0,17
3/8" BSP	8.1X1.6	JTVBSP06	0,18
1/2" BSP	12.1X1.6	JTVBSP08	0,20
5/8" BSP	13.1X1.6	JTVBSP10	0,20
3/4" BSP	17.1X1.6	JTVBSP12	0,23
1" BSP	22.1X1.6	JTVBSP16	0,31
1"1/4 BSP	29.1X1.6	JTVBSP20	0,46
1"1/2 BSP	35.1X1.6	JTVBSP24	0,60
2" BSP	47.35X1.78	JTVBSP32	0,88

Standard series

Conexiones Standard
Standardserie
Embouts série standard

BSP Male flat seat

Machos rosca cilíndrica BSP asiento plano

BSP Außengewinde flachdichtend AGR FLACH

Mâle BSP fond plat



Male BSPT tapered

Macho rosca cónica BSPT cono 60°

Außengewinde BSPT Kegelig

Mâle gaz conique BSPT 60°



DN	ROSCA THREAD	Referencia Part n°	€
3/16"	1/4" BSP	842120403	20,48
1/4"	1/4" BSP	842120404	15,41
5/16"	3/8" BSP	842120605	21,33
3/8"	3/8" BSP	842120606	18,24
1/2"	3/8" BSP	842120608	24,56
3/8"	1/2" BSP	842120806	25,52
1/2"	1/2" BSP	842120808	20,03
5/8"	5/8" BSP	842121010	38,95
3/4"	3/4" BSP	842121212	28,28
3/4"	1" BSP	842121612	67,69
1"	1" BSP	842121616	56,96
1"	1" 1/4 BSP	842122016	120,02
1" 1/4"	1" 1/4 BSP	842122020	115,34
1" 1/2"	1" 1/2 BSP	842122424	159,02
2"	2" BSP	842123232	192,47

DN	ROSCA THREAD	Referencia Part n°	€
1/4"	1/4" BSPT	841140404	12,13
5/16"	1/4" BSPT	841140405	18,56
3/8"	1/4" BSPT	841140406	16,85
1/4"	3/8" BSPT	841140604	21,29
5/16"	3/8" BSPT	841140605	19,04
3/8"	3/8" BSPT	841140606	13,25
1/2"	3/8" BSPT	841140608	18,95
3/8"	1/2" BSPT	841140806	25,82
1/2"	1/2" BSPT	841140808	15,56
5/8"	1/2" BSPT	841140810	26,12
3/4"	1/2" BSPT	841140812	35,83
1/2"	3/4" BSPT	841141208	38,05
5/8"	3/4" BSPT	841141210	31,00
3/4"	3/4" BSPT	841141212	26,08
3/4"	1" BSPT	841141612	51,32
1"	1" BSPT	841141616	45,31
1"	1" 1/4 BSPT	841142016	90,78
1" 1/4"	1" 1/4 BSPT	841142020	81,28
1" 1/4"	1" 1/2 BSPT	841142420	101,35
1" 1/2"	1" 1/2 BSPT	841142424	100,30
2"	2" BSPT	841143232	168,19

BSP Male-parallel 60° cone

Machos rosca cilíndrica BSP cono 60°

Außengewinde BSP NORM AGR

Mâle BSP cône 60°



DN	ROSCA THREAD	Referencia Part n°	€
3/16"	1/8" BSP	841120203	23,92
1/4"	1/8" BSP	841120204	19,23
3/16"	1/4" BSP	841120403	21,49
1/4"	1/4" BSP	841120404	12,57
5/16"	1/4" BSP	841120405	21,31
3/8"	1/4" BSP	841120406	20,52
1/4"	3/8" BSP	841120604	22,90
5/16"	3/8" BSP	841120605	21,28
3/8"	3/8" BSP	841120606	14,22
1/2"	3/8" BSP	841120608	19,29
3/8"	1/2" BSP	841120806	20,94
1/2"	1/2" BSP	841120808	19,13
5/8"	5/8" BSP	841121010	37,28
5/8"	3/4" BSP	841121210	37,79
3/4"	3/4" BSP	841121212	28,08
1"	3/4" BSP	NEW 841121216	38,58
3/4"	1" BSP	841121612	55,74
1"	1" BSP	841121616	54,99
1"	1" 1/4 BSP	841122016	99,26
1" 1/4"	1" 1/4 BSP	841122020	95,37
1" 1/4"	1" 1/2 BSP	841122420	142,07
1" 1/2"	1" 1/2 BSP	841122424	111,37
2"	1" 1/2 BSP	841122432	180,03
2"	2" BSP	841123232	189,43
2" 1/2"	2" 1/2 BSP	841124040	381,90

Standard series

Conexiones Standard
Standardserie
Embouts série standard

Double hexagonal NPSM Swivel female cone 60°

Hembras giratorias rectas rosca NPSM cono 60°
doble hexagonal

Dichtkopf mit Ü-Muttern NPSM kon. 60° doppelt
6 kt

Femelle NPSM cône 60° double hexagonal



DN	ROSCA THREAD	Referencia Part n°	€
1/4"	1/4" 18h NPSM	843610404	24,63
3/8"	3/8" 18h NPSM	843610606	25,34
1/2"	1/2" 14h NPSM	843610808	29,99
3/4"	3/4" 14h NPSM	843611212	44,31
1"	1" - 11 1/2h NPSM	843611616	69,66

NPSM Swivel female 60° cone

Hembras giratorias rectas rosca NPSM cono 60°

Dichtkopf mit NPSM Ü-Muttern kon. 60°

Femelle NPSM cône 60°



DN	ROSCA THREAD	Referencia Part n°	€
3/16"	1/4" 18h NPSM	842610403	19,19
1/4"	1/4" 18h NPSM	842610404	14,38
3/8"	3/8" 18h NPSM	842610606	15,07
3/8"	1/2" 14h NPSM	NEW 842610806	22,30
1/2"	1/2" 14h NPSM	842610808	21,45
3/4"	3/4" 14h NPSM	842611212	30,95
3/4"	1"-11 1/2h NPSM	842611612	57,14
1"	1"-11 1/2h NPSM	842611616	48,90
1"1/4"	1"1/4-11 1/2h NPSM	842612020	91,86
1"1/2"	1"1/2-11 1/2h NPSM	842612424	108,83

NPSM Swivel female 60° cone (90° Elbow)

Hembras giratorias 90° rosca NPSM cono 60°

Dichtkopf mit NPSM Ü-Mutter 60° kon. 90°

Coude 90° femelle NPSM cône 60°



DN	ROSCA THREAD	Referencia Part n°	€
1/4"	1/4" 18h NPSM	842620404	23,71
3/8"	3/8" 18h NPSM	842620606	27,49
1/2"	1/2" 14h NPSM	842620808	38,61
3/4"	3/4" 14h NPSM	842621212	56,06
1"	1"-11 1/2h NPSM	842621616	82,81

NPSM Swivel female 60° cone (45° Elbow)

Hembras giratorias 45° rosca NPSM cono 60°

Dichtkopf mit NPSM Ü-Mutter 60° kon. 45°

Coude 45° femelle NPSM cône 60°



DN	ROSCA THREAD	Referencia Part n°	€
1/4"	1/4" 18h NPSM	842630404	23,71
3/8"	3/8" 18h NPSM	842630606	27,49
1/2"	1/2" 14h NPSM	842630808	38,61
3/4"	3/4" 14h NPSM	842631212	56,06
1"	1"-11 1/2h NPSM	842631616	82,81

NPT Male pipe straight

Machos rosca cónica NPT

Außengewinde kon. NPT AGN

Embout mâle conique NPT (BRIGGS)



DN	ROSCA THREAD	Referencia Part n°	€
1/4"	1/8" NPT	841610204	17,11
3/16"	1/4" NPT	841610403	17,97
1/4"	1/4" NPT	841610404	11,38
5/16"	1/4" NPT	841610405	18,85
3/8"	1/4" NPT	841610406	19,22
1/4"	3/8" NPT	841610604	19,08
5/16"	3/8" NPT	841610605	21,26
3/8"	3/8" NPT	841610606	12,81
1/2"	3/8" NPT	841610608	23,66
1/4"	1/2" NPT	841610804	31,00
3/8"	1/2" NPT	841610806	25,27
1/2"	1/2" NPT	841610808	17,11
5/8"	1/2" NPT	841610810	23,00
3/4"	1/2" NPT	841610812	32,07
1/2"	3/4" NPT	841611208	35,41
5/8"	3/4" NPT	841611210	34,75
3/4"	3/4" NPT	841611212	27,09
1"	3/4" NPT	841611216	44,07
3/4"	1" NPT	841611612	52,75
1"	1" NPT	841611616	44,58
1"	1"1/4 NPT	841612016	87,26
1"1/4"	1"1/4 NPT	841612020	82,13
1"	1"1/2 NPT	841612416	119,79
1"1/4"	1"1/2 NPT	841612420	101,76
1"1/2"	1"1/2 NPT	841612424	95,51
2"	2" NPT	841613232	170,71

Swivel male NPT

Machos giratorios NPT

Außengewinde NPT

Mâle tournant NPT



DN	ROSCA THREAD	Referencia Part n°	€
1/4"	1/4" NPT	841650404	41,82
3/8"	3/8" NPT	841650606	42,59
3/8"	1/2" NPT	841650806	66,77
1/2"	1/2" NPT	841650808	46,48
3/4"	1/2" NPT	841650812	76,77
1/2"	3/4" NPT	841651208	79,40
3/4"	3/4" NPT	841651212	66,47
3/4"	1" NPT	841651612	105,41
1"	1" NPT	841651616	98,45

Standard series

Conexiones Standard
Standardserie
Embouts série standard

Double hexagonal JIC 37° Swivel female

Hembras giratorias recta JIC 37° doble hexagonal

Dichtkonus mit Ü-Mutter JIC 37° DKJ doppelt 6 kt

Femelle JIC 37° double hexagonal



DN	ROSCA THREAD	Referencia Part n°	€
3/16"	7/16" 20h UNF	842420703	18,70
1/4"	7/16" 20h UNF	842420704	14,30
5/16"	7/16" 20h UNF	842420705	23,88
3/8"	7/16" 20h UNF	842420706	28,31
1/4"	1/2" 20h UNF	842420804	19,85
5/16"	1/2" 20h UNF	842420805	24,58
3/8"	1/2" 20h UNF	842420806	24,03
1/4"	9/16" 18h UNF	842420904	22,01
5/16"	9/16" 18h UNF	842420905	24,29
3/8"	9/16" 18h UNF	842420906	16,62
3/8"	3/4" 16h UNF	842421206	21,22
1/2"	3/4" 16h UNF	842421208	19,22
5/8"	3/4" 16h UNF	842421210	27,71
3/4"	3/4" 16h UNF	842421212	41,24
1/2"	7/8" 14h UNF	842421408	29,13
5/8"	7/8" 14h UNF	842421410	31,65
3/4"	7/8" 14h UNF	842421412	41,65
1/2"	1 1/16" 12h UN	842421708	41,79
5/8"	1 1/16" 12h UN	842421710	38,61
3/4"	1 1/16" 12h UN	842421712	32,92
1"	1 1/16" 12h UN	842421716	53,02
3/4"	1 5/16" 12h UN	842422112	58,17
1"	1 5/16" 12h UN	842422116	50,90
1 1/4"	1 5/8" 12h UN	842422620	97,18
1 1/2"	1 7/8" 12h UN	842423024	127,56
2"	2 1/2" 12h UN	842424032	273,90

JIC 37° Swivel female

Hembras giratorias recta JIC 37°

Dichtkonus mit Ü-Mutter JIC 37°

Femelle droite JIC cône 37°



DN	ROSCA THREAD	Referencia Part n°	€
3.2 mm	7/16" 20h UNF	841420701	17,12
3/16"	7/16" 20h UNF	841420703	11,89
1/4"	7/16" 20h UNF	841420704	11,44
5/16"	7/16" 20h UNF	841420705	16,94
3/16"	1/2" 20h UNF	841420803	13,60
1/4"	1/2" 20h UNF	841420804	12,62
5/16"	1/2" 20h UNF	841420805	15,82
1/4"	9/16" 18h UNF	841420904	14,37
5/16"	9/16" 18h UNF	841420905	13,08
3/8"	9/16" 18h UNF	841420906	12,78
3/8"	3/4" 16h UNF	841421206	17,11
1/2"	3/4" 16h UNF	841421208	16,36
3/8"	7/8" 14h UNF	841421406	24,61
1/2"	7/8" 14h UNF	841421408	17,86
5/8"	7/8" 14h UNF	841421410	21,22
1/2"	1 1/16" 12h UN	841421708	34,03
5/8"	1 1/16" 12h UN	841421710	29,51
3/4"	1 1/16" 12h UN	841421712	24,89
1"	1 1/16" 12h UN	841421716	46,69
3/4"	1 5/16" 12h UN	841422112	39,80
1"	1 5/16" 12h UN	841422116	39,19
1"	1 5/8" 12h UN	841422616	69,66
1 1/4"	1 5/8" 12h UN	841422620	67,76
1 1/4"	1 7/8" 12h UN	841423020	121,92
1 1/2"	1 7/8" 12h UN	841423024	94,33
2"	2 1/2" 12h UN	841424032	186,53

JIC 37° Swivel female (90° Elbow)

Hembras giratorias 90° JIC 37°

Dichtkonus JIC 37° DKJ 90°

Coude 90° femelle JIC cône 37°



DN	ROSCA THREAD	Referencia Part n°	€
3/16"	7/16" 20h UNF	841380703	24,97
1/4"	7/16" 20h UNF	841380704	18,72
5/16"	7/16" 20h UNF	841380705	34,36
1/4"	1/2" 20h UNF	841380804	22,00
5/16"	1/2" 20h UNF	841380805	31,82
1/4"	9/16" 18h UNF	841380904	31,96
5/16"	9/16" 18h UNF	841380905	24,43
3/8"	9/16" 18h UNF	841380906	23,30
3/8"	3/4" 16h UNF	841381206	31,45
1/2"	3/4" 16h UNF	841381208	27,82
3/8"	7/8" 14h UNF	841381406	39,16
1/2"	7/8" 14h UNF	841381408	30,25
5/8"	7/8" 14h UNF	841381410	37,51
1/2"	1 1/16" 12h UN	841381708	49,86
5/8"	1 1/16" 12h UN	841381710	51,82
3/4"	1 1/16" 12h UN	841381712	49,37
3/4"	1 5/16" 12h UN	841382112	82,29
1"	1 5/16" 12h UN	841382116	77,51
1"	1 5/8" 12h UN	841382616	141,79
1 1/4"	1 5/8" 12h UN	841382620	125,63
1 1/4"	1 7/8" 12h UN	841383020	197,04
1 1/2"	1 7/8" 12h UN	841383024	200,95
2"	2 1/2" 12h UN	841384032	437,10

JIC 37° Swivel female (45° Elbow)

Hembras giratorias 45° JIC 37°

Dichtkonus JIC 37° DKJ 45°

Coude 45° femelle JIC cône 37°



DN	ROSCA THREAD	Referencia Part n°	€
3/16"	7/16" 20h UNF	841390703	24,97
1/4"	7/16" 20h UNF	841390704	18,72
1/4"	1/2" 20h UNF	841390804	22,00
5/16"	1/2" 20h UNF	841390805	31,82
1/4"	9/16" 18h UNF	841390904	31,96
5/16"	9/16" 18h UNF	841390905	24,43
3/8"	9/16" 18h UNF	841390906	23,30
3/8"	3/4" 16h UNF	841391206	31,45
1/2"	3/4" 16h UNF	841391208	27,82
3/8"	7/8" 14h UNF	841391406	39,16
1/2"	7/8" 14h UNF	841391408	30,25
5/8"	7/8" 14h UNF	841391410	37,51
5/8"	1 1/16" 12h UN	841391710	51,82
3/4"	1 1/16" 12h UN	841391712	49,37
3/4"	1 5/16" 12h UN	841392112	82,29
1"	1 5/16" 12h UN	841392116	77,51
1"	1 5/8" 12h UN	841392616	141,79
1 1/4"	1 5/8" 12h UN	841392620	125,63
1 1/4"	1 7/8" 12h UN	841393020	197,04
1 1/2"	1 7/8" 12h UN	841393024	200,95
2"	2 1/2" 12h UN	841394032	437,10

Standard series

Conexiones Standard
Standardserie
Embouts série standard

Male JIC 37°

Machos rosca JIC cono 37°

Außengewinde JIC 37° AGJ

Mâle fixe JIC cône 37°



DN	ROSCA THREAD	Referencia Part n°	€
3/16"	7/16" 20h UNF	841400703	21,01
1/4"	7/16" 20h UNF	841400704	16,19
1/4"	1/2" 20h UNF	841400804	16,79
5/16"	1/2" 20h UNF	841400805	17,32
1/4"	9/16" 18h UNF	841400904	22,12
5/16"	9/16" 18h UNF	841400905	22,20
3/8"	9/16" 18h UNF	841400906	22,44
1/4"	3/4" 16h UNF	841401204	31,39
3/8"	3/4" 16h UNF	841401206	18,17
1/2"	3/4" 16h UNF	841401208	20,54
3/8"	7/8" 14h UNF	841401406	25,97
1/2"	7/8" 14h UNF	841401408	19,34
5/8"	7/8" 14h UNF	841401410	27,10
5/8"	1"1/16 12h UN	841401710	35,98
3/4"	1"1/16 12h UN	841401712	35,06
1"	1"1/16 12h UN	841401716	42,41
3/4"	1"5/16 12h UN	841402112	53,56
1"	1"5/16 12h UN	841402116	52,90
1"	1"5/8 12h UN	841402616	90,41
1"1/4"	1"5/8 12h UN	841402620	93,72
1"1/2"	1"7/8 12h UN	841403024	107,75
2"	2"1/2 12h UN	841404032	251,15

Male JIC 37° with o'ring

Machos rosca JIC cono 37° con junta

Außengewinde JIC 37° AGJ mit Dichtung

Mâle fixe JIC cône 37° avec o'ring



DN	ROSCA THREAD	Referencia Part n°	€
1/4"	7/16" 20h UNF	841410704	19,01
3/8"	9/16" 18h UNF	841410906	22,80
1/2"	3/4" 16h UNF	841411208	24,01
3/4"	1"1/16 12h UN	841411712	44,66
1"	1"5/16 12h UN	841412116	62,64
1"1/4"	1"5/8 12h UN	841412620	109,54
1"1/2"	1"7/8 12h UN	841413024	155,54
2"	2"1/2 12h UN	841414032	386,15

JIC 37° Swivel female (90° Compact Elbow)

Hembras giratorias 90° compactas JIC 37°

Dichtkonus JIC 37° einteilig 90° DKJ

Coude femelle 90° compact JIC cône 37°



DN	ROSCA THREAD	Referencia Part n°	€
1/4"	7/16" 20h UNF	841370704	44,54
3/8"	9/16" 18h UNF	841370906	45,01
1/2"	3/4" 16h UNF	841371208	58,43
3/4"	1"1/16 12h UNF	841371712	82,78
1"	1"5/16 12h UNF	841372116	136,59

Standard series

Conexiones Standard
Standardserie
Embouts série standard

Metric female swivel L with o'ring 24° cone

Hembras giratorias rectas DKOL rosca Métrica cono 24°

Dichtkegel mit Ü-Mutter L und O-Ring DIN 20078 DKOL/DKOS

Femelle Métrique L avec o'ring cône 24°



Metric female swivel S with o'ring 24° cone

Hembras giratorias rectas DKOS rosca Métrica cono 24°

Dichtkegel mit Ü-Mutter S und O-Ring DIN 20078 DKOL/DKOS

Femelle Métrique S avec o'ring cône 24°



DN	TUBO PIPE	SERIE SERIES	ROSCA THREAD	Referencia Part n°	€
3/16"	6	L	M12x1.5	84804120603	12,97
1/4"	6	L	M12x1.5	84804120604	11,91
1/4"	8	L	M14x1.5	84804140804	10,74
5/16"	8	L	M14x1.5	84804140805	17,46
3/8"	8	L	M 14x1.5	84804140806	23,72
1/4"	10	L	M16x1.5	84804161004	12,35
5/16"	10	L	M16x1.5	84804161005	12,20
3/8"	10	L	M16x1.5	84804161006	14,38
1/4"	12	L	M18x1.5	84804181204	17,73
5/16"	12	L	M18x1.5	84804181205	16,43
3/8"	12	L	M18x1.5	84804181206	13,28
1/2"	12	L	M 18x1.5	84804181208	26,73
1/4"	15	L	M22x1.5	84804221504	22,22
5/16"	15	L	M22x1.5	84804221505	21,65
3/8"	15	L	M22x1.5	84804221506	18,70
1/2"	15	L	M22x1.5	84804221508	17,93
5/8"	15	L	M22x1,5	84804221510	35,90
3/8"	18	L	M26x1,5	84804261806	29,53
1/2"	18	L	M26x1.5	84804261808	26,75
5/8"	18	L	M26x1.5	84804261810	24,77
3/4"	18	L	M26x1.5	84804261812	43,17
1/2"	22	L	M30x2	84804302208	36,97
5/8"	22	L	M30x2	84804302210	38,86
3/4"	22	L	M30x2	84804302212	30,28
3/4"	28	L	M36x2	84804362812	58,65
1"	28	L	M36x2	84804362816	47,99
1"	35	L	M45x2	84804453516	85,25
1"1/4	35	L	M45x2	84804453520	67,81
1"1/4	42	L	M52x2	84804524220	132,13
1"1/2	42	L	M52x2	84804524224	101,83
2"	42	L	M52x2	84804524232	177,60

DN	TUBO PIPE	SERIE SERIES	ROSCA THREAD	Referencia Part n°	€
1/4"	6	S	M14x1.5	84804140604	17,11
1/4"	8	S	M16x1.5	84804160804	12,45
5/16"	8	S	M16x1.5	84804160805	19,54
3/8"	8	S	M16x1.5	84804160806	20,39
1/4"	10	S	M18x1.5	84804181004	14,60
5/16"	10	S	M18x1.5	84804181005	20,15
3/8"	10	S	M18x1.5	84804181006	21,73
1/4"	12	S	M20x1.5	84804201204	28,29
5/16"	12	S	M20x1.5	84804201205	17,66
3/8"	12	S	M20x1.5	84804201206	16,05
1/2"	12	S	M20x1.5	84804201208	26,77
5/16"	14	S	M22x1.5	84804221405	21,29
3/8"	14	S	M22x1.5	84804221406	21,66
1/2"	14	S	M22x1.5	84804221408	20,78
1/4"	16	S	M24x1.5	84804241604	26,26
5/16"	16	S	M24x1.5	84804241605	28,92
3/8"	16	S	M24x1.5	84804241606	23,77
1/2"	16	S	M24x1.5	84804241608	18,09
5/8"	16	S	M24x1.5	84804241610	28,86
1/2"	20	S	M30x2	84804302008	34,87
5/8"	20	S	M30x2	84804302010	27,83
3/4"	20	S	M30x2	84804302012	37,62
5/8"	25	S	M36x2	84804362510	53,49
3/4"	25	S	M36x2	84804362512	49,86
1"	25	S	M36x2	84804362516	63,85
3/4"	30	S	M42x2	84804423012	77,73
1"	30	S	M42x2	84804423016	66,80
1"1/4	38	S	M52x2	84804523820	112,16

Standard series

Conexiones Standard
Standardserie
Embouts série standard

Metric Male stud 24° cone

Machos rosca Métrica cono 24°

Gewindezapfen L/S DIN 20078 D/E CEL/CES

Mâle métrique cône 24°



DN	TUBO PIPE	SERIE SERIES	ROSCA THREAD	Referencia Part n°	€
1/4"	6	L	M12x1.5	84203120604	16,52
1/4"	8	L	M14x1.5	84203140804	14,34
1/4"	10	L	M16x1.5	84203161004	15,40
5/16"	10	L	M16x1.5	84203161005	18,78
3/8"	10	L	M16x1.5	84203161006	17,78
1/4"	12	L	M18x1.5	84203181204	20,37
5/16"	12	L	M18x1.5	84203181205	17,63
3/8"	12	L	M18x1.5	84203181206	12,09
3/8"	15	L	M22x1.5	84203221506	24,13
1/2"	15	L	M22x1.5	84203221508	17,98
1/2"	18	L	M26x1.5	84203261808	28,81
5/8"	18	L	M26x1.5	84203261810	24,23
3/4"	22	L	M30x2	84203302212	35,74
1"	28	L	M36x2	84203362816	53,30
1 1/4"	35	L	M45x2	84203453520	90,70
1 1/2"	42	L	M52x2	84203524224	136,16
1/4"	6	S	M14x1.5	84203140604	18,73
1/4"	8	S	M16x1.5	84203160804	20,02
1/4"	10	S	M18x1.5	84203181004	22,57
5/16"	10	S	M18x1.5	84203181005	27,54
3/8"	10	S	M18x1.5	84203181006	19,35
5/16"	12	S	M20x1.5	84203201205	25,09
3/8"	12	S	M20x1.5	84203201206	20,24
3/8"	14	S	M22x1.5	84203221406	24,58
1/2"	14	S	M22x1.5	84203221408	28,99
1/2"	16	S	M24x1.5	84203241608	20,98
5/8"	20	S	M30x2	84203302010	33,71
3/4"	20	S	M30x2	84203302012	43,65
3/4"	25	S	M36x2	84203362512	57,70
1"	25	S	M36x2	84203362516	66,32
1"	30	S	M42x2	84203423016	90,65
1 1/4"	38	S	M52x2	84203523820	139,36

Metric female swivel 24° / 60° cone

Hembras giratorias rectas rosca Métrica cono 24° / 60°

Dichtkegel mit Ü-Mutter metr. kon. 24° / 60° DKM

Femelle Métrique cône 24° / 60°



DN	TUBO PIPE	SERIE SERIES	ROSCA THREAD	Referencia Part n°	€
1/4"	8	L	M14x1.5	84404140804	15,84
1/4"	10	L	M16x1.5	84404161004	17,01
5/16"	10	L	M16x1.5	84404161005	18,82
3/8"	10	L	M16x1.5	84404161006	18,28
5/16"	12	L	M18x1.5	84404181205	20,78
3/8"	12	L	M18x1.5	84404181206	18,64
3/8"	15	L	M22x1.5	84404221506	26,18
1/2"	15	L	M22x1.5	84404221508	25,13
5/8"	18	L	M26x1.5	84404261810	30,92

Standard series

Conexiones Standard
Standardserie
Embouts série standard

Metric swivel female with o'ring 24° cone (90° Elbow)

Hembras giratorias DKO 90° Métricas cono 24°

Dichtkegel mit Ü-Mutter und O-Ring DIN 20078 90°
Bogen DKOL 90° /DKOS 90°

Coude 90° femelle Métrique cône 24° avec o'ring



Metric swivel female with o'ring 24° cone (45° Elbow)

Hembras giratorias DKO 45° Métricas cono 24°

Dichtkegel mit Ü-Mutter und O-Ring DIN 20078 45°
Bogen DKOL 45° /DKOS 45° kon.

Coude 45° femelle Métrique cône 24° avec o'ring



DN	TUBO PIPE	ROSCA THREAD	SERIE SERIES	Referencia Part n°	€
3/16"	6	M12x1.5	L	84305120603	24,30
1/4"	6	M12x1.5	L	84305120604	20,15
1/4"	8	M14x1.5	L	84305140804	19,18
5/16"	8	M14x1.5	L	84305140805	31,26
1/4"	10	M16x1.5	L	84305161004	22,49
5/16"	10	M16x1.5	L	84305161005	24,10
3/8"	10	M16x1.5	L	84305161006	24,73
1/4"	12	M18x1.5	L	84305181204	30,79
5/16"	12	M18x1.5	L	84305181205	31,94
3/8"	12	M18x1.5	L	84305181206	22,88
1/2"	12	M18x1.5	L	84305181208	35,14
3/8"	15	M22x1.5	L	84305221506	37,44
1/2"	15	M22x1.5	L	84305221508	28,83
5/8"	15	M22x1.5	L	84305221510	*
1/2"	18	M26x1.5	L	84305261808	44,08
5/8"	18	M26x1.5	L	84305261810	41,41
5/8"	22	M30x2	L	84305302210	65,12
3/4"	22	M30x2	L	84305302212	55,20
3/4"	28	M36x2	L	84305362812	90,35
1"	28	M36x2	L	84305362816	82,61
1" 1/4	35	M45x2	L	84305453520	136,91
1" 1/2	42	M52x2	L	84305524224	215,82
1/4"	6	M14x1.5	S	84305140604	27,96
1/4"	8	M16x1.5	S	84305160804	23,30
5/16"	8	M16x1.5	S	84305160805	28,48
1/4"	10	M18x1.5	S	84305181004	23,81
5/16"	10	M18x1.5	S	84305181005	39,16
3/8"	10	M18x1.5	S	84305181006	32,14
1/4"	12	M20x1.5	S	84305201204	31,66
5/16"	12	M20x1.5	S	84305201205	33,38
3/8"	12	M20x1.5	S	84305201206	27,53
1/2"	12	M20x1.5	S	84305201208	33,35
3/8"	14	M22x1.5	S	84305221406	37,68
1/2"	14	M22x1.5	S	84305221408	35,42
3/8"	16	M24x1.5	S	84305241606	33,03
1/2"	16	M24x1.5	S	84305241608	31,35
3/8"	20	M30x2	S	84305302006	63,59
1/2"	20	M30x2	S	84305302008	55,33
5/8"	20	M30x2	S	84305302010	50,12
3/4"	20	M30x2	S	84305302012	58,23
3/4"	25	M36x2	S	84305362512	81,16
1"	25	M36x2	S	84305362516	98,78
5/8"	30	M42x2	S	84305423010	119,64
3/4"	30	M42x2	S	84305423012	152,08
1"	30	M42x2	S	84305423016	119,94
1" 1/4	38	M52x2	S	84305523820	204,65

DN	TUBO PIPE	SERIE SERIES	ROSCA THREAD	Referencia Part n°	€
3/16"	6	L	M12x1.5	84306120603	24,30
1/4"	6	L	M12x1.5	84306120604	20,15
1/4"	8	L	M14x1.5	84306140804	19,18
5/16"	8	L	M14x1.5	84306140805	31,26
1/4"	10	L	M16x1.5	84306161004	22,49
5/16"	10	L	M16x1.5	84306161005	24,10
3/8"	10	L	M16x1.5	84306161006	24,73
1/4"	12	L	M18x1.5	84306181204	30,79
5/16"	12	L	M18x1.5	84306181205	31,94
3/8"	12	L	M18x1.5	84306181206	22,88
1/2"	12	L	M18x1.5	84306181208	35,14
3/8"	15	L	M22x1.5	84306221506	37,44
1/2"	15	L	M22x1.5	84306221508	28,83
5/8"	15	L	M22x1.5	NEW 84306221510	68,58
1/2"	18	L	M26x1.5	84306261808	44,08
5/8"	18	L	M26x1.5	84306261810	41,41
5/8"	22	L	M30x2	84306302210	65,12
3/4"	22	L	M30x2	84306302212	55,20
3/4"	28	L	M36x2	84306362812	90,35
1"	28	L	M36x2	84306362816	82,61
1" 1/4	35	L	M45x2	84306453520	136,91
1" 1/2	42	L	M52x2	84306524224	215,82
1/4"	6	S	M14x1.5	84306140604	27,96
1/4"	8	S	M16x1.5	84306160804	23,30
5/16"	8	S	M16x1.5	84306160805	28,48
1/4"	10	S	M18x1.5	84306181004	23,81
3/8"	10	S	M18x1.5	84306181006	32,14
5/16"	12	S	M20x1.5	84306201204	31,66
3/8"	12	S	M20x1.5	84306201206	27,53
1/2"	12	S	M20x1.5	84306201208	33,35
3/8"	14	S	M22x1.5	84306221406	37,68
3/8"	16	S	M24x1.5	84306241606	33,03
1/2"	16	S	M24x1.5	84306241608	31,35
3/8"	20	S	M30x2	84306302006	63,59
1/2"	20	S	M30x2	84306302008	55,33
5/8"	20	S	M30x2	84306302010	50,12
3/4"	20	S	M30x2	84306302012	58,23
3/4"	25	S	M36x2	84306362512	81,16
1"	25	S	M36x2	84306362516	98,78
3/4"	30	S	M42x2	84306423012	152,08
1"	30	S	M42x2	84306423016	119,94
1" 1/4	38	S	M52x2	84306523820	204,65

Standard series

Conexiones Standard
Standardserie
Embouts série standard

Metric female swivel without o'ring 24° cone

Hembras giratorias rectas rosca Métrica 24° sin junta tórica

Dichtkegel mit U-Mutter ohne O-Ring DIN 20078 DKL/DKS

Femelle Métrique cône 24° sans o'ring

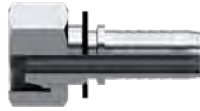

DN	TUBO PIPE	SERIE SERIES	ROSCA THREAD	Referencia Part n°	€
1/4"	8	L	M14x1.5	84814140804	11,45
5/16"	10	L	M16x1.5	84814161005	17,98
3/8"	12	L	M18x1.5	84814181206	16,11
1/2"	15	L	M22x1.5	84814221508	18,49
5/8"	18	L	M26x1.5	84814261810	25,51
3/4"	22	L	M30x2	84814302212	37,72
1"	28	L	M36x2	84814362816 <small>NEW</small>	55,22

Metric swivel female without o'ring 24° cone (90° Elbow)

Hembras giratorias 90° Métricas 24° sin junta tórica

Dichtkegel mit Ü-Mutter ohne O-Ring DIN 20078 90° Bogen DKL 90° /DKS 90°

Coude 90° femelle Métrique cône 24° sans o'ring



DN	TUBO PIPE	SERIE Serie	ROSCA THREAD	Referencia Part n°	€
1/4"	8	L	M14x1.5	84315140804	20,85
5/16"	10	L	M16x1.5	84315161005	27,61
3/8"	12	L	M18x1.5	84315181206	24,87
1/2"	15	L	M22x1.5	84315221508	31,05
5/8"	18	L	M26x1.5	84315261810	42,65
3/4"	22	L	M30x2	84315302212	58,25

Metric swivel female without o'ring 24° cone (45° Elbow)

Hembras giratorias 45° Métricas 24° sin junta tórica

Dichtkegel mit Ü-Mutter ohne O-Ring DIN 20078 45° Bogen DKL 45° /DKS 45° kon.

Coude 45° femelle Métrique cône 24° sans o'ring



DN	TUBO PIPE	SERIE SERIES	ROSCA THREAD	Referencia Part n°	€
1/4"	8	L	M14x1.5	84316140804	20,85
5/16"	10	L	M16x1.5	84316161005	27,61
3/8"	12	L	M18x1.5	84316181206	24,87
1/2"	15	L	M22x1.5	84316221508	31,05
5/8"	18	L	M26x1.5	84316261810	42,65
3/4"	22	L	M30x2	84316302212	58,25

- Sin junta tórica
- Especial mangueras PTFE
- Altas temperaturas
- Resistencia química

- Without o'ring
- PTFE Hose
- High temperature
- Chemist resistance



Standard series

Conexiones Standard
Standardserie
Embouts série standard

Metric standpipe for ISO 8434-1 / DIN2353 fittings

Espigas lisas rectas Métricas ISO 8434-1 / DIN2353

Metr. Stutzen BEL / BES gerade ISO 8434-1 /
DIN2353

Embout lisse droit Métrique ISO 8434-1 / DIN2353



DN	TUBO PIPE	Referencia Part n°	€
3.2 mm	6	841580601	10,80
1/8"	6	841580602	10,44
3/16"	6	841580603	10,21
1/4"	6	841580604	9,00
3/16"	8	841580803	10,75
1/4"	8	841580804	8,13
5/16"	8	841580805	10,92
3/8"	8	841580806	11,81
1/4"	10	841581004	10,26
5/16"	10	841581005	11,00
3/8"	10	841581006	9,90
1/4"	12	841581204	12,41
5/16"	12	841581205	12,69
3/8"	12	841581206	8,76
1/2"	12	841581208	12,17
3/8"	14	841581406	12,39
1/2"	14	841581408	17,24
3/8"	15	841581506	15,28
1/2"	15	841581508	12,98
1/2"	16	841581608	14,51
1/2"	18	841581808	19,64
5/8"	18	841581810	19,34
3/4"	18	841581812	28,07
1/2"	20	841582008	23,59
5/8"	20	841582010	22,12
3/4"	20	841582012	22,40
5/8"	22	841582210	23,37
3/4"	22	841582212	29,28
3/4"	25	841582512	29,10
1"	25	841582516	31,38
1"	28	841582816	34,52
1"	30	841583016	33,46
1"1/4	35	841583520	54,56
1"1/4	38	841583820	59,94
1"1/2	38	841583824	74,29
1"1/2	42	841584224	72,39

Fractional Straight standpipe

Espigas lisas rectas para tubo en pulgadas

Zölliger Stutzen gerade glatt

Embout lisse tube pouce



DN	TUBO PIPE	Referencia Part n°	€
1/4"	6.4	841590604	10,44
3/8"	9.5	841590906	12,88
3/8"	12.7	841591206	14,51
1/2"	12.7	841591208	13,83
5/8"	12.7	841591210	20,10
1/2"	15.8	841591508	18,87
5/8"	15.8	841591510	20,07
5/8"	19.05	841591910	32,14
3/4"	19.05	841591912	27,91
1"	25.4	841592516	39,21

Fractional HEX Straight standpipe TrAle® LOK

Espigas lisas rectas HEX para tubo en pulgadas
TrAle® LOK

Zölliger Stutzen gerade glatt HEX TrAle® LOK

Embout lisse tube HEX pouce TrAle® LOK



NEW

DN	TUBO PIPE	Referencia Part n°	€
1/4"	6.4	841690404	15,47
3/8"	9.5	841690606	18,03
1/2"	12.7	841690808	26,34
3/4"	19.05	841691212	33,32
1"	25.4	841691616	58,79

Metric standpipe ISO 8434-1 / DIN2353 fittings (90° Elbow)

Espigas lisas 90° Métricas ISO 8434-1 / DIN2353

Metr. Stutzen BEL / BES 90° ISO 8434-1 / DIN2353

Embout lisse coude 90° Métrique ISO 8434-1 /
DIN2353



DN	TUBO PIPE	Referencia Part n°	€
1/8"	6	842580602	31,79
3/16"	6	842580603	24,99
1/4"	6	842580604	18,55
3/16"	8	842580803	28,21
1/4"	8	842580804	17,48
5/16"	8	842580805	26,45
1/4"	10	842581004	19,27
5/16"	10	842581005	23,03
3/8"	10	842581006	25,10
1/4"	12	842581204	29,34
5/16"	12	842581205	24,35
3/8"	12	842581206	19,07
1/2"	12	842581208	33,76
3/8"	14	842581406	27,55
1/2"	14	842581408	36,51
3/8"	15	842581506	32,67
1/2"	15	842581508	28,68
1/2"	16	842581608	35,30
1/2"	18	842581808	36,12
5/8"	18	842581810	42,73
5/8"	20	842582010	47,61
3/4"	20	842582012	51,42
5/8"	22	842582210	65,07
3/4"	22	842582212	52,59
3/4"	25	842582512	58,60
1"	28	842582816	77,97
1"	30	842583016	84,53

Fractional standpipe (90° Elbow)

Espigas lisas 90° para tubo en pulgadas

Zölliger Stutzen glatt 90°

Embout lisse coude 90° tube pouce



DN	TUBO PIPE	Referencia Part n°	€
1/4"	6.4	842590604	29,24
3/8"	9.5	842590906	31,24
1/2"	12.7	842591208	38,96

Standard series

Conexiones Standard
Standardserie
Embouts série standard

Metric standpipe ISO 8434-1 / DIN2353 fittings (45° Elbow)

Espigas lisas 45° Métricas ISO 8434-1 / DIN2353

Metr. Stutzen BEL/BES 45° ISO 8434-1 / DIN2353

Embout lisse coude 45° ISO 8434-1 / DIN2353



DN	TUBO PIPE	Referencia Part n°	€
1/8"	6	843580602	31,79
3/16"	6	843580603	24,99
1/4"	6	843580604	18,55
3/16"	8	843580803	28,21
1/4"	8	843580804	17,48
5/16"	8	843580805*	26,45
1/4"	10	843581004	19,27
5/16"	10	843581005	23,03
3/8"	10	843581006	25,10
1/4"	12	843581204	29,34
5/16"	12	843581205	24,35
3/8"	12	843581206	19,07
1/2"	12	843581208	33,76
3/8"	14	843581406	27,55
1/2"	14	843581408	36,51
3/8"	15	843581506	32,67
1/2"	15	843581508	28,68
1/2"	16	843581608	35,30
1/2"	18	843581808	36,12
5/8"	18	843581810	42,73
5/8"	20	843582010	47,61
1/2"	20	843582012	51,42
5/8"	22	843582210	65,07
3/4"	22	843582212	52,59
3/4"	25	843582512	58,60
1"	28	843582816	77,97
1"	30	843583016	84,53

* Until end of stock / Hasta fin de existencias / Bis zum Ende des Lagerbestandes / Jusqu'à la fin du stock

Fractional Standpipe for inch tube (45° Elbow)

Espigas lisas 45° para tubo en pulgadas

Zölliger Stutzen glatt 45°

Embout lisse coude 45° tube pouce



DN	TUBO PIPE	Referencia Part n°	€
1/4"	6,4	843590604	29,24
3/8"	9,5	843590906	31,24
1/2"	12,7	843591208	38,96

Double crimp standpipe

Espigas de prensar dobles

Doppelnippel

Embout double jonction



DN	Referencia Part n°	€
1/4"	843000404	22,80
5/16"	843000505	23,81
3/8"	843000606	22,60
1/2"	843000808	28,16
3/4"	843001212	46,54
1"	843001616	55,11
1"1/4	843002020	111,66
1" 1/2	843002424	126,04
2"	843003232	266,98

Welding standpipes

Espigas soldables

Schweißstutzen

Embout lisse à souder



DN	Referencia Part n°	€
1/8"	840000200*	16,52
3/16"	840000300	16,59
1/4"	840000400	10,90
5/16"	840000500	14,59
3/8"	840000600	15,99
1/2"	840000800	16,97
5/8"	840001000	20,67
3/4"	840001200	21,46
1"	840001600	27,51
1"1/4	840002000	49,89
1"1/2	840002400	57,51
2"	840003200	101,29
2"1/2	840004000	208,21

* Until end of stock / Hasta fin de existencias / Bis zum Ende des Lagerbestandes / Jusqu'à la fin du stock

Standpipes for hidrowashing machines

Espigas para Hidrolavadoras

Stutzen für Waschgeräte

Embouts lisses pour hydrolavage



TUBO PIPE	ROSCA THREAD	Referencia Part n°	€
5/16"	M 22x1.5	8305005	19,88
3/8"	M 22x1.5	8305006	19,36

Hexagonal nuts for hydrowashing machines

Tuercas para terminales hidrolavadoras inox

Edelstahl-Muttern für Hochdruckreiniger

Écrous pour hidronettoyages



ROSCA THREAD	Referencia Part n°	€
M22x1.5	KZTHAP22	16,38

Standard series

Conexiones Standard
Standardserie
Embouts série standard

Banjo BSP

Orientables BSP

Ringaugen BSP RN-BSP

Banjo droit gaz BSP



DN	Ø	Referencia Part n°	€
1/4"	1/4"	841110404	34,34
1/4"	3/8"	841110604	48,66
5/16"	3/8"	841110605	55,65
3/8"	3/8"	841110606	46,60
1/2"	3/8"	841110608	64,80
3/8"	1/2"	841110806	66,95
1/2"	1/2"	841110808	71,56
3/4"	3/4"	841111212	104,34
1"	1"	841111616	324,54

BSP Bolt for banjo

Tornillo orientable simple BSP

Einfache Hohlschraube BSP für Ringauge

Vis creuse simple pour banjo gaz



ROSCA THREAD	Referencia Part n°	€
1/8" BSP	Z109002	*
1/4" BSP	Z109004	*
3/8" BSP	Z109006	*
1/2" BSP	Z109008	*
3/4" BSP	Z109012	*
1" BSP	Z109016	*

*See prices in p.176 (BSP ADAPTORS) / *Ver precios en p.176 (ADAPTADORES BSP) / *Vgl. Sie die Preise auf S.176 (BSP-Adapter) / *Prix à la p.176 (ADAPTEURS BSP)

Banjo Metric

Orientables Métricos

Ringaugen metr. nach DIN 7642 RN

Banjo droit Métrique



DN	Ø	Referencia Part n°	€
3/16"	M10x1	841161003	34,09
1/4"	M10x1	841161004	36,35
5/16"	M10x1	NEW 841161005	47,74
1/4"	M12x1.5	841161204	38,75
1/4"	M14x1.5	841161404	61,47
3/8"	M14x1.5	841161406	55,28
5/16"	M16x1.5	841161605	53,13
3/8"	M16x1.5	841161606	56,72
3/8"	M18x1.5	841161806	57,12
1/2"	M18x1.5	841161808	81,49
1/2"	M20x1.5	841162008	101,13
1/2"	M22x1.5	841162208	103,46
3/4"	M26x1.5	841162612	129,97

Metric bolt for banjo

Tornillo orientable simple Métrico

Einfache Hohlschraube metr. für Ringauge

Vis creuse simple for banjo Métrique



ROSCA THREAD	Referencia Part n°	€
M12X1.5	Z109212	*
M14X1.5	Z109214	*
M16X1.5	Z109216	*
M18X1.5	Z109218	*
M22X1.5	Z109222	*
M26X1.5	Z109226	*
M30X2	Z109230	*

*See prices in p.176 (BSP ADAPTORS) / *Ver precios en p.176 (ADAPTADORES BSP) / *Vgl. Sie die Preise auf S.176 (BSP-Adapter) / *Prix à la p.176 (ADAPTEURS BSP)

Standard series

Conexiones Standard
Standardserie
Embouts série standard

3000 PSI SAE Straight Flange / Code 61

Bridas rectas SAE 3000 PSI

Gerader Flansch SAE 3000 PSI

Bride SAE droite série 3000 PSI



DN	Ø	Referencia Part n°	€
1/2"	30,2	841820808	37,50
1/2"	38,1	841821208	62,61
5/8"	38,1	841821210	53,97
3/4"	38,1	841821212	52,83
3/4"	44,5	841821612	77,31
1"	44,5	841821616	67,47
1"	50,8	841822016	101,42
1"1/4	50,8	841822020	93,08
1"1/4	60,3	841822420	156,83
1"1/2	60,3	841822424	120,11
1"1/2	71,4	841823224	245,39
2"	71,4	841823232	210,78
2" 1/2	84,1	841824040	379,28
3"	101,6	841824848	615,84

3000 PSI SAE Flange (90° Elbow) / Code 61

Bridas 90° SAE 3000 PSI

Flansch 90° SAE 3000 PSI

Bride SAE coude 90° série 3000 PSI



DN	Ø	Referencia Part n°	€
1/2"	30,2	841830808	55,69
1/2"	38,1	841831208	72,71
5/8"	38,1	841831210	85,09
3/4"	38,1	841831212	78,28
3/4"	44,5	841831612	132,32
1"	44,5	841831616	102,57
1"	50,8	841832016	159,16
1"1/4	50,8	841832020	169,12
1"1/4	60,3	841832420	233,95
1"1/2	60,3	841832424	217,53
1"1/2	71,4	841833224	352,08
2"	71,4	841833232	369,92

3000 PSI SAE Flange (45° Elbow) / Code 61

Bridas 45° SAE 3000 PSI

Flansch 45° SAE 3000 PSI

Bride SAE coude 45° série 3000 PSI



DN	Ø	Referencia Part n°	€
1/2"	30,2	841840808	55,69
1/2"	38,1	841841208	72,71
5/8"	38,1	841841210	85,09
3/4"	38,1	841841212	78,28
3/4"	44,5	841841612	132,32
1"	44,5	841841616	102,57
1"	50,8	841842016	159,16
1"1/4	50,8	841842020	169,12
1"1/4	60,3	841842420	233,95
1"1/2	60,3	841842424	217,53
1"1/2	71,4	841843224	352,08
2"	71,4	841843232	369,92

6000 PSI SAE Straight Flange / Code 62

Bridas rectas SAE 6000 PSI

Gerader Flansch SAE 6000 PSI

Bride SAE droite série 6000 PSI



DN	Ø	Referencia Part n°	€
1/2"	31,8	842820808	44,09
1/2"	41,3	842821208	70,56
5/8"	41,3	842821210	75,79
3/4"	41,3	842821212	60,26
3/4"	47,6	842821612	83,52
1"	47,6	842821616	77,77
1"	54	842822016	120,22
1"1/4	54	842822020	108,67
1"1/4	63,5	842822420	166,84
1"1/2	63,5	842822424	177,01
1"1/2	79,4	842823224	321,10
2"	79,4	842823232	332,58

6000 PSI SAE Flange (90° Elbow) / Code 62

Bridas 90° SAE 6000 PSI

Flansch 90° SAE 6000 PSI

Bride SAE coude 90° série 6000 PSI



DN	Ø	Referencia Part n°	€
1/2"	31,8	842830808	58,99
1/2"	41,3	842831208	93,22
5/8"	41,3	842831210	101,23
3/4"	41,3	842831212	91,75
3/4"	47,6	842831612	123,36
1"	47,6	842831616	123,56
1"	54	842832016	164,13
1"1/4	54	842832020	176,09
1"1/4	63,5	842832420	300,42
1"1/2	63,5	842832424	306,71
1"1/2	79,4	842833224	405,14
2"	79,4	842833232	439,22

6000 PSI SAE Flange (45° Elbow) / Code 62

Bridas 45° SAE 6000 PSI

Flansch 45° SAE 6000 PSI

Bride SAE coude 45° série 6000 PSI



DN	Ø	Referencia Part n°	€
1/2"	31,8	842840808	58,99
1/2"	41,3	842841208	93,22
5/8"	41,3	842841210	101,23
3/4"	41,3	842841212	91,75
3/4"	47,6	842841612	123,36
1"	47,6	842841616	123,56
1"	54	842842016	164,13
1"1/4	54	842842020	176,09
1"1/4	63,5	842842420	300,42
1"1/2	63,5	842842424	306,71
1"1/2	79,4	842843224	405,14
2"	79,4	842843232	439,22

Standard series

Conexiones Standard
Standardserie
Embouts série standard

SAE Split flange

Brida partida pasante

Durchgehender Halbflansch

Demi-bride de fixation



SERIE SERIES	Ø INT. Ø INNER	TAMAÑO SIZE	Referencia Part n°	€
3000 PSI	30.2	1/2"	ZBBP308302	13,86
3000 PSI	38.1	3/4"	ZBBP312381	17,89
3000 PSI	44.5	1"	ZBBP316445	21,30
3000 PSI	50.8	1"1/4	ZBBP320508	30,74
3000 PSI	60.3	1"1/2	ZBBP324603	40,38
3000 PSI	71.4	2"	ZBBP332714	48,78
3000 PSI	84.1	2" 1/2	ZBBP340841	98,57
3000 PSI	102.4	3"	ZBBP3481024	106,02
3000 PSI	127	4"	ZBBP364127	201,88
6000 PSI	31.8	1/2"	ZBBP608318	18,32
6000 PSI	41.3	3/4"	ZBBP612413	26,79
6000 PSI	47.6	1"	ZBBP616476	40,88
6000 PSI	54	1"1/4	ZBBP620540	55,66
6000 PSI	63.5	1"1/2	ZBBP624635	86,01
6000 PSI	79.4	2"	ZBBP632794	149,34

€/pair / €/par / €/para / €/paire

SAE counter-flange

Contrabrida roscada

Gewindegegenflansch

Contre-bride passage total



SERIE SERIES	Ø INT. Ø INNER	TAMAÑO SIZE	Referencia Part n°	€
3000 PSI	30,2	1/2"	ZBCE308302	*
3000 PSI	38,1	3/4"	ZBCE312381	*
3000 PSI	44,5	1"	ZBCE316445	*
3000 PSI	50,8	1"1/4	ZBCE320508	*
3000 PSI	60,3	1"1/2	ZBCE324603	*
3000 PSI	71,4	2"	ZBCE332714	*
6000 PSI	31,8	1/2"	ZBCE608318	*
6000 PSI	41,3	3/4"	ZBCE612413	*
6000 PSI	47,6	1"	ZBCE616476	*
6000 PSI	54	1"1/4	ZBCE620540	*
6000 PSI	63,5	1"1/2	ZBCE624635	*
6000 PSI	79,4	2"	ZBCE632794	*

Seals for 3000/6000 PSI flange

Juntas para bridas SAE 3000/6000 PSI

Dichtungen 3000/6000 PSI-Flansch

Joints pour bride série 3000/6000



TAMAÑO SIZE	Ø INT. Ø INNER	Ø EXT. Ø OUTER	Referencia Part n°	€
1/2"	17.02	25.40	JBR08	*
3/4"	23.36	31.72	JBR12	*
1"	31.24	39.62	JBR16	*
1"1/4	36.07	44.45	JBR20	*
1"1/2	45.34	53.98	JBR24	*
2"	54.86	63.50	JBR32	*

*See prices in Hydraulic and Pneumatic Connectors' Catalogue / *Ver precios en Conducciones Hidráulicas y Neumáticas / *Vgl. Sie die Preise in der Preisliste Hydraulische und Pneumatische Verbindungen. / *Voor prix dans le Catalogue Connectique Hydraulique et Pneumatique

O-rings for 3000/6000 PSI flange

Juntas tóricas para bridas SAE 3000/6000 PSI

O-Ringe für 3000/6000 PSI-Flansch

O-rings pour bride série 3000/6000 PSI



TAMAÑO SIZE	Ø INT. Ø INNER	Referencia Part n°	€
1/2"	18.64	18.64X3.53	*
3/4"	24.99	24.99X3.53	*
1"	32.92	32.92X3.53	*
1"1/4	37.70	37.70X3.53	*
1"1/2	47.22	47.22X3.53	*
2"	56.74	56.74X3.53	*

*See prices in Hydraulic and Pneumatic Connectors' Catalogue / *Ver precios en Conducciones Hidráulicas y Neumáticas / *Vgl. Sie die Preise in der Preisliste Hydraulische und Pneumatische Verbindungen. / *Voor prix dans le Catalogue Connectique Hydraulique et Pneumatique

Screws for SAE flanges

Tornillos para bridas SAE

Schrauben für SAE-Flansche

Vis pour brides SAE



ROSCA THREAD	TAMAÑO SIZE	€
M8X30	3000-6000 PSI 1/2"	ZTB8X30 *
M10X35	3000 PSI 3/4"-1"	ZTB10X35 *
M10X40	3000 PSI 1" 1/4 - 6000 PSI 3/4"	ZTB10X40 *
M12X45	3000 PSI 1"1/2-2"-2"1/2-6000 PSI 1"	ZTB12X45 *
M14X45	6000 PSI 1"1/4	ZTB14X45 *
M16X50	3000 PSI 3"-3"1/2"-4"- 6000 PSI 1" 1/2	ZTB16X50 *
M20X70	6000 PSI 2"	ZTB20X70 *

*See prices p.154 / *Ver precios en p.154 / *Vgl. Sie die Preise auf S.154 / *Voor prix p.154

Standard series

Conexiones Standard
Standardserie
Embouts série standard

Double hexagonal ORFS Swivel female straight

Hembras giratorias rectas ORFS doble hexagonal

Dichtkopf mit ORFS Ü-Mutter doppelt 6 kt

Femelle droite ORFS double hexagonal



DN	ROSCA THREAD	Referencia Part n°	€
1/4"	9/16"-18h	849010904	27,55
1/4"	11/16"-16h	849011104	37,74
5/16"	11/16"-16h	849011105	35,26
3/8"	11/16"-16h	849011106	30,77
3/8"	13/16"-16h	849011306	39,46
1/2"	13/16"-16h	849011308	34,86
1/2"	1"-14h	849011608	68,93
5/8"	1"-14h	849011610	53,18
1/2"	1"3/16-12h	849011908	80,03
5/8"	1"3/16-12h	849011910	74,48
3/4"	1"3/16-12h	849011912	55,84
3/4"	1"7/16-12h	849012312	89,76
1"	1"7/16-12h	849012316	95,61
1"1/4"	1"11/16-12h	849012720	146,74
1"1/2"	2"-12h	849013224	170,74
2"	2"-12h	849013232	304,41

ORFS Male

Machos ORFS

Außengewinde ORFS

Mâle ORFS



DN	ROSCA THREAD	Referencia Part n°	€
1/4"	9/16"-18h	849120904	33,33
5/16"	11/16"-16h	849121105	32,24
3/8"	11/16"-16h	849121106	31,53
1/2"	13/16"-16h	849121308	39,42
5/8"	1"-14h	849121610	58,13
3/4"	1"3/16-12h	849121912	72,55
1"	1"7/16-12h	849122316	99,52
1"1/4"	1"11/16-12h	849122720	137,64
1"1/2"	2"-12h	849123224	204,60

ORFS Swivel female (90° Elbow)

Hembras giratorias 90° ORFS

Dichtkopf 90° ORFS - LOR

Coude 90° femelle ORFS



DN	ROSCA THREAD	Referencia Part n°	€
1/4"	9/16"-18h	849070904	51,93
1/4"	11/16"-16h	849071104	65,74
5/16"	11/16"-16h	849071105	64,25
3/8"	11/16"-16h	849071106	62,26
3/8"	13/16"-16h	849071306	68,84
1/2"	13/16"-16h	849071308	72,23
1/2"	1"-14h	849071608	103,59
5/8"	1"-14h	849071610	91,66
5/8"	1"3/16-12h	849071910	132,63
3/4"	1"3/16-12h	849071912	115,33
3/4"	1"7/16-12h	849072312	171,87
1"	1"7/16-12h	849072316	167,45
1"1/4"	1"11/16-12h	849072720	235,28
1"1/2"	2"-12h	849073224	677,12

ORFS Swivel female (45° Elbow)

Hembras giratorias 45° ORFS

Dichtkopf 45° ORFS - LOR

Coude 45° femelle ORFS



DN	ROSCA THREAD	Referencia Part n°	€
1/4"	9/16"-18h	849080904	51,93
1/4"	11/16"-16h	849081104	65,74
5/16"	11/16"-16h	849081105	64,25
3/8"	11/16"-16h	849081106	62,26
3/8"	13/16"-16h	849081306	68,84
1/2"	13/16"-16h	849081308	72,23
1/2"	1"-14h	849081608	103,59
5/8"	1"-14h	849081610	91,66
5/8"	1"3/16-12h	849081910	132,63
3/4"	1"3/16-12h	849081912	115,33
3/4"	1"7/16-12h	849082312	171,87
1"	1"7/16-12h	849082316	167,45
1"1/4"	1"11/16-12h	849082720	235,28
1"1/2"	2"-12h	849083224	677,12

Macho O'Ring Boss

Macho O'Ring Boss

Außengewinde O'Ring Boss

Mâle O'Ring Boss



DN	ROSCA THREAD	Referencia Part n°	€
1/4"	7/16"-20h UNF	847120604	19,43
3/8"	9/16"-18h UNF	847121006	20,48
1/2"	3/4"-16h UNF	847121208	20,61
5/8"	7/8"-14h UNF	847121610	25,64
3/4"	1"1/16-12h UN	847122012	47,16
1"	1"5/16-12h UN	847122516	77,48

Fittings BW+ Series R13/R15 No Skive

Conexiones Serie BW+ R13/R15 No Pelar
 Armaturen Serie BW+ R13/R15 ohne Schälung
 Embouts R13/R15 Série BW+ Sans denuder

Ferrules R13/R15 for fittings BW/BW+ series

Casquillos R13/R15 para serie BW/BW+

Pressfassungen R13/R15 für Armaturen Serie BW/BW+

Jupes R13/R15 pour embouts série BW/BW+



DN	Referencia Part n°	€
1"1/4	ZAC690102000	97,06
1"1/2	ZAC690102400	113,52
2"	ZAC690103200	191,31

BSP Swivel female 60° cone double hexagonal with o'ring

Hembras gir. rectas BSP cono 60° doble hexagonal c/j

Dichtkopf mit BSP Ü-Mutter 60° doppelt 6 kt mit O-Ring

Femelle tournante gaz cyl BSP 60° double hexagonale avec o'ring



DN	ROSCA THREAD	Referencia Part n°	€
1"1/4	1"1/4 BSP	Z664102020	169,19
1"1/2	1"1/2 BSP	Z664102424	224,78
2"	2" BSP	Z664103232	458,61

Until end of stock / Hasta fin de existencias / Bis zum Ende des Lagerbestandes / Jusqu'à la fin du stock

BSP Swivel female 60° cone with o'ring (90° Elbow)

Hembras giratorias 90° BSP cono 60° con junta

Dichtkopf mit BSP Ü-Mutter 60° 90° mit O-Ring

Coude 90° femelle tournante gaz cyl BSP 60° avec joint



DN	ROSCA THREAD	Referencia Part n°	€
1"1/4	1"1/4 BSP	Z661172020	145,20

Until end of stock / Hasta fin de existencias / Bis zum Ende des Lagerbestandes / Jusqu'à la fin du stock

BSP Swivel female 60° cone with o'ring (45° Elbow)

Hembras giratorias 45° BSP cono 60° con junta

Dichtkopf mit BSP 60° Ü-Mutter kon. 45° mit O-Ring

Hembras giratorias 45° BSP cono 60° avec o'ring



DN	ROSCA THREAD	Referencia Part n°	€
1"1/4	1"1/4 BSP	Z661182020	145,20

Until end of stock / Hasta fin de existencias / Bis zum Ende des Lagerbestandes / Jusqu'à la fin du stock

BSP Male 60° cone

Machos cilíndricos BSP 60°

Außengewinde zyl. BSP 60°

Mâle gaz cylindrique BSP 60°



DN	ROSCA THREAD	Referencia Part n°	€
1"1/4	1"1/4 BSP	Z661122020	101,02
1"1/2	1"1/2 BSP	Z661122424	135,23
2"	2" BSP	Z661123232	254,15

Double hexagonal BSP Swivel female cone 60° with o'ring wire nut



Hembras gir rectas BSP (60°) doble hex c/J tca eng.

Dichtkopf mit BSP 60° kon. doppelt 6 kt mit O-Ring Muffenmutter

Femelle BSP cône 60° double hexagonal avec joint torique écrou à douille



DN	ROSCA THREAD	Referencia Part n°	€
1"1/4	1"1/4 BSP	Z665102020	122,93
1"1/2	1"1/2 BSP	Z665102424	194,58
2"	2" BSP	Z665103232	321,64

BSP 60° cone Swivel female (90° Elbow) with o'ring wire nut



Hembras gir 90° BSP (60°) c/j tca engargolada

Dichtkopf mit BSP 60° Ü-Mutter DKR 90° kon. mit O-Ring Muffenmutter

Coude 90° femelle gaz cylindrique BSP 60° avec joint torique écrou à jonc



DN	ROSCA THREAD	Referencia Part n°	€
1"1/4 BSP	1"1/4 BSP	Z665172020	161,78
1"1/2 BSP	1"1/2 BSP	Z665172424	222,33
2" BSP	2" BSP	Z665173232	397,39

BSP 60° cone Swivel female (45° Elbow) with o'ring wire nut



Hembras gir 45° BSP (60°) c/j tca engargolada

Dichtkopf mit BSP 60° Ü-Mutter DKR 45° kon. mit O-Ring Muffenmutter

Coude 45° femelle gaz cylindrique BSP 60° avec joint torique écrou à jonc



DN	ROSCA THREAD	Referencia Part n°	€
1"1/4 BSP	1"1/4	Z665182020	161,78
1"1/2 BSP	1"1/2	Z665182424	222,33
2" BSP	2"	Z665183232	397,39

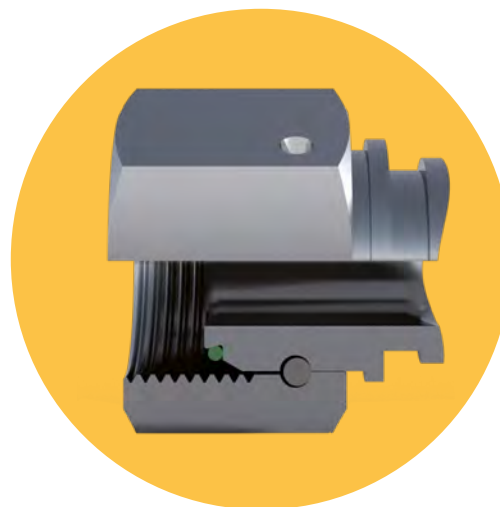

Fittings BW+ Series R13/R15 No Skive

Conexiones Serie BW+ R13/R15 No Pelar
Armaturen Serie BW+ R13/R15 ohne Schälung
Embouts R13/R15 Série BW+ Sans denuder

Double hexagonal NPSM female 60° cone with o'ring

Hembras gir rectas NPSM (60°) doble hexagonal con junta

Dichtkopf mit NPSM Ü-Mutter 60° kon. doppelt 6 kt mit O-Ring

Femelle NPSM cône 60° double hexagonal avec joint torique



DN	ROSCA THREAD	Referencia Part n°	€
1"1/4	1"1/4 NPSM	Z664612020	177,65
1"1/2	1"1/2 NPSM	Z664612424	236,02
2"	2" NPSM	Z664613232	387,64

NPT Male pipe straight

Machos cónicos NPT

Außengewinde NPT

Mâle conique NPT



DN	ROSCA THREAD	Referencia Part n°	€
1"1/4	1"1/4 NPT	Z661612020	94,17
1"1/2	1"1/2 NPT	Z661612424	132,13
2"	2" NPT	Z661613232	258,52

Double Hexagonal JIC 37° Swivel female

Hembras giratorias rectas JIC 37° doble hexagonal

Dichtkonus mit Ü-Mutter JIC 37° doppelt 6 kt

Femelle JIC 37° double hexagonal



DN	ROSCA THREAD	Referencia Part n°	€
1"1/4	1"5/8 12h UN	Z662422620	187,20
1"1/2	1"7/8 12h UN	Z662423024	281,28
2"	2"1/2 12h UN	Z662424032	418,42

JIC 37° Swivel female (90° Elbow)

Hembras giratorias 90° JIC 37°

Dichtkonus mit Ü-Mutter 37° JIC 90°

Coude 90° femelle JIC 37°



DN	ROSCA THREAD	Referencia Part n°	€
1"1/4	1"5/8 12h UN	Z661382620	144,99
1"1/2	1"7/8 12h UN	Z661383024	188,90
2"	2"1/2 12h UN	Z661384032	385,29

JIC 37° Swivel female (45° Elbow)

Hembras giratorias 45° JIC 37°

Dichtkonus mit Ü-Mutter 37° JIC 45°

Coude 45° femelle JIC 37°



DN	ROSCA THREAD	Referencia Part n°	€
1"1/4	1"5/8 12h UN	Z661392620	143,76
1"1/2	1"7/8 12h UN	Z661393024	188,90
2"	2"1/2 12h UN	Z661394032	385,29

JIC 37° male with o'ring

Machos JIC 37° con junta

Außengewinde JIC 37° mit O-Ring

Mâle JIC 37° avec joint torique



DN	ROSCA THREAD	Referencia Part n°	€
1"1/4	1"5/8 12h UNF	Z661412620	97,31
1"1/2	1"7/8 12h UNF	Z661413024	104,99
2"	2"1/2 12h UNF	Z661414032	228,69

Fittings BW+ Series R13/R15 No Skive

Conexiones Serie BW+ R13/R15 No Pelar
Armaturen Serie BW+ R13/R15 ohne Schälung
Embouts R13/R15 Série BW+ Sans denuder

ORFS Swivel female straight

Hembras giratorias rectas ORFS doble hexagonal

Dichtkopf mit Ü-Mutter ORFS doppelt 6 kt

Femelle droite ORFS



DN	ROSCA THREAD	Referencia Part n°	€
1" 1/4	1"11/16-12h	Z669012720	151,88
1" 1/2	2"-12h	Z669013224	201,43

ORFS Swivel female (90° Elbow)

Hembras giratorias 90° ORFS asiento plano

Dichtkopf mit Ü-Mutter ORFS 90° flachdichtend

Coude 90° femelle ORFS



DN	ROSCA THREAD	Referencia Part n°	€
1" 1/4	1"11/16-12h	Z669072720	357,76
1" 1/2	2"-12h	Z669073224	1.041,45

ORFS Swivel female (45° Elbow)

Hembras giratorias 45° ORFS asiento plano

Dichtkopf mit Ü-Mutter 45° ORFS flachdichtend

Coude 45° femelle ORFS



DN	ROSCA THREAD	Referencia Part n°	€
1" 1/4	1"11/16-12h	Z669082720*	357,76
1" 1/2	2"-12h	Z669083224	1.041,45

*

ORFS Male

Machos ORFS

Außengewinde ORFS

Mâle ORFS



DN	ROSCA THREAD	Referencia Part n°	€
1"1/4	1"11/16-12h	Z669122720	267,40
1"1/2	2"-12h	Z669123224	393,54

Metric swivel female 24° seat with o'ring

Hembras giratorias Métricas cono 24° con junta tórica

Dichtkopf mit Ü-Mutter kon. 24° DKO

Femelle Métrique 24° avec o'ring



DN	TUBO PIPE	SERIE SERIES	ROSCA THREAD	Referencia Part n°	€
1"1/4	38	S	M52X2	Z66204523820	106,38
1"1/2	38	S	M52X2	Z66204523824	137,56

Metric swivel female 24° seat with o'ring (90° Elbow)

Hembras giratorias 90° Métricas cono 24° con junta tórica

Dichtkegel mit Ü-Mutter kon. 24° DKO 90°

Coude 90° femelle Métrique 24° avec o'ring



DN	TUBO PIPE	SERIE SERIES	ROSCA THREAD	Referencia Part n°	€
1"1/4	38	S	M52X2	Z66205523820	179,17

Metric swivel female 24° seat with o'ring (45° Elbow)

Hembras giratorias 45° Métricas cono 24° con junta tórica

Dichtkegel mit Ü-Mutter kon. 24° DKO 45°

Coude 45° femelle Métrique 24° avec o'ring



DN	TUBO PIPE	SERIE SERIES	ROSCA THREAD	Referencia Part n°	€
1"1/4	38	S	M52X2	Z66206523820	179,17

Metric male stud 24° cone

Machos fijos Métricos cono 24°

Außengewinde metr. kon. 24°

Mâle Métrique cône 24°

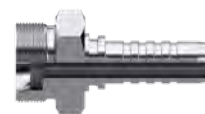

DN	TUBO PIPE	SERIE SERIES	ROSCA THREAD	Referencia Part n°	€
1"1/4	38	S	M52x2	Z66203523820	135,30

Fittings BW+ Series R13/R15 No Skive

Conexiones Serie BW+ R13/R15 No Pelar
 Armaturen Serie BW+ R13/R15 ohne Schälung
 Embouts R13/R15 Série BW+ Sans denuder

6000 PSI SAE Straight Flange / Code 62

Bridas recta SAE 6000 PSI

Gerader Flansch SAE 6000 PSI

Bride SAE droite série 6000 PSI



DN	∅	Referencia Part n°	€
1"1/4	54	Z662822020	132,59
1"1/4	63.5	Z662822420	166,37
1"1/2	63.5	Z662822424	194,31
2"	54	Z662822032	300,68
2"	79.4	Z662823232	277,20

6000 PSI SAE Flange (90° Elbow) / Code 62

Bridas a 90° SAE 6000 PSI

Flansch 90° SAE 6000 PSI

Bride SAE coude 90° série 6000 PSI



DN	∅	Referencia Part n°	€
1"1/4	54	Z662832020	176,78
1"1/4	63.5	NEW Z662832420	361,00
1"1/2	63.5	Z662832424	266,47
2"	79.4	Z662833232	406,52

6000 PSI SAE Flange (45° Elbow) / Code 62

Bridas a 45° SAE 6000 PSI

Flansch 45° SAE 6000 PSI

Bride SAE coude 45° série 6000 PSI



DN	∅	Referencia Part n°	€
1"1/4	54	Z662842020	176,78
1"1/2	63.5	Z662842424	266,47
2"	79.4	Z662843232	406,52

Interlock series

Conexiones Interlock

Armaturen Interlock

Embouts Interlock

Ferrules DIN 20023 - 4SH Interlock

Casquillos Interlock 4SH

Pressfassungen 4 SH DIN 20023/EN 856-4SH

Jupes à sertir DIN 20023 - 4SH Interlock



DN	MANGUERA HOSE	Referencia Part n°	€
3/4"	4SH / R13 / R15	ZA610101200	32,72
1"	4SH / R13 / R15	ZA610101600	50,93
1"1/4	4SH	ZA610102000	78,63
1"1/2	4SH	ZA610102400	102,69
2"	4SH	ZA610103200	155,00

Ferrules SAE 100 R13/R15 Interlock

Casquillos Interlock R13/R15

Pressfassungen SAE 100 R13/R15

Jupes à sertir R13/R15 Interlock



DN	Referencia Part n°	€
1" 1/4	Z610102000	92,30
1"1/2	Z610102400	125,30
2"	Z610103200	169,55

3/4" and 1" are the same ferrules as in 4SH / Para 3/4" y 1" son los mismos casquillos que en 4SH / Für 3/4" und 1" werden die gleichen Presshülsen wie für 4SH verwendet / 3/4" et 1" sont les mêmes jupes que pour 4SH

BSP 60° cone Swivel female Interlock (90° Elbow) with o'ring

Hembras giratoria 90° BSP cono 60° con junta

Dichtkopf mit BSP 60° Ü-Mutter Interlock DKR 90°
kon. mit O-Ring

Coude 90° femelle gaz cylindrique BSP 60°
Interlock avec joint torique



DN	ROSCA THREAD	Referencia Part n°	€
1"1/4	1"1/4 BSP	Z641072020	142,35
2"	2" BSP	Z641073232	432,39

Until end of stock / Hasta fin de existencias / Bis zum Ende des Lagerbestandes / Jusqu'à la fin du stock

BSP 60° cone Swivel female Interlock (45° Elbow) with o'ring

Hembras giratoria 45° BSP cono 60° con junta

Dichtkopf mit BSP 60° Ü-Mutter Interlock DKR 45°
kon. mit O-Ring

Coude 45° femelle gaz cylindrique BSP 60°
Interlock avec joint torique



DN	ROSCA THREAD	Referencia Part n°	€
3/4"	3/4" BSP	Z641081212	60,50
2"	2" BSP	Z641083232	432,39

Until end of stock / Hasta fin de existencias / Bis zum Ende des Lagerbestandes / Jusqu'à la fin du stock

BSP 60° Male cone

Machos cilíndricos BSP cono 60°

BSP Einschraubzapfen zyl. DIN 3852 Form A AFR

Mâle gaz cylindrique BSP 60° Interlock



DN	ROSCA THREAD	Referencia Part n°	€
3/4"	3/4" BSP	Z641121212	39,38
1"	1" BSP	Z641121616	72,86
1"1/4	1"1/4 BSP	Z641122020	108,54
1"1/2	1"1/2 BSP	Z641122424	146,29
2"	2" BSP	Z641123232	238,76

NPT Male pipe straight Interlock

Machos cónicos NPT

Außengewinde NPT AGN Interlock

Mâle conique NPT Interlock



DN	ROSCA THREAD	Referencia Part n°	€
3/4"	3/4" NPT	Z641611212	43,71
1"	1" NPT	Z641611616	60,07
1"1/4	1"1/4 NPT	Z641612020	122,75
1"1/2	1"1/2 NPT	Z641612424	153,37
2"	2" NPT	Z641613232	243,74

Interlock series

Conexiones Interlock
Armaturen Interlock
Embouts Interlock

BSP 60° cone Swivel female Interlock with o'ring wire nut

Hembras gir rectas BSP (60°) con junta (tca engargolada)

Dichtkopf mit BSP Ü-Mutter Interlock DKR mit O-Ring Muffenmutter

Femelle droite gaz cylindrique BSP 60° Interlock avec joint torique écrou à jonc



DN	ROSCA THREAD	Referencia Part n°	€
3/4"	3/4" BSP	Z645001212	39,87
1"	1" BSP	Z645001616	55,22
1"1/4	1"1/4 BSP	Z645002020	80,50
1"1/2	1"1/2 BSP	Z645002424	96,94
2"	2" BSP	Z645003232	167,28

BSP 60° cone Swivel female Interlock (90° Elbow) with o'ring wire nut

Hembras gir 90° BSP (60°) con junta (tca engargolada)

Dichtkopf mit BSP 60° Ü-Mutter Interlock DKR 90° kon. mit O-Ring Muffenmutter

Coude 90° femelle gaz cylindrique BSP 60° Interlock avec joint torique écrou à jonc



DN	ROSCA THREAD	Referencia Part n°	€
3/4"	3/4" BSP	Z645071212	62,55
1"	1" BSP	Z645071616	101,17
1"1/4	1"1/4 BSP	Z645072020	144,77
1"1/2	1"1/2 BSP	Z645072424	234,52
2"	2" BSP	Z645073232	449,01

BSP 60° cone Swivel female Interlock (45° Elbow) with o'ring wire nut

Hembras gir 45° BSP (60°) con junta (tca engargolada)

Dichtkopf mit BSP 60° Ü-Mutter Interlock DKR 45° kon. mit O-Ring Muffenmutter

Coude 45° femelle gaz cylindrique BSP 60° Interlock avec joint torique écrou à jonc



DN	ROSCA THREAD	Referencia Part n°	€
3/4"	3/4" BSP	Z645081212	62,55
1"	1" BSP	Z645081616	101,17
1"1/4	1"1/4 BSP	Z645082020	144,77
1"1/2	1"1/2 BSP	Z645082424	234,52
2"	2" BSP	Z645083232	449,01

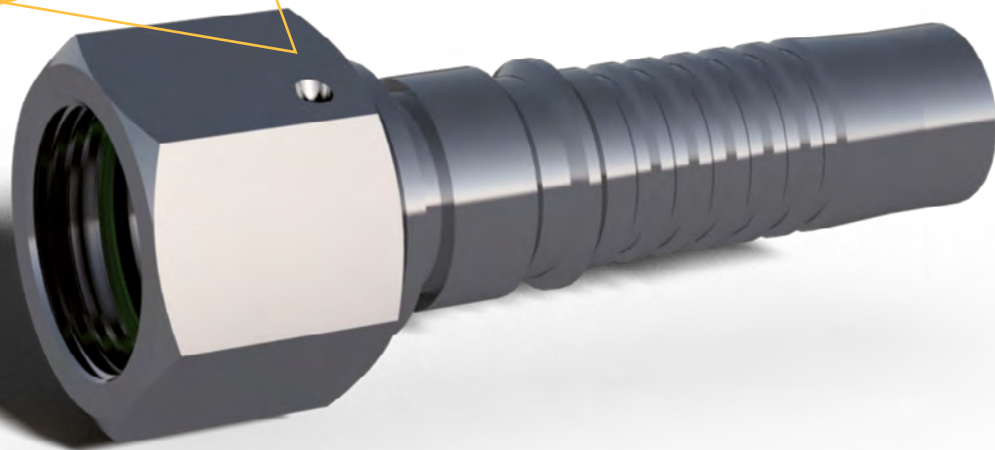

Interlock series

Conexiones Interlock

Armaturen Interlock

Embouts Interlock

Double hexagonal JIC 37° Swivel female

Hembras giratorias JIC 37° doble hexagonal Interlock

Dichtkonus einteilig Ü-Mutter 37° JIC doppelt 6 kt Interlock

Femelle JIC 37° double hexagonal



DN	ROSCA THREAD	Referencia Part n°	€
3/4"	1"1/16 12h UN	Z642421712	47,49
1"	1"5/16 12h UN	Z642422116	73,38
1"1/4	1"5/8 12h UN	Z642422620	173,25
1"1/2	1"7/8 12h UN	Z642423024	264,67
2"	2"1/2 12h UN	Z642424032	389,80

JIC 37° male Interlock

Machos JIC 37° Interlock

Außengewinde JIC 37°

Mâle JIC 37° Interlock



DN	ROSCA THREAD	Referencia Part n°	€
3/4"	1"1/16 12h UN	Z641401712	60,14
1"	1"5/16 12h UN	Z641402116	102,56
1"1/4	1"5/8 12h UN	Z641402620	113,50
1"1/2	1"7/8 12h UN	Z641403024	120,31
2"	2"1/2 12h UN	Z641404032	251,07

JIC 37° Swivel female Interlock

Hembras giratorias rectas JIC 37° Interlock

Dichtkonus mit Ü-Mutter JIC 37° Interlock

Femelle tourn.droite JIC 37° Interlock



DN	ROSCA THREAD	Referencia Part n°	€
3/4"	1"1/16 12h UN	Z641421712	42,15
1"	1"5/16 12h UN	Z641422116	49,82
1"1/4	1"5/8 12h UN	Z641422620	83,57
1"1/4	1"7/8 12h UN	Z641423020	111,10
1"1/2	1"7/8 12h UN	Z641423024	122,88
2"	2"1/2 12h UN	Z641424032	211,92

JIC 37° Swivel female Interlock (90° Elbow)

Hembras giratorias 90° JIC 37° Interlock

JIC 37° Dichtkonus 90° DKJ 90° interlock

Coude 90° femelle tournante JIC 37° Interlock



DN	ROSCA THREAD	Referencia Part n°	€
3/4"	1"1/16 12h UN	Z641381712	60,29
1"	1"5/16 12h UN	Z641382116	106,22
1"1/4	1"5/8 12h UN	Z641382620	147,05
1"1/2	1"7/8 12h UN	Z641383024	237,91
2"	2"1/2 12h UN	Z641384032	469,65

JIC 37° Swivel female Interlock (45° Elbow)

Hembras giratorias 45° JIC 37° Interlock

Dichtkonus JIC 37° 45° DKJ 45° Interlock

Coude 45° femelle tournante JIC 37° Interlock



DN	ROSCA THREAD	Referencia Part n°	€
3/4"	1"1/16 12h UN	Z641391712	60,29
1"	1"5/16 12h UN	Z641392116	106,05
1"1/4	1"5/8 12h UN	Z641392620	147,05
1"1/2	1"7/8 12h UN	Z641393024	237,91
2"	2"1/2 12h UN	Z641394032	469,65



Bajo Consulta
On Request

Interlock series

Conexiones Interlock

Armaturen Interlock

Embouts Interlock

Metric swivel female 24° seat serie S Interlock with o'ring

Hembras gir rectas Métricas 24° Interlock con junta tórica

Dichtkegel mit Ü-Mutter O-Ring DIN 20078 Interlock

Femelle droite Métrique 24° Interlock avec o'ring

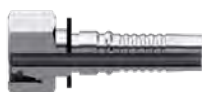

DN	TUBO PIPE	SERIE SERIES	ROSCA THREAD	Referencia Part n°	€
3/4"	20	S	M30x2	Z64204302012	48,96
3/4"	25	S	M36x2	Z64204362512	64,45
1"	30	S	M42x2	Z64204423016	81,06
1"1/4	38	S	M52x2	Z64204523820	119,81
1"1/2	38	S	M52x2	Z64204523824	145,19

Metric swivel female 24° seat serie S Interlock with o'ring (90° Elbow)

Hembras 90° Métricas cono 24° Interlock con junta tórica

Dichtkegel mit Ü-Mutter O-Ring DIN 20078 90° Interlock

Coude 90° femelle Métrique 24° Interlock avec o'ring



DN	TUBO PIPE	SERIE SERIES	ROSCA THREAD	Referencia Part n°	€
3/4"	20	S	M30x2	Z64205302012	65,28
3/4"	25	S	M36x2	Z64205362512	105,10
1"	30	S	M42x2	Z64205423016	139,86
1"1/4	38	S	M52x2	Z64205523820	191,24
1"1/2	38	S	M52x2	Z64205523824	260,45

Metric swivel female 24° seat serie S Interlock with o'ring (45° Elbow)

Hembras 45° Métricas cono 24° Interlock con junta tórica

Dichtkegel mit Ü-Mutter O-Ring DIN 20078 45° Interlock

Coude 45° femelle Métrique 24° Interlock avec o'ring



DN	TUBO PIPE	SERIE SERIES	ROSCA THREAD	Referencia Part n°	€
3/4"	20	S	M30x2	Z64206302012	65,28
3/4"	25	S	M36x2	Z64206362512	105,10
1"	30	S	M42x2	Z64206423016	139,86
1"1/4	38	S	M52x2	Z64206523820	191,24

Metric male stud 24° cone serie S Interlock

Machos Métricos cono 24° Interlock

Gewindezapfen DIN 20078 Interlock

Mâle Métrique cône 24° Interlock



DN	TUBO PIPE	SERIE SERIES	ROSCA THREAD	Referencia Part n°	€
3/4"	20	S	M30x2	Z64203302012	51,44
3/4"	25	S	M36x2	Z64203362512	78,76
1"	30	S	M42x2	Z64203423016	111,97
1"1/4	38	S	M52x2	Z64203523820	142,38

Interlock ORFS Swivel female straight

Hembras giratorias rectas ORFS Interlock

Dichtkopf mit ORFS Ü-Mutter - Interlock

Femelle droite ORFS Interlock



DN	ROSCA THREAD	Referencia Part n°	€
3/4"	1"3/16-12h	Z649011912	66,14
1"	1"7/16-12h	Z649012316	120,52
1"1/4	1"11/16-12h	Z649012720	154,55
1"1/2	2"-12h	Z649013224	245,81

Interlock ORFS Male

Machos ORFS Interlock

Außengewinde ORFS Interlock

Mâle ORFS Interlock



DN	ROSCA THREAD	Referencia Part n°	€
3/4"	1"3/16-12h	Z649121912	115,49
1"	1"7/16-12h	Z649122316	171,62
1"1/4	1"11/16-12h	Z649122720	237,39
1"1/2	2"-12h	Z649123224	352,88

Interlock ORFS Swivel female (90° Elbow)

Hembras giratorias 90° ORFS Interlock

Dichtkopf 90° ORFS Interlock

Coude 90° femelle ORFS Interlock



DN	ROSCA THREAD	Referencia Part n°	€
3/4"	1"3/16-12h	Z649071912	186,04
1"	1"7/16-12h	Z649072316	270,10
1"1/4	1"11/16-12h	Z649072720	378,72
1"1/2	2"-12h	Z649073224	1.092,23

Interlock ORFS Swivel female (45° Elbow)

Hembras giratorias 45° ORFS Interlock

Dichtkopf 45° ORFS Interlock

Coude 45° femelle ORFS Interlock



DN	ROSCA THREAD	Referencia Part n°	€
3/4"	1"3/16-12h	Z649081912	186,04
12	1"7/16-12h	Z649082316	270,10
1"1/4	1"11/16-12h	Z649082720	378,72
1"1/2	2"-12h	Z649083224	1.092,23

Interlock series

Conexiones Interlock

Armaturen Interlock

Embouts Interlock

3000 PSI SAE Straight Flange Interlock / Code 61

Bridas rectas SAE 3000 PSI Interlock

Gerader Flansch SAE 3000 PSI Interlock

Bride SAE droite série 3000 PSI Interlock



DN	Ø	Referencia Part n°	€
3/4"	38,1	Z641821212	70,42
3/4"	44,5	Z641821612	82,62
1"	44,5	Z641821616	86,34
1"	50,8	Z641822016	100,84
1"1/4	50,8	Z641822020	110,72
1"1/4	60,3	Z641822420	167,63
1"1/2	60,3	Z641822424	165,51
1"1/2	71,4	Z641823224	293,68
2"	71,4	Z641823232	295,16

6000 PSI SAE Straight Flange Interlock / Code 62

Bridas Rectas SAE 6000 PSI Interlock

Gerader Flansch SAE 6000 PSI Interlock

Bride SAE droite série 6000 PSI Interlock



DN	Ø	Referencia Part n°	€
3/4"	41,3	Z642821212	71,52
3/4"	47,63	Z642821612	100,01
1"	47,63	Z642821616	104,65
1"	53,98	Z642822016	136,88
1"1/4	54	Z642822020	125,28
1"1/4	63,5	Z642822420	177,27
1"1/2	63,5	Z642822424	171,37
1"1/2	79,38	Z642823224	299,10
2"	79,38	Z642823232	310,34

3000 PSI SAE Flange Interlock (90° Elbow) / Code 61

Bridas 90° SAE 3000 PSI Interlock

Flansch 90° SAE 3000 PSI Interlock

Coude 90° bride SAE série 3000 PSI Interlock



DN	Ø	Referencia Part n°	€
3/4"	38,1	Z641831212	77,83
3/4"	44,45	Z641831612	109,77
1"	44,45	Z641831616	124,68
1"	50,8	Z641832016	166,35
1"1/4	50,8	Z641832020	171,75
1"1/4	60,33	Z641832420	238,10
1"1/2	60,3	Z641832424	259,77
1"1/2	71,4	Z641833224	397,24
2"	71,4	Z641833232	385,11

6000 PSI SAE Flange Interlock (90° Elbow) / Code 62

Bridas 90° SAE 6000 PSI Interlock

Flansch 90° SAE 6000 PSI Interlock

Coude 90° bride SAE série 6000 PSI Interlock



DN	Ø	Referencia Part n°	€
3/4"	41,3	Z642831212	102,48
3/4"	47,65	Z642831612	125,35
1"	47,65	Z642831616	148,50
1"	54	Z642832016	177,84
1"1/4	54	Z642832020	188,96
1"1/4	63,5	Z642832420	257,44
1"1/2	63,5	Z642832424	295,75
1"1/2	79,4	Z642833224	432,59
2"	79,4	Z642833232	409,01

3000 PSI SAE Flange Interlock (45° Elbow) / Code 61

Bridas 45° SAE 3000 PSI Interlock

Flansch 45° SAE 3000 PSI Interlock

Coude 45° bride SAE série 3000 PSI Interlock



DN	Ø	Referencia Part n°	€
3/4"	38,1	Z641841212	77,83
3/4"	44,5	Z641841612	109,77
1"	44,5	Z641841616	124,68
1"	50,8	Z641842016	166,35
1"1/4	50,8	Z641842020	171,75
1"1/4	60,3	Z641842420	238,10
1"1/2	60,3	Z641842424	259,77
2"	71,4	Z641843224	397,24
2"	71,4	Z641843232	385,11

6000 PSI SAE Flange Interlock (45° Elbow) / Code 62

Bridas 45° SAE 6000 PSI Interlock

Flansch 45° SAE 6000 PSI Interlock

Coude 45° bride SAE série 6000 PSI Interlock



DN	Ø	Referencia Part n°	€
3/4"	41,3	Z642841212	102,48
3/4"	47,6	Z642841612	125,35
1"	47,6	Z642841616	148,50
1"	54	Z642842016	177,84
1"1/4	54	Z642842020	188,96
1"1/4	63,5	Z642842420	257,44
1"1/2	63,5	Z642842424	295,75
1"1/2	79,4	Z642843224	432,59
2"	79,4	Z642843232	409,01

Ferrules for one piece fittings

Casquillos para conexiones una sola pieza
Pressfassungen für einteilige Armaturen
Jupes pour embouts pré-sertis

Ferrules R1AT/R2AT/1SN/2SN/R16/2SC/R17 for one piece fittings 43 series

Casquillos R1AT/R2AT/1SN/2SN /R16/2SC/R17 serie 43

Pressfassungen R1AT/R2AT/1SN/2SN/R16/2SC/R17 für einteilige Armaturen Serie 43

Jupes R1AT/R2AT/1SN/2SN/R16/2SC/R17 pour embouts pré-sertis série 43



DN	Referencia Part n°	€
1/4"	ZPFC221200400	10,30
5/16"	ZPFC221200500	13,93
3/8"	ZPFC221200600	12,13
1/2"	ZPFC221200800	14,09
5/8"	ZPFC221201000	17,34
3/4"	ZPFC221201200	24,38
1"	ZPFC221201600	41,95
1"1/4"	ZPFC221202000	73,91
1"1/2"	ZPFC221202400	91,58
2"	ZPFC221203200	136,67

Ferrules 3SP/4SP/R12/4SH standard series non skive

Casquillos 3SP/4SP/R12/4SH serie standard no pelar

Pressfassungen 3SP/4SP/R12/4SH Armaturen ohne Schälung

Jupes 3SP/4SP/R12/4SH série standard sans dénudage



DN	Referencia Part n°	€
3/8"	ZPF222400600	13,90
1/2"	ZPF222400800	15,93
5/8"	ZPF222401000	25,13
3/4"	ZPF222401200	24,02
1"	ZPF222401600	39,93
1"1/4"	ZPF222402000	65,57
1"1/2"	ZPF222402400	101,01
2"	ZPF222403200	140,20

Ferrules R7, R8 and braid of steel wire for one piece fittings

Casquillos R7, R8 y elastómero malla metálica una sola pieza

Pressfassungen R7/R8 und Elastomer/Metallumfl. für einteilige Armaturen

Jupes R7, R8 et elastomère tresse métallique pour embouts pré-sertis



DN	Referencia Part n°	€
3/16"	880120300	7,67
1/4"	880120400	8,36
5/16"	880120500	9,70
3/8"	880120600	10,38
1/2"	880120800	11,72
5/8"	880121000	17,59
3/4"	880121200	17,39
1"	880121600	29,65

Ferrules smooth PTFE for one piece fittings

Casquillos PTFE Liso una sola pieza

Pressfassungen für PTFE-Glattschläuche mit einteiligen Armaturen

Jupes PTFE Lisse pour embouts pré-sertis



DN	Referencia Part n°	€
1/4"	880400400	5,65
5/16"	880400500	7,08
3/8"	880400600	6,66
1/2"	880400800	8,15
5/8"	880401000	17,01

Ferrules convoluted PTFE for one piece fittings

Casquillos PTFE Corrugado una sola pieza

Pressfassungen für PTFE-Wellschläuche mit einteiligen Armaturen

Jupes PTFE Convoluté pour embouts pré-sertis



DN	Referencia Part n°	€
1/4"	880410400	6,44
5/16"	880410500	7,28
3/8"	880410600	6,88
1/2"	880410800	9,08
5/8"	880411000	13,34
3/4"	880411200	15,67

Ferrules 1SC/1SN/2SC/R6

Casquillos 1SC/1SN/2SC/R6

Pressfassungen 1SC/1SN/2SC/R6

Jupes 1SC/1SN/2SC/R6



DN	Referencia Part n°	€
1/4"	ZSCC21120400	9,72
5/16"	ZSCC21120500	11,77
3/8"	ZSCC21120600	12,07
1/2"	ZSCC21120800	13,89
5/8"	ZSCC21121000	20,06
3/4"	ZSCC21121200	28,33
1"	ZSCC21121600	39,88

Ferrules R13/R15 for fittings BW/BW+ series

Casquillos R13/R15 para serie BW/BW+

Pressfassungen R13/R15 für Armaturen Serie BW/BW+

Jupes R13/R15 pour embouts série BW/BW+



DN	Referencia Part n°	€
1"1/4"	ZAC690102000	97,06
1"1/2"	ZAC690102400	113,52
2"	ZAC690103200	191,31

One piece fittings 43 Series R1AT/R2AT/1SN/2SN/R16/2SC/R17

Conexiones una sola pieza Serie 43 R1AT/R2AT/1SN/2SN/R16/2SC/R17

Einteilige Armaturen Serie 43 R1AT/R2AT/1SN/2SN/R16/2SC/R17

Embouts pré-sertis R1AT/R2AT/1SN/2SN/R16/2SC/R17 Série 43

One piece double hexagonal JIC 37° Swivel female

Hembras giratorias rectas una sola pieza JIC 37°
doble hexagonal

Dichtkopf mit Ü-Mutter einteilig JIC 37° doppelt
6 kt

Femelle pré-sertie JIC 37° double hexagonal



One piece JIC 37° male

Machos una sola pieza rosca JIC 37°

Außengewinde einteilig JIC 37°

Mâle pré-serti JIC 37°



DN	ROSCA THREAD	Referencia Part n°	€
1/4"	7/16" 20h UNF	882420704	26,36
1/4"	1/2" 20h UNF	882420804	32,13
1/4"	9/16" 18h UNF	882420904	34,38
3/8"	9/16" 18h UNF	882420906	30,67
5/16"	1/2" 20h UNF	882420805	40,82
3/8"	3/4" 16h UNF	882421206	35,46
1/2"	3/4" 16h UNF	882421208	35,42
5/8"	3/4" 16h UNF	NEW 882421210	47,62
3/4"	3/4" 16h UNF	882421212	69,02
1/2"	7/8" 14h UNF	882421408	45,73
5/8"	7/8" 14h UNF	882421410	51,72
5/8"	1"1/16 12h UN	882421710	58,96
3/4"	1"1/16 12h UN	882421712	60,37
1"	1"1/16 12h UN	882421716	99,55
3/4"	1"5/16 12h UN	882422112	86,63
1"	1"5/16 12h UN	882422116	97,34
1"1/4"	1"5/8 12h UN	882422620	179,76
1"1/2"	1"7/8 12h UN	882423024	229,72
2"	2"1/2 12h UN	882424032	428,82

DN	ROSCA THREAD	Referencia Part n°	€
1/4"	7/16" 20h UNF	881400704	28,32
3/8"	9/16" 18h UNF	881400906	36,73
1/2"	3/4" 16h UNF	881401208	36,79
3/8"	7/8" 14h UNF	881401406	40,40
1/2"	7/8" 14h UNF	881401408	35,55
5/8"	7/8" 14h UNF	881401410	46,99
5/8"	1"1/16 12h UN	881401710	56,23
3/4"	1"1/16 12h UN	881401712	62,60
1"	1"1/16 12h UN	881401716	88,51
3/4"	1"5/16 12h UN	881402112	81,84
1"	1"5/16 12h UN	881402116	99,43
1"1/4"	1"5/8 12h UN	881402620	176,16
1"1/2"	1"7/8 12h UN	881403024	209,12
2"	2"1/2 12h UN	881404032	405,15

One piece JIC 37° Swivel female

Hembras giratorias rectas una sola pieza JIC 37°

Dichtkopf mit Ü-Mutter einteilig JIC 37°

Femelle pré-sertie JIC 37°



DN	ROSCA THREAD	Referencia Part n°	€
1/4"	7/16" 20h UNF	881420704	23,39
1/4"	1/2" 20h UNF	881420804	24,61
5/16"	1/2" 20h UNF	881420805	31,72
1/4"	9/16" 18h UNF	881420904	26,43
5/16"	9/16" 18h UNF	881420905	28,86
3/8"	9/16" 18h UNF	881420906	26,69
3/8"	3/4" 16h UNF	881421206	31,19
1/2"	3/4" 16h UNF	881421208	32,45
1/2"	7/8" 14h UNF	881421408	34,01
5/8"	7/8" 14h UNF	881421410	40,88
1/2"	1"1/16 12h UN	881421708	50,83
5/8"	1"1/16 12h UN	881421710	49,50
3/4"	1"1/16 12h UN	881421712	52,02
1"	1"1/16 12h UN	881421716	92,97
3/4"	1"5/16 12h UN	881422112	67,53
1"	1"5/16 12h UN	881422116	85,17
5/8"	1"5/8 12h UN	881422616	116,86
1"1/4"	1"5/8 12h UN	881422620	149,16
1"1/2"	1"7/8 12h UN	881423024	195,16
2"	2"1/2 12h UN	881424032	337,95

One piece fittings 43 Series R1AT/R2AT/1SN/2SN/R16/2SC/R17

Conexiones una sola pieza Serie 43 R1AT/R2AT/1SN/2SN/R16/2SC/R17

Einteilige Armaturen Serie 43 R1AT/R2AT/1SN/2SN/R16/2SC/R17

Embouts pré-sertis R1AT/R2AT/1SN/2SN/R16/2SC/R17 Série 43

One piece JIC 37° Swivel female (90° Elbow)

Hembras giratorias 90° una sola pieza JIC 37°

Dichtkopf einteilig Ü-Mutter 37° JIC 90°

Coude 90° femelle pré-sertie JIC 37°



DN	ROSCA THREAD	Referencia Part n°	€
1/4"	7/16" 20h UNF	881380704	30,64
5/16"	1/2" 20h UNF	881380805	48,36
1/4"	9/16" 18h UNF	881380904	44,72
5/16"	9/16" 18h UNF	NEW 881380905	40,67
3/8"	9/16" 18h UNF	881380906	37,62
3/8"	3/4" 16h UNF	881381206	46,10
1/2"	3/4" 16h UNF	881381208	44,37
1/2"	7/8" 14h UNF	881381408	46,90
5/8"	7/8" 14h UNF	881381410	57,82
5/8"	1"1/16 12h UN	NEW 881381710	72,70
3/4"	1"1/16 12h UN	881381712	77,47
3/4"	1"5/16 12h UN	881382112	111,71
1"	1"5/16 12h UN	881382116	125,02
1"1/4"	1"5/8 12h UN	881382620	209,35
1"1/2"	1"7/8 12h UN	881383024	306,05
2"	2"1/2 12h UN	881384032	598,55

One piece JIC 37° Swivel female (45° Elbow)

Hembras giratorias 45° una sola pieza JIC 37°

Dichtkopf JIC 37° einteilig 45°

Coude 45° femelle pré-sertie JIC 37°



DN	ROSCA THREAD	Referencia Part n°	€
1/4"	7/16" 20h UNF	881390704	30,96
1/4"	9/16" 18h UNF	881390904	44,72
3/8"	9/16" 18h UNF	881390906	37,62
3/8"	3/4" 16h UNF	881391206	46,09
1/2"	3/4" 16h UNF	881391208	44,37
1/2"	7/8" 14h UNF	881391408	46,90
5/8"	7/8" 14h UNF	881391410	57,82
3/4"	1"1/16 12h UN	881391712	77,48
1"	1"5/16 12h UN	881392116	125,02
1"1/4"	1"5/8 12h UN	881392620	209,35
1"1/2"	1"7/8 12h UN	881393024	306,05
2"	2"1/2 12h UN	881394032	598,54

One piece fittings 43 Series R1AT/R2AT/1SN/2SN/R16/2SC/R17

Conexiones una sola pieza Serie 43 R1AT/R2AT/1SN/2SN/R16/2SC/R17

Einteilige Armaturen Serie 43 R1AT/R2AT/1SN/2SN/R16/2SC/R17

Embouts pré-sertis R1AT/R2AT/1SN/2SN/R16/2SC/R17 Série 43

One piece double hexagonal ORFS Swivel female

Hembras giratorias rectas una sola pieza ORFS
doble hexagonal

Dichtkopf mit ORFS einteilig Ü-Mutter doppelt 6 kt

Femelle pré-sertie ORFS double hexagonal



DN	ROSCA THREAD	Referencia Part n°	€
1/4"	9/16"-18h	889000904	40,14
1/4"	11/16"-16h	889001104	50,74
3/8"	11/16"-16h	889001106	45,39
3/8"	13/16"-16h	889001306	54,43
1/2"	13/16"-16h	889001308	51,69
1/2"	1"-14h	889001608	87,12
5/8"	1"-14h	889001610	74,12
1/2"	1" 3/16-12h	889001908	98,66
5/8"	1" 3/16-12h	889001910	96,27
3/4"	1" 3/16-12h	889001912	84,21
3/4"	1" 7/16-12h	889002312	119,48
1"	1" 7/16-12h	889002316	143,85
1" 1/4	1" 11/16-12h	889002720	231,30
1" 1/2	2"-12h	889003224	274,63

One piece ORFS Swivel female (90° Elbow)

Hembras giratorias 90° una sola pieza ORFS

Dichtkopf 90° ORFS einteilig

Coude 90° femelle pré-sertie ORFS



DN	ROSCA THREAD	Referencia Part n°	€
1/4"	9/16"-18h	889070904	65,49
1/4"	11/16"-16h	889071104	79,85
3/8"	11/16"-16h	889071106	78,14
3/8"	13/16"-16"	889071306	84,98
1/2"	13/16"-16h	889071308	90,55
1/2"	1"-14h	889071608	123,17
5/8"	1"-14h	889071610	114,14
3/4"	1" 3/16-12h	889071912	146,08
3/4"	1-7/16-12h	889072312	204,88
1"	1" 7/16-12h	889072316	218,56
1" 1/4	1" 11/16-12h	889072720	323,38
1" 1/2	2"-12h	889073224	801,27

One piece ORFS male

Machos una sola pieza ORFS

Außengewinde ORFS

Mâle pré-serti ORFS



DN	ROSCA THREAD	Referencia Part n°	€
1/4"	9/16"-18h	889120904	46,15
3/8"	11/16"-16h	889121106	46,18
1/2"	13/16"-16h	889121308	56,44
5/8"	1"-14h	889121610	79,26
3/4"	1" 3/16-12h	889121912	101,58
1"	1" 7/16-12h	889122316	147,91
1" 1/4	1" 11/16-12h	889122720	221,84
1" 1/2	2"-12h	889123224	309,85

One piece ORFS Swivel female (45° Elbow)

Hembras giratorias 45° una sola pieza ORFS

Dichtkopf 45° ORFS einteilig

Coude 45° femelle pré-sertie ORFS



DN	ROSCA THREAD	Referencia Part n°	€
1/4"	9/16"-18h	889080904	65,49
1/4"	11/16"-16h	889081104	79,86
3/8"	11/16"-16h	889081106	78,14
3/8"	13/16"-16h	889081306	84,98
1/2"	13/16"-16h	889081308	90,56
1/2"	1"-14h	889081608	123,17
5/8"	1"-14h	889081610	114,14
3/4"	1" 3/16-12h	889081912	146,08
3/4"	1" 7/16-12h	889082312	204,88
1"	1" 7/16-12h	889082316	218,56
1" 1/4	1" 11/16-12h	889082720	323,38
1" 1/2	2"-12h	889083224	801,27

One piece fittings 43 Series R1AT/R2AT/1SN/2SN/R16/2SC/R17

Conexiones una sola pieza Serie 43 R1AT/R2AT/1SN/2SN/R16/2SC/R17

Einteilige Armaturen Serie 43 R1AT/R2AT/1SN/2SN/R16/2SC/R17

Embouts pré-sertis R1AT/R2AT/1SN/2SN/R16/2SC/R17 Série 43

One piece double hexagonal NPSM Swivel female 60° cone

Hembras gir rectas una sola pieza rosca NPSM (60°) doble hex

Dichtkopf mit NPSM einteilig Ü-Mutter 60° kon. doppelt 6 kt

Femelle pré-sertie NPSM cône 60° double hexagonal



DN	ROSCA THREAD	Referencia Part n°	€
1/4"	1/4" 18h NPSM	883610404	37,10
3/8"	3/8" 18h NPSM	883610606	39,74
1/2"	1/2" 14h NPSM	883610808	46,63
3/4"	3/4" 14h NPSM	883611212	72,22
1"	1" - 11 1/2 h NPSM	883611616	116,86

One piece NPSM Swivel female 60° cone

Hembras giratorias rectas una sola pieza rosca NPSM cono 60°

Dichtkopf mit NPSM einteilig Ü-Mutter 60° kon.

Femelle pré-sertie NPSM cône 60°



DN	ROSCA THREAD	Referencia Part n°	€
1/4"	1/4" 18h NPSM	882610404	26,45
3/8"	3/8" 18h NPSM	882610606	29,06
1/2"	1/2" 14h NPSM	882610808	37,74
3/4"	3/4" 14h NPSM	882611212	58,32
1"	1" - 11 1/2 h NPSM	882611616	95,27
1"1/4	1"1/4 - 11 1/2 h NPSM	882612020	174,23

One piece NPSM Swivel female 60° cone (90° Elbow)

Hembras giratorias 90° una sola pieza rosca NPSM cono 60°

Dichtkopf mit NPSM Ü-Mutter 60° kon. 90° einteilig

Coude 90° femelle pré-sertie NPSM cône 60°



DN	ROSCA THREAD	Referencia Part n°	€
1/4"	1/4" 18h NPSM	882620404	36,14
3/8"	3/8" 18h NPSM	882620606	41,98
1/2"	1/2" 14h NPSM	882620808	55,59
3/4"	3/4" 14h NPSM	882621212	84,43
1"	1" - 11 1/2 h NPSM	882621616	130,53

One piece NPSM Swivel female 60° cone (45° Elbow)

Hembras giratorias 45° una sola pieza rosca NPSM cono 60°

Dichtkopf mit NPSM Ü-Mutter 60° CON. 45° einteilig kon.

Coude 45° femelle pré-sertie NPSM cône 60°



DN	ROSCA THREAD	Referencia Part n°	€
1/4"	1/4" 18h NPSM	882630404	36,15
3/8"	3/8" 18h NPSM	882630606	41,98
1/2"	1/2" 14h NPSM	882630808	55,59
3/4"	3/4" 14h NPSM	882631212	84,44
1"	1" - 11 1/2 h NPSM	882631616	130,53

One piece NPT male pipe straight

Machos una sola pieza rosca cónica NPT

Außengewinde einteilig kon. NPT

Mâle pré-serti NPT



DN	ROSCA THREAD	Referencia Part n°	€
1/4"	1/8" NPT	881610204	29,29
1/4"	1/4" NPT	881610404	23,32
3/8"	1/4" NPT	881610406	33,38
1/4"	3/8" NPT	881610604	31,33
3/8"	3/8" NPT	881610606	26,71
1/2"	3/8" NPT	881610608	40,04
1/4"	1/2" NPT	881610804	43,73
3/8"	1/2" NPT	881610806	39,67
1/2"	1/2" NPT	881610808	33,23
5/8"	1/2" NPT	881610810	42,73
3/4"	1/2" NPT	881610812	59,48
1/2"	3/4" NPT	881611208	52,26
5/8"	3/4" NPT	881611210	54,95
3/4"	3/4" NPT	881611212	54,30
3/4"	1" NPT	881611612	80,99
1"	1" NPT	881611616	90,77
1"1/4	1"1/4 NPT	881612020	164,10
1"1/2	1"1/2 NPT	881612424	196,39
2"	2" NPT	881613232	321,50

One piece NPT swivel male

Machos giratorios una sola pieza rosca cónica NPT

Außengewinde einteilig kon. NPT

Mâle tournant pré-serti NPT



DN	ROSCA THREAD	Referencia Part n°	€
1/4"	1/4" NPT	881650404	54,98
3/8"	3/8" NPT	881650606	57,68
3/8"	1/2" NPT	881650806	82,83
1/2"	1/2" NPT	881650808	63,78
1/2"	3/4" NPT	881651208	98,02
3/4"	3/4" NPT	881651212	95,26
1"	1" NPT	881651616	146,80

One piece fittings 43 Series R1AT/R2AT/1SN/2SN/R16/2SC/R17

Conexiones una sola pieza Serie 43 R1AT/R2AT/1SN/2SN/R16/2SC/R17

Einteilige Armaturen Serie 43 R1AT/R2AT/1SN/2SN/R16/2SC/R17

Embouts pré-sertis R1AT/R2AT/1SN/2SN/R16/2SC/R17 Série 43

One piece 3000 PSI SAE Straight Flange / Code 61

Bridas rectas una sola pieza SAE 3000 PSI

Gerader Kompaktflansch SAE 3000 PSI

Bride SAE droite pré-sertie série 3000 PSI



DN	∅	Referencia Part n°	€
1/2"	30.2	881820808	54,43
1/2"	38.1	881821208	80,55
3/4"	38.1	881821212	81,08
3/4"	44.5	881821612	106,53
1"	44.5	881821616	114,58
1"	50.8	881822016	149,88
1"1/4	50.8	881822020	175,49
1"1/4	60.3	881822420	241,79
1"1/2	60.3	881822424	221,97
1"1/2	71.4	881823224	352,27
2"	71.4	881823232	363,18

One piece 3000 PSI SAE Flange (90° Elbow)/ Code 61

Bridas 90° una sola pieza SAE 3000 PSI

Kompaktflansch 90° SAE 3000 PSI

Bride SAE coude 90° pré-sertie série 3000 PSI



DN	∅	Referencia Part n°	€
1/2"	30.2	881830808	73,36
1/2"	38.1	881831208	91,05
3/4"	38.1	881831212	107,55
3/4"	44.5	881831612	163,75
1"	44.5	881831616	151,09
1"	50.8	881832016	209,94
1"1/4	50.8	881832020	254,57
1"1/4	60.3	881832420	322,00
1"1/2	60.3	881832424	323,29
1"1/2	71.4	881833224	463,22
2"	71.4	881833232	528,68

One piece 3000 PSI SAE Flange (45° Elbow)/ Code 61

Bridas 45° una sola pieza SAE 3000 PSI

Kompaktflansch 45° SAE 3000 PSI

Bride SAE coude 45° pré-sertie série 3000 PSI



DN	∅	Referencia Part n°	€
1/2"	30.2	881840808	73,36
1/2"	38.1	881841208	91,05
3/4"	38.1	881841212	107,55
3/4"	44.5	881841612	163,75
1"	44.5	881841616	151,09
1"	50.8	881842016	209,93
1"1/4	50.8	881842020	254,57
1"1/4	60.3	881842420	322,00
1"1/2	60.3	881842424	323,29
2"	71.4	881843232	528,68

One piece 6000 PSI SAE Straight Flange / Code 62

Bridas rectas una sola pieza SAE 6000 PSI

Gerader Kompaktflansch SAE 6000 PSI

Bride SAE droite pré-sertie série 6000 PSI



DN	∅	Referencia Part n°	€
1/2"	31.8	882820808	61,29
3/4"	41.3	882821212	88,80
1"	47.6	882821616	125,29
1"1/4	54	882822020	191,70
1"1/2	63.5	882822424	281,15
2"	79.4	882823232	489,85

One piece 6000 PSI SAE Flange (90° Elbow)/ Code 62

Bridas 90° una sola pieza SAE 6000 PSI

Kompaktflansch 90° SAE 6000 PSI

Bride SAE coude 90° pré-sertie série 6000 PSI



DN	∅	Referencia Part n°	€
1/2"	31.8	882830808	76,79
3/4"	41.3	882831212	121,55
1"	47.6	882831616	172,91
1"1/4	54	882832020	261,83
1"1/2	63.5	882832424	416,04
2"	79.4	882833232	600,75

One piece 6000 PSI SAE Flange (45° Elbow)/ Code 62

Bridas 45° una sola pieza SAE 6000 PSI

Kompaktflansch 45° SAE 6000 PSI

Bride SAE coude 45° pré-sertie série 6000 PSI



DN	∅	Referencia Part n°	€
1/2"	31.8	882840808	76,79
3/4"	41.3	882841212	121,55
1"	47.6	882841616	172,91
1"1/4	54	882842020	261,82
1"1/2	63.5	882842424	416,04
2"	79.4	882843232	600,75

One piece fittings 43 Series R1AT/R2AT/1SN/2SN/R16/2SC/R17

Conexiones una sola pieza Serie 43 R1AT/R2AT/1SN/2SN/R16/2SC/R17

Einteilige Armaturen Serie 43 R1AT/R2AT/1SN/2SN/R16/2SC/R17

Emboutis pré-sertis R1AT/R2AT/1SN/2SN/R16/2SC/R17 Série 43

One piece Metric female cone 24°

Hembras gir rectas una sola pieza rosca Métrica cono 24° - DKO

Dichtkopf metr. einteilig Ü-Mutter kon. 24°

Femelle pré-sertie Métrique cône 24°



DN	TUBO PIPE	SERIE SERIES	ROSCA THREAD	Referencia Part n°	€
1/4"	6	L	M12x1.5	88804120604	23,88
1/4"	8	L	M14x1.5	88804140804	22,65
1/4"	10	L	M16x1.5	88804161004	24,33
3/8"	10	L	M16x1.5	88804161006	28,34
5/16"	10	L	M16x1.5	88804161005	27,96
1/4"	12	L	M18x1.5	88804181204	29,92
3/8"	12	L	M18x1.5	88804181206	27,20
1/2"	12	L	M18x1.5	88804181208	43,23
3/8"	15	L	M22x1.5	88804221506	32,84
1/2"	15	L	M22x1.5	88804221508	34,08
1/2"	18	L	M26x1.5	88804261808	43,25
5/8"	18	L	M26x1.5	88804261810	44,57
3/4"	18	L	M26x1.5	88804261812	71,03
3/4"	22	L	M30x2	88804302212	57,63
1"	28	L	M36x2	88804362816	94,32
1"1/4	35	L	M45x2	88804453520	149,21
1"1/4	42	L	M52x2	88804524220	216,11
1"1/2	42	L	M52x2	88804524224	202,97
1/4"	8	S	M16x1.5	88804160804	24,44
1/4"	10	S	M18x1.5	88804181004	26,68
1/4"	12	S	M20x1.5	88804201204	40,91
3/8"	12	S	M20x1.5	88804201206	30,08
1/2"	12	S	M20x1.5	88804201208	43,28
3/8"	16	S	M24x1.5	88804241606	38,12
1/2"	16	S	M24x1.5	88804241608	34,25
5/8"	20	S	M30x2	88804302010	47,75
3/4"	20	S	M30x2	88804302012	65,26
3/4"	25	S	M36x2	88804362512	77,99
1"	25	S	M36x2	88804362516	110,81
1"	30	S	M42x2	88804423016	113,88
1"1/4	38	S	M52x2	88804523820	195,33

One piece Metric male cone 24°

Machos una sola pieza rosca Métrica cono 24°

Außengewinde einteilig metr. kon. 24°

Mâle pré-serti Métrique cône 24°



DN	TUBO PIPE	SERIE	ROSCA THREAD	Referencia Part n°	€
1/4"	6	L	M12x1.5	88203120604	28,66
1/4"	8	L	M14x1.5	88203140804	26,40
5/16"	10	L	M16x1.5	88203161005	34,80
3/8"	10	L	M16x1.5	88203161006	31,88
3/8"	12	L	M18x1.5	88203181206	25,59
1/2"	15	L	M22x1.5	88203221508	34,13
1/2"	18	L	M26x1.5	88203261808	45,40
5/8"	18	L	M26x1.5	88203261810	44,01
3/4"	22	L	M30x2	88203302212	63,30
1"	28	L	M36x2	88203362816	99,85
1"1/4	35	L	M45x2	88203453520	173,02
1"1/2	42	L	M52x2	88203524224	238,67
1/4"	8	S	M16x1.5	88203160804	32,31
1/4"	10	S	M18x1.5	88203181004	34,96
3/8"	12	S	M20x1.5	88203201206	34,44
1/2"	16	S	M24x1.5	88203241608	37,25
5/8"	20	S	M30x2	88203302010	53,86
3/4"	20	S	M30x2	88203302012	71,53
3/4"	25	S	M36x2	88203362512	86,14
1"	25	S	M36x2	88203362516	113,38
1"	30	S	M42x2	88203423016	138,68
1"1/4	38	S	M52x2	88203523820	223,63

One piece fittings 43 Series R1AT/R2AT/1SN/2SN/R16/2SC/R17

Conexiones una sola pieza Serie 43 R1AT/R2AT/1SN/2SN/R16/2SC/R17

Einteilige Armaturen Serie 43 R1AT/R2AT/1SN/2SN/R16/2SC/R17

Embouts pré-sertis R1AT/R2AT/1SN/2SN/R16/2SC/R17 Série 43

One piece Metric female cone 24° (90° Elbow)

Hembras gir 90° una sola pieza Métricas cono 24°
- DKO 90°

Dichtkegel mit Ü-Mutter 90° Bogen einteilig

Coude 90° femelle pré-sertie Métrique cône 24°



One piece Metric female cone 24° (45° Elbow)

Hembras gir 45° una sola pieza Métricas cono 24°
- DKO 45°

Dichtkegel mit Ü-Mutter 45° Bogen einteilig

Coude 45° femelle pré-sertie Métrique cône 24°



DN	TUBO PIPE	SERIE SERIES	ROSCA THREAD	Referencia Part n°	€
1/4"	6	L	M12x1.5	88305120604	32,44
1/4"	8	L	M14x1.5	88305140804	31,43
1/4"	10	L	M16x1.5	88305161004	34,87
5/16"	10	L	M16x1.5	88305161005	40,33
3/8"	10	L	M16x1.5	88305161006	39,11
1/4"	12	L	M18x1.5	88305181204	43,51
3/8"	12	L	M18x1.5	88305181206	37,18
1/2"	15	L	M22x1.5	88305221508	45,42
5/8"	18	L	M26x1.5	88305261810	61,87
3/4"	22	L	M30x2	88305302212	83,54
1"	28	L	M36x2	88305362816	130,32
1 1/4"	35	L	M45x2	88305453520	221,08
1 1/2"	42	L	M52x2	88305524224	321,52
1/4"	8	S	M16x1.5	88305160804	35,72
1/4"	10	S	M18x1.5	88305181004	36,25
1/4"	12	S	M20x1.5	88305201204	44,42
5/16"	12	S	M20x1.5	88305201205	49,98
3/8"	12	S	M20x1.5	88305201206	42,02
1/2"	16	S	M24x1.5	88305241608	48,04
5/8"	20	S	M30x2	88305302010	70,94
3/4"	20	S	M30x2	88305302012	86,69
3/4"	25	S	M36x2	88305362512	110,54
1"	25	S	M36x2	88305362516	147,15
1"	30	S	M42x2	88305423016	169,15
1 1/4"	38	S	M52x2	88305523820	291,52

DN	TUBO PIPE	SERIE	ROSCA THREAD	Referencia Part n°	€
1/4"	6	L	M12x1.5	88306120604	32,45
1/4"	8	L	M14x1.5	88306140804	31,43
1/4"	10	L	M16x1.5	88306161004	34,87
5/16"	10	L	M16x1.5	88306161005	40,33
3/8"	10	L	M16x1.5	88306161006	39,11
3/8"	12	L	M18x1.5	88306181206	37,18
3/8"	15	L	M22x1.5	88306221506	52,33
1/2"	15	L	M22x1.5	88306221508	45,42
1/2"	18	L	M26x1.5	88306261808	61,28
5/8"	18	L	M26x1.5	88306261810	61,87
3/4"	22	L	M30x2	88306302212	83,54
1"	28	L	M36x2	88306362816	130,32
1 1/4"	35	L	M45x2	88306453520	221,08
1 1/2"	42	L	M52x2	88306524224	321,52
1/4"	8	S	M16x1.5	88306160804	35,72
1/4"	10	S	M18x1.5	88306181004	36,25
1/4"	12	S	M20x1.5	88306201204	44,42
3/8"	10	S	M18x1.5	88306181006	46,82
3/8"	12	S	M20x1.5	88306201206	42,02
3/8"	14	S	M22x1.5	88306221406	52,58
1/2"	16	S	M24x1.5	88306241608	48,04
5/8"	20	S	M30x2	88306302010	70,94
3/4"	20	S	M30x2	88306302012	86,69
3/4"	25	S	M36x2	88306362512	110,54
1"	25	S	M36x2	88306362516	147,15
1"	30	S	M42x2	88306423016	169,15
1 1/4"	38	S	M52x2	88306523820	291,52

One piece fittings 43 Series R1AT/R2AT/1SN/2SN/R16/2SC/R17

Conexiones una sola pieza Serie 43 R1AT/R2AT/1SN/2SN/R16/2SC/R17

Einteilige Armaturen Serie 43 R1AT/R2AT/1SN/2SN/R16/2SC/R17

Embouts pré-sertis R1AT/R2AT/1SN/2SN/R16/2SC/R17 Série 43

One piece double hexagonal BSP female 60° cone

Hembras giratorias rectas una sola pieza rosca BSP (60°) doble hex

Dichtkopf mit Ü-Mutter einteilig BSP 60° kon. doppelt 6 kt

Femelle pré-sertie BSP cône 60° double hexagonal



DN	ROSCA THREAD	Referencia Part n°	€
1/4"	1/4" BSP	884000404	31,95
5/16"	3/8" BSP	884000605	39,37
3/8"	3/8" BSP	884000606	36,01
1/2"	1/2" BSP	884000808	38,72
3/4"	3/4" BSP	884001212	70,95
1"	1" BSP	884001616	104,76
1"1/4	1"1/4 BSP	884002020	168,93
1"1/2	1"1/2 BSP	884002424	238,16
2"	2" BSP	884003232	396,93

One piece BSP female 60° cone

Hembras giratorias rectas una sola pieza rosca BSP cono 60°

Dichtkopf mit Ü-Mutter einteilig BSP 60° kon.

Femelle pré-sertie BSP cône 60°



DN	ROSCA THREAD	Referencia Part n°	€
1/4"	1/4" BSP	881000404	21,76
1/4"	3/8" BSP	881000604	26,09
5/16"	3/8" BSP	881000605	29,66
3/8"	3/8" BSP	881000606	26,14
1/2"	3/8" BSP	881000608	30,91
3/8"	1/2" BSP	881000806	30,44
1/2"	1/2" BSP	881000808	31,15
5/8"	1/2" BSP	881000810	42,75
5/8"	5/8" BSP	881001010	51,58
1/2"	3/4" BSP	881001208	43,98
5/8"	3/4" BSP	881001210	44,99
3/4"	3/4" BSP	881001212	51,65
3/4"	1" BSP	881001612	68,42
1"	1" BSP	881001616	85,21
1"1/4	1"1/4 BSP	881002020	150,12
1"1/2	1"1/2 BSP	881002424	182,23
2"	2" BSP	881003232	301,73

One piece BSP female flat seat

Hembras giratorias rectas compactas rosca BSP asiento plano

Dichtkopf mit Ü-Mutter einteilig BSP flachdichtend

Femelle pré-sertie BSP fond plat



DN	ROSCA THREAD	Referencia Part n°	€
1/4"	1/4" BSP	882000404	23,95
3/8"	3/8" BSP	882000606	27,64
1/2"	1/2" BSP	882000808	33,75
3/4"	3/4" BSP	882001212	53,75
1"	1" BSP	882001616	89,59

One piece BSP female cone 60° (90° Elbow)

Hembras giratorias 90° una sola pieza rosca BSP cono 60°

Dichtkopf BSP Ü-Mutter einteilig 60° kon. 90°

Coude 90° femelle pré-sertie BSP cône 60°



DN	ROSCA THREAD	Referencia Part n°	€
1/4"	1/4" BSP	881070404	29,60
1/4"	3/8" BSP	881070604	37,49
3/8"	3/8" BSP	881070606	34,87
1/2"	3/8" BSP	881070608	64,19
3/8"	1/2" BSP	881070806	48,33
1/2"	1/2" BSP	881070808	41,88
5/8"	5/8" BSP	881071010	75,55
5/8"	3/4" BSP	881071210	70,56
3/4"	3/4" BSP	881071212	75,56
3/4"	1" BSP	881071612	99,04
1"	1" BSP	881071616	121,77
1"1/4	1"1/4 BSP	881072020	211,20
1"1/2	1"1/2 BSP	881072424	299,40
2"	2" BSP	881073232	520,24

One piece BSP female cone 60° (45° Elbow)

Hembras giratorias 45° una sola pieza rosca BSP cono 60°

Dichtkopf mit BSP Ü-Mutter 60° einteilig 45° kon.

Coude 45° femelle pré-sertie BSP cône 60°



DN	ROSCA THREAD	Referencia Part n°	€
1/4"	1/4" BSP	881080404	29,60
3/8"	3/8" BSP	881080606	34,87
3/8"	1/2" BSP	881080806	48,33
1/2"	1/2" BSP	881080808	41,89
3/4"	3/4" BSP	881081212	75,55
1"	1" BSP	881081616	121,77
1"1/4	1"1/4 BSP	881082020	211,21
1"1/2	1"1/2 BSP	881082424	299,40
2"	2" BSP	881083232	520,24

One piece BSP male 60° cone

Machos una sola pieza rosca cilíndrica BSP cono 60°

Außengewinde zyl. einteilig kon. BSP 60°

Mâle pré-serti BSP cône 60°



DN	ROSCA THREAD	Referencia Part n°	€
1/4"	1/4" BSP	881120404	24,25
3/8"	3/8" BSP	881120606	28,18
3/8"	1/2" BSP	881120806	35,17
1/2"	1/2" BSP	881120808	35,33
5/8"	3/4" BSP	NEW 881121210	58,11
3/4"	3/4" BSP	881121212	55,34
3/4"	1" BSP	881121612	84,10
1"	1" BSP	881121616	101,61
1"1/4	1"1/4 BSP	881122020	177,87
1"1/2	1"1/2 BSP	881122424	212,89
2"	2" BSP	881123232	340,97

One piece fittings BWS Series 3SP/4SP/R12/4SH No Skive

Conexiones una sola pieza Serie BWS 3SP/4SP/R12/4SH No Pelar
Einteilige Armaturen Serie BWS 3SP/4SP/R12/4SH ohne Schälung
Embouts pré-ertis Série BWS 3SP/4SP/R12/4SH Sans dénuder

R13 & R15 Ø 3/4" - 1"

One piece double hexagonal JIC 37° Swivel female

Hembras giratorias rectas una sola pieza JIC 37°
doble hexagonal
Dichtkopf mit Ü-Mutter einteilig JIC 37° doppelt
6 kt

Femelle pré-sertie JIC 37° double hexagonal



One piece JIC 37° Swivel female

Hembras giratorias rectas una sola pieza JIC 37°

Dichtkopf mit Ü-Mutter einteilig JIC 37°

Femelle pré-sertie JIC 37°



DN	ROSCA THREAD	Referencia Part n°	€
3/8"	9/16" 18h UNF	Z582420906	33,77
1/2"	3/4" 16h UNF	Z582421208	38,76
1/2"	7/8" 14h UNF	Z582421408	49,47
5/8"	7/8" 14h UNF	Z582421410	62,13
3/4"	1"1/16 12h UN	Z582421712	62,31
1"	1"1/16 12h UN	Z582421716	101,19
1"	1"5/16 12h UN	Z582422116	98,90
1"1/4	1"5/8 12h UN	Z582422620	177,66
1"1/2	1"7/8 12 UN	Z582423024	248,74
2"	2"1/2 12h UN	Z582424032	449,12

DN	ROSCA THREAD	Referencia Part n°	€
3/8"	9/16" 18h UNF	Z581420906	29,63
1/2"	3/4" 16h UNF	Z581421208	35,68
5/8"	7/8" 14h UNF	Z581421410	50,87
3/4"	1"1/16 12h UN	Z581421712	53,63
1"	1"5/16 12h UN	Z581422116	86,25
1"	1"5/8 12h UN	Z581422616	119,16
1"1/4	1"5/8 12h UN	Z581422620	145,88
1"1/2	1"7/8 12 UN	Z581423024	212,85
2"	2"1/2 12h UN	Z581424032	354,75

One piece JIC 37° Swivel female (90° Elbow)

Hembras giratorias 90° una sola pieza JIC 37°

Dichtkopf einteilig Ü-Mutter 37° JIC 90°

Coude 90° femelle pré-sertie JIC 37°



One piece JIC 37° Swivel female (45° Elbow)

Hembras giratorias 45° una sola pieza JIC 37°

Dichtkopf JIC 37° einteilig 45°

Coude 45° femelle pré-sertie JIC 37°



DN	ROSCA THREAD	Referencia Part n°	€
3/8"	9/16" 18h UNF	Z581380906	40,98
1/2"	3/4" 16h UNF	Z581381208	48,05
5/8"	7/8" 14h UNF	Z581381410	68,46
3/4"	1"1/16 12h UN	Z581381712	80,06
1"	1"5/16 12h UN	Z581382116	127,64
1"1/4	1"5/8 12h UN	Z581382620	208,38
1"1/2	1"7/8 12 UN	Z581383024	328,01
2"	2"1/2 12h UN	Z581384032	625,37

DN	ROSCA THREAD	Referencia Part n°	€
3/8"	9/16" 18h UNF	Z581390906	40,98
1/2"	3/4" 16h UNF	Z581391208	48,06
5/8"	7/8" 14h UNF	Z581391410	68,46
3/4"	1"1/16 12h UN	Z581391712	80,07
1"	1"5/16 12h UN	Z581392116	127,64
1"1/4	1"5/8 12h UN	Z581392620	208,38
1"1/2	1"7/8 12 UN	Z581393024	328,01
2"	2"1/2 12h UN	Z581394032	625,37

One piece JIC 37° male

Machos una sola pieza rosca JIC 37°

Außengewinde einteilig JIC 37°

Mâle pré-serti JIC 37°



DN	ROSCA THREAD	Referencia Part n°	€
3/8"	9/16" 18h UNF	Z581400906	40,05
1/2"	3/4" 16h UNF	Z581401208	40,19
5/8"	7/8" 14h UNF	Z581401410	57,22
3/4"	1"1/16 12h UN	Z581401712	64,62
1"	1"5/16 12h UN	Z581402116	101,06
1"1/4	1"5/8 12h UN	Z581402620	173,92
1"1/2	1"7/8 12 UN	Z581403024	227,35
2"	2"1/2 12h UN	Z581404032	424,54

One piece fittings BWS Series 3SP/4SP/R12/4SH No Skive

Conexiones una sola pieza Serie BWS 3SP/4SP/R12/4SH No Pelar
Einteilige Armaturen Serie BWS 3SP/4SP/R12/4SH ohne Schälung
Embouts pré-sertis Série BWS 3SP/4SP/R12/4SH Sans dénuder

R13 & R15 Ø 3/4" - 1"

One piece double hexagonal ORFS Swivel female

Hembras giratorias rectas una sola pieza ORFS
doble hexagonal

Dichtkopf mit ORFS einteilig Ü-Mutter doppelt 6 kt

Femelle pré-sertie ORFS double hexagonal



DN	ROSCA THREAD	Referencia Part n°	€
3/8"	11/16" 16h UN	Z589001106	49,05
1/2"	13/16" 16h UN	Z589001308	55,66
5/8"	1" 14h UNS	Z589001610	85,39
3/4"	1"3/16 12h UN	Z589001912	87,06
1"	1"7/16 12h UN	Z589002316	147,19
1"1/4	1"11/16 12h UN	Z589002720	231,18
1"1/2	2" 12h UN	Z589003224	295,38

One piece ORFS Swivel female (90° Elbow)

Hembras giratorias 90° una sola pieza ORFS

Dichtkopf 90° ORFS einteilig

Coude 90° femelle pré-sertie ORFS



DN	ROSCA THREAD	Referencia Part n°	€
3/8"	11/16" 16h UN	Z589071106	83,06
1/2"	13/16" 16h UN	Z589071308	96,02
5/8"	1" 14h UNS	Z589071610	126,95
3/4"	1"3/16 12h UN	Z589071912	151,31
1"	1"7/16 12h UN	Z589072316	224,78
1"1/4	1"11/16 12h UN	Z589072720	326,81
1"1/2	2" 12h UN	Z589073224	842,27

One piece ORFS male

Machos una sola pieza ORFS

Außengewinde ORFS

Mâle pré-serti ORFS



DN	ROSCA THREAD	Referencia Part n°	€
3/8"	11/16" 16h UN	Z589121106	49,87
1/2"	13/16" 16h UN	Z589121308	60,59
5/8"	1" 14h UNS	Z589121610	90,73
3/4"	1"3/16 12h UN	Z589121912	105,10
1"	1"7/16 12h UN	Z589122316	151,41
1"1/4	1"11/16 12h UN	Z589122720	221,35
1"1/2	2" 12h UN	Z589123224	331,95

One piece ORFS Swivel female (45° Elbow)

Hembras giratorias 45° una sola pieza ORFS

Dichtkopf 45° ORFS einteilig

Coude 45° femelle pré-sertie ORFS



DN	ROSCA THREAD	Referencia Part n°	€
3/8"	11/16" 16h UN	Z589081106	83,06
1/2"	13/16" 16h UN	Z589081308	96,02
5/8"	1" 14h UNS	Z589081610	126,95
3/4"	1"3/16 12h UN	Z589081912	151,31
1"	1"7/16 12h UN	Z589082316	224,77
1"1/4	1"11/16 12h UN	Z589082720	326,81
1"1/2	2" 12h UN	Z589083224	842,27

One piece fittings BWS Series 3SP/4SP/R12/4SH No Skive

Conexiones una sola pieza Serie BWS 3SP/4SP/R12/4SH No Pelar
Einteilige Armaturen Serie BWS 3SP/4SP/R12/4SH ohne Schälung
Embouts pré-sertis Série BWS 3SP/4SP/R12/4SH Sans dénuder

R13 & R15 Ø 3/4" - 1"

One piece double hexagonal NPSM Swivel female 60° cone

Hembras giratorias rectas una sola pieza NPSM (60°) doble hex

Dichtkopf mit NPSM einteilig Ü-Mutter 60° kon. doppelt 6 kt

Femelle pré-sertie NPSM cône 60° double hexagonal



DN	ROSCA THREAD	Referencia Part n°	€
3/8"	3/8" NPSM	Z583610606	43,18
1/2"	1/2" NPSM	Z583610808	50,41
3/4"	3/4" NPSM	Z583611212	74,61
1"	1" NPSM	Z583611616	119,16

One piece NPSM Swivel female 60° cone

Hembras giratorias rectas una sola pieza NPSM cono 60°

Dichtkopf mit NPSM einteilig Ü-Mutter 60° kon.

Femelle pré-sertie NPSM cône 60°



DN	ROSCA THREAD	Referencia Part n°	€
3/8"	3/8" NPSM	Z582610606	32,09
1/2"	1/2" NPSM	Z582610808	41,17
3/4"	3/4" NPSM	Z582611212	60,18
1"	1" NPSM	Z582611616	96,74
1"1/4	1"1/4 NPSM	Z582612020	171,91
1"1/2	1"1/2 NPSM	Z582612424	228,52
2"	2" NPSM	Z582613232	352,58

One piece NPSM Swivel female 60° cone (90° Elbow)

Hembras giratorias 90° una sola pieza rosca NPSM cono 60°

Dichtkopf mit NPSM Ü-Mutter 60° kon. 90° einteilig

Coude 90° femelle pré-sertie NPSM cône 60°



DN	ROSCA THREAD	Referencia Part n°	€
3/8"	3/8" NPSM	Z582620606	45,51
1/2"	1/2" NPSM	Z582620808	59,70
3/4"	3/4" NPSM	Z582621212	87,29
1"	1" NPSM	Z582621616	133,36

One piece NPSM Swivel female 60° cone (45° Elbow)

Hembras giratorias 45° una sola pieza rosca NPSM cono 60°

Dichtkopf mit NPSM Ü-Mutter 60° CON. 45° einteilig kon.

Coude 45° femelle pré-sertie NPSM cône 60°



DN	ROSCA THREAD	Referencia Part n°	€
3/8"	3/8" NPSM	Z582630606	45,51
1/2"	1/2" NPSM	Z582630808	59,70
3/4"	3/4" NPSM	Z582631212	87,30
1"	1" NPSM	Z582631616	133,36

One piece NPT male pipe straight

Machos una sola pieza rosca cónica NPT

Außengewinde einteilig kon. NPT

Mâle pré-serti NPT



DN	ROSCA THREAD	Referencia Part n°	€
3/8"	3/8" NPT	Z581610606	29,65
1/2"	1/2" NPT	Z581610808	36,48
3/4"	3/4" NPT	Z581611212	56,00
1"	1" NPT	Z581611616	92,07
1"1/4	1"1/4 NPT	Z581612020	161,40
1"1/2	1"1/2 NPT	Z581612424	214,13
2"	2" NPT	Z581613232	337,66

One piece NPT swivel male

Machos giratorios una sola pieza rosca cónica NPT

Außengewinde einteilig kon. NPT

Mâle tournant pré-serti NPT



DN	ROSCA THREAD	Referencia Part n°	€
3/8"	3/8" NPT	Z581650606	61,81
1/2"	1/2" NPT	Z581650808	68,21
3/4"	3/4" NPT	Z581651212	98,53
1"	1" NPT	Z581651616	150,26

One piece fittings BWS Series 3SP/4SP/R12/4SH No Skive

Conexiones una sola pieza Serie BWS 3SP/4SP/R12/4SH No Pelar
Einteilige Armaturen Serie BWS 3SP/4SP/R12/4SH ohne Schälung
Embouts pré-sertis Série BWS 3SP/4SP/R12/4SH Sans dénuder

R13 & R15 Ø 3/4" - 1"

One piece 3000 PSI SAE Straight Flange / Code 61

Bridas rectas una sola pieza SAE 3000 PSI

Gerader Kompaktflansch SAE 3000 PSI

Bride SAE droite pré-sertie série 3000 PSI



DN	Ø	Referencia Part n°	€
1/2"	30.2	Z581820808	58,51
5/8"	38.1	Z581821210	86,24
3/4"	38.1	Z581821212	83,81
1"	38.1	Z581821612	110,24
1"	44.5	Z581821616	116,80
1"1/4	50.8	Z581822020	173,22
1"1/2	60.3	Z581822424	240,69
2"	71.4	Z581823232	380,95

One piece 3000 PSI SAE Flange (90° Elbow)/ Code 61

Bridas 90° una sola pieza SAE 3000 PSI

Kompaktflansch 90° SAE 3000 PSI

Bride SAE coude 90° pré-sertie série 3000 PSI



DN	Ø	Referencia Part n°	€
1/2"	30.2	Z581830808	78,16
5/8"	38.1	Z581831210	119,85
3/4"	38.1	Z581831212	111,30
3/4"	44.5	NEW Z581831612	169,66
1"	44.5	Z581831616	154,71
1"1/4	50.8	Z581832020	255,35
1"1/4	60.3	Z581832420	325,37
1"1/2	60.3	Z581832424	345,91
2"	71.4	Z581833232	552,82

One piece 3000 PSI SAE Flange (45° Elbow)/ Code 61

Bridas 45° una sola pieza SAE 3000 PSI

Kompaktflansch 45° SAE 3000 PSI

Bride SAE coude 45° pré-sertie série 3000 PSI



DN	Ø	Referencia Part n°	€
1/2"	30.2	Z581840808	78,16
5/8"	38.1	Z581841210	119,85
3/4"	38.1	Z581841212	111,30
1"	44.5	Z581841616	154,71
1"1/4	50.8	Z581842020	255,35
1"1/2	60.3	Z581842424	345,91
2"	71.4	Z581843232	552,81

One piece 6000 PSI SAE Straight Flange / Code 62

Bridas rectas una sola pieza SAE 6000 PSI

Gerader Kompaktflansch SAE 6000 PSI

Bride SAE droite pré-sertie série 6000 PSI



DN	Ø	Referencia Part n°	€
1/2"	31.8	Z582820808	65,63
5/8"	41.3	Z582821210	109,81
3/4"	41.3	Z582821212	91,83
1"	47.6	Z582821616	127,92
1"	54.0	NEW Z582822016	173,77
1"1/4	54.0	Z582822020	190,06
1"1/2	63.5	Z582822424	302,15
2"	79.4	Z582823232	512,49

One piece 6000 PSI SAE Flange (90° Elbow)/ Code 62

Bridas 90° una sola pieza SAE 6000 PSI

Kompaktflansch 90° SAE 6000 PSI

Bride SAE coude 90° pré-sertie série 6000 PSI



DN	Ø	Referencia Part n°	€
1/2"	31.8	Z582830808	81,72
5/8"	41.3	Z582831210	137,28
3/4"	41.3	Z582831212	125,84
1"	41.3	NEW Z582831612	159,98
1"	47.6	Z582831616	177,37
1"1/4	47.6	NEW Z582832016	221,19
1"1/4	54.0	Z582832020	262,88
1"1/4	63.5	Z582832420	397,16
1"1/2	63.5	Z582832424	442,23
2"	79.4	Z582833232	627,66

One piece 6000 PSI SAE Flange (45° Elbow)/ Code 62

Bridas 45° una sola pieza SAE 6000 PSI

Kompaktflansch 45° SAE 6000 PSI

Bride SAE coude 45° pré-sertie série 6000 PSI



DN	Ø	Referencia Part n°	€
1/2"	31.8	Z582840808	81,72
5/8"	41.3	Z582841210	137,28
3/4"	41.3	Z582841212	125,84
1"	47.6	Z582841616	177,37
1"1/4	54.0	Z582842020	262,88
1"1/2	63.5	Z582842424	442,23
2"	79.4	Z582843232	627,66

One piece fittings BWS Series 3SP/4SP/R12/4SH No Skive

Conexiones una sola pieza Serie BWS 3SP/4SP/R12/4SH No Pelar
Einteilige Armaturen Serie BWS 3SP/4SP/R12/4SH ohne Schälung
Emboutis pré-sertis Série BWS 3SP/4SP/R12/4SH Sans dénuder

R13 & R15 Ø 3/4" - 1"

One piece Metric female cone 24°

Hembras gir rectas una sola pieza rosca Métrica
cono 24° - DKO

Dichtkopf metr. einteilig Ü-Mutter kon. 24°

Femelle pré-sertie Métrique cône 24°



DN	TUBO PIPE	SERIE SERIES	ROSCA THREAD	Referencia Part n°	€
3/8"	10	L	M16x1.5	Z58804161006	31,35
3/8"	12	L	M18x1.5	Z58804181206	30,16
3/8"	15	L	M22x1.5	Z58804221506	36,02
1/2"	15	L	M22x1.5	Z58804221508	37,37
1/2"	18	L	M26x1.5	Z58804261808	46,90
3/4"	18	L	M26x1.5	Z58804261812	73,38
5/8"	18	L	M26x1.5	Z58804261810	54,70
3/4"	22	L	M30x2	Z58804302212	59,46
1"	28	L	M36x2	Z58804362816	95,76
1"1/4	35	L	M45x2	Z58804453520	145,93
1"1/2	42	L	M52x2	Z58804524224	220,96
3/8"	12	S	M20x1.5	Z58804201206	33,15
1/2"	16	S	M24x1.5	Z58804241608	37,55
5/8"	20	S	M30x2	Z58804302010	58,01
3/4"	20	S	M30x2	Z58804302012	67,38
5/8"	25	S	M36x2	NEW Z58804362510	85,72
3/4"	25	S	M36x2	Z58804362512	80,60
1"	25	S	M36x2	NEW Z58804362516	112,88
1"	30	S	M42x2	Z58804423016	116,07
1"1/4	38	S	M45x2	Z58804523820	193,83

One piece Metric male cone 24°

Machos una sola pieza rosca Métrica cono 24°

Außengewinde einteilig metr. kon. 24°

Mâle pré-serti Métrique cône 24°



DN	TUBO PIPE	SERIE	ROSCA THREAD	Referencia Part n°	€
3/8"	10	L	M16x1.5	Z58203161006	35,02
3/8"	12	L	M18x1.5	Z58203181206	28,49
3/8"	15	L	M22x1.5	Z58203221506	41,88
1/2"	15	L	M22x1.5	Z58203221508	37,42
1/2"	18	L	M26x1.5	Z58203261808	49,13
5/8"	18	L	M26x1.5	Z58203261810	54,13
3/4"	22	L	M30x2	Z58203302212	65,35
1"	28	L	M36x2	Z58203362816	101,50
1"1/4	35	L	M45x2	Z58203453520	170,66
1"1/2	42	L	M52x2	Z58203524224	258,03
3/8"	12	S	M20x1.5	Z58203201206	37,68
1/2"	16	S	M24x1.5	Z58203241608	40,66
5/8"	20	S	M30x2	Z58203302010	64,36
3/4"	20	S	M30x2	Z58203302012	73,89
3/4"	25	S	M36x2	Z58203362512	89,07
1"	30	S	M42x2	Z58203423016	141,83
1"1/4	38	S	M45x2	Z58203523820	223,21

One piece Metric female cone 24° (45° Elbow)

Hembras gir 45° una sola pieza Métricas cono 24°
- DKO 45°

Dichtkegel mit Ü-Mutter 45° Bogen einteilig

Coude 45° femelle pré-sertie Métrique cône 24°



One piece Metric female cone 24° (90° Elbow)

Hembras gir 90° una sola pieza Métricas cono 24°
- DKO 90°

Dichtkegel mit Ü-Mutter 90° Bogen einteilig

Coude 90° femelle pré-sertie Métrique cône 24°



DN	TUBO PIPE	ROSCA THREAD	SERIE SERIES	Referencia Part n°	€
3/8"	10	M16x1.5	L	Z58305161006	42,52
3/8"	12	M18x1.5	L	Z58305181206	40,53
1/2"	15	M22x1.5	L	Z58305221508	49,15
5/8"	18	M26x1.5	L	Z58305261810	72,67
3/4"	22	M30x2	L	Z58305302212	86,36
1"	28	M36x2	L	Z58305362816	133,15
1"1/4	35	M45x2	L	Z58305453520	220,57
1"1/2	42	M52x2	L	Z58305524224	344,07
3/8"	12	M20x1.5	S	Z58305201206	45,55
1/2"	16	M24x1.5	S	Z58305241608	51,87
5/8"	20	M30x2	S	Z58305302010	82,09
3/4"	20	M30x2	S	Z58305302012	89,64
3/4"	25	M36x2	S	Z58305362512	114,40
1"	25	M36x2	S	NEW Z58305362516	150,62
1"	30	M42x2	S	Z58305423016	173,47
1"1/4	38	M52x2	S	Z58305523820	293,72

DN	TUBO PIPE	SERIE	ROSCA THREAD	Referencia Part n°	€
3/8"	10	L	M16x1.5	Z58306161006	42,52
3/8"	12	L	M18x1.5	Z58306181206	40,53
1/2"	15	L	M22x1.5	Z58306221508	49,15
5/8"	18	L	M26x1.5	Z58306261810	72,68
3/4"	22	L	M30x2	Z58306302212	86,36
1"	28	L	M36x2	Z58306362816	133,15
1"1/4	35	L	M45x2	Z58306453520	220,57
1"1/2	42	L	M52x2	Z58306524224	344,07
3/8"	12	S	M20x1.5	Z58306201206	45,55
1/2"	16	S	M24x1.5	Z58306241608	51,87
5/8"	20	S	M30x2	Z58306302010	82,09
3/4"	20	S	M30x2	Z58306302012	89,64
3/4"	25	S	M36x2	Z58306362512	114,40
1"	25	S	M36x2	NEW Z58306362516	150,62
1"	30	S	M42x2	Z58306423016	173,47
1"1/4	38	S	M52x2	Z58306523820	293,72

One piece fittings BWS Series 3SP/4SP/R12/4SH No Skive

Conexiones una sola pieza Serie BWS 3SP/4SP/R12/4SH No Pelar
Einteilige Armaturen Serie BWS 3SP/4SP/R12/4SH ohne Schälung
Embouts pré-sertis Série BWS 3SP/4SP/R12/4SH Sans dénuder

👁️ R13 & R15 Ø 3/4" - 1"

One piece double hexagonal BSP female 60° cone

Hembras giratoias rectas una sola pieza BSP (60°) doble hex
Dichtkopf mit Ü-Mutter einteilig BSP 60° kon.
doppelt 6 kt

Femelle pré-sertie BSP cône 60° double hexagonal



DN	ROSCA THREAD	Referencia Part n°	€
3/8"	3/8" BSP	Z584000606	39,30
1/2"	1/2" BSP	Z584000808	42,19
3/4"	3/4" BSP	Z584001212	73,30
1"	1" BSP	Z584001616	106,60
1"1/4	1"1/4 BSP	Z584002020	166,41
1"1/2	1"1/2 BSP	Z584002424	257,50
2"	2" BSP	Z584003232	416,00

One piece BSP female cone 60° w/o ring (90° Elbow)

Hembras giratorias 90° una sola pieza BSP C/J
cono 60°

Dichtkopf BSP Ü-Mutter einteilig 60° mit
O'Ringkon. 90°

Coude 90° femelle pré-sertie BSP cône 60° avec
joint



DN	ROSCA THREAD	Referencia Part n°	€
3/8"	3/8" BSP	Z581170606	47,56
1/2"	1/2" BSP	Z581170808	54,11
3/4"	3/4" BSP	Z581171212	81,31
1"	1" BSP	Z581171616	136,99
1"1/4	1"1/4 BSP	Z581172020	246,24
1"1/2	1"1/2 BSP	Z581172424	350,46
2"	2" BSP	Z581173232	629,48

One piece BSP male 60° cone

Machos una sola pieza rosca cilíndrica BSP cono
60°

Außengewinde zyl. einteilig kon. BSP 60°

Mâle pré-serti BSP cône 60°



DN	ROSCA THREAD	Referencia Part n°	€
3/8"	3/8" BSP	Z581120606	31,17
1/2"	1/2" BSP	Z581120808	38,67
5/8"	5/8" BSP	Z581121010	68,21
3/4"	3/4" BSP	Z581121212	57,08
1"	1" BSP	Z581121616	103,32
1"1/4	1" BSP	Z581122016	151,13
1"1/4	1"1/4 BSP	Z581122020	175,70
1"1/2	1"1/2 BSP	Z581122424	231,26
2"	2" BSP	Z581123232	357,89

One piece BSP female flat seat

Hembras giratorias rectas una sola pieza BSP
asiento plano

Dichtkopf mit Ü-Mutter einteilig BSP flachdichtend

Femelle pré-sertie BSP fond plat



DN	ROSCA THREAD	Referencia Part n°	€
3/8"	3/8" BSP	Z582000606	30,62
1/2"	1/2" BSP	Z582000808	37,03
3/4"	3/4" BSP	Z582001212	55,43
1"	1" BSP	Z582001616	90,84
1"1/4	1"1/4 BSP	Z582002020	144,73
1"1/2	1"1/2 BSP	Z582002424	206,04
2"	2" BSP	Z582003232	330,49

One piece BSP female cone 60° w/o ring (45° Elbow)

Hembras giratorias 45° una sola pieza BSP C/J
cono 60°

Dichtkopf mit BSP Ü-Mutter 60° mit O'Ring
einteilig 45° kon.

Coude 45° femelle pré-sertie BSP cône 60° avec
joint



DN	ROSCA THREAD	Referencia Part n°	€
3/8"	3/8" BSP	Z581180606	47,56
1/2"	1/2" BSP	Z581180808	54,10
3/4"	3/4" BSP	Z581181212	81,30
1"	1" BSP	Z581181616	136,99
1"1/4	1"1/4 BSP	Z581182020	246,25
1"1/2	1"1/2 BSP	Z581182424	350,46
2"	2" BSP	Z581183232	629,48

One piece BSP female 60° cone 60° w/o ring

Hembras giratorias rectas una sola pieza BSP C/J
cono 60°

Dichtkopf mit Ü-Mutter einteilig BSP 60° mit
O'Ring kon.

Femelle pré-sertie BSP cône 60° avec joint



DN MANGUERA DN HOSE	ROSCA THREAD	Referencia Part n°	€
3/8"	3/8" BSP	Z581100606	32,24
1/2"	1/2" BSP	Z581100808	36,97
3/4"	3/4" BSP	Z581101212	53,62
1"	1" BSP	Z581101616	93,60
1"1/4	1"1/4 BSP	Z581102020	158,10
1"1/2	1"1/2 BSP	Z581102424	214,34
2"	2" BSP	Z581103232	371,53

BWS

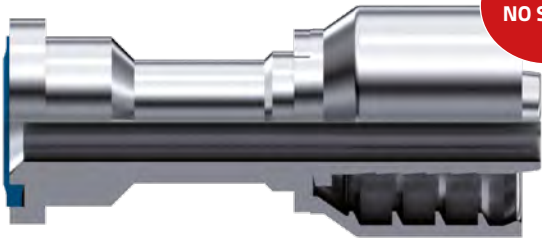

NO PELAR
NO SKIVE

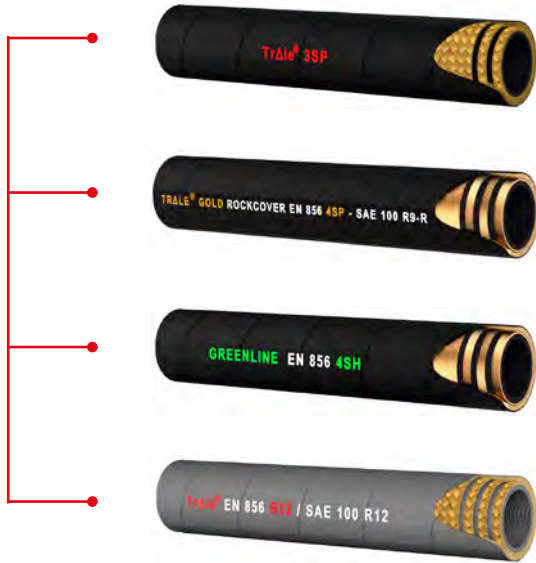

MAYOR VERSATILIDAD. 1 CASQUILLO - 4 MANGUERAS
GREATER VERSATILITY. 1 FERRULE - 4 HOSES

+



REDUCCIÓN DE STOCK. USO DE ESPIGA STD
STOCK OPTIMISATION. STD SERIES

+



MENOR TIEMPO DE MONTAJE. NO PELAR
REDUCES ASSEMBLY TIME. NO SKIVE

=



AHORRO ECONÓMICO.
ECONOMIC EFFICIENCY

BW+



NO PELAR
NO SKIVE



ALTA PRESIÓN
HIGH PRESSURE

1" 1/4 - 1" 1/2-2

R13 - R15

+



REDUCCIÓN DE STOCK. USO DE ESPIGA BW
STOCK OPTIMISATION. BW SERIES

+



MENOR TIEMPO DE MONTAJE. NO PELAR
REDUCES ASSEMBLY TIME. NO SKIVE

One piece fittings BW+ Series R13/R15 No Skive

Conexiones una pieza Serie BW+ R13/R15 No Pelar

Armaturen Serie BW+ R13/R15 ohne Schälung

Embouts R13/R15 Série BW+ Sans denuder

R13 & R15 Ø 3/4" - 1" ->> BWS

One piece double hexagonal JIC 37° Swivel female

Hembras giratorias rectas una sola pieza JIC 37°
doble hexagonal

Dichtkopf mit Ü-Mutter einteilig 37° JIC doppelt 6 kt

Femelle pré-sertie JIC 37° double hexagonal



DN	ROSCA THREAD	Referencia Part n°	€
1"1/4	1"5/8 12 UN	Z692422620	286,02
1"1/2	1"7/8 12 UN	Z692423024	396,55
2"	2" 1/2 12 UN	Z692424032	611,48

One piece JIC 37° Swivel female (90° Elbow)

Hembras giratorias 90° una sola pieza rosca JIC 37°

Dichtkopf mit Ü-Mutter einteilig 37° JIC 90°

Coude 90° femelle pré-sertie JIC 37°



DN	ROSCA THREAD	Referencia Part n°	€
1"1/4	1"5/8 12 UN	Z691382620	243,80
1"1/2	1"7/8 12 UN	Z691383024	304,17
2"	2" 1/2 12 UN	Z691384032	578,35

One piece JIC 37° male with o'ring

Machos una sola pieza rosca JIC 37° C/J

Außengewinde einteilig JIC 37° mit O-Ring

Mâle pré-serti JIC 37° avec joint torique



DN	ROSCA THREAD	Referencia Part n°	€
1"1/4	1"5/8 12 UN	Z691412620	196,13
1"1/2	1"7/8 12 UN	Z691413024	220,26
2"	2" 1/2 12 UN	Z691414032	421,75

One piece JIC 37° Swivel female (45° Elbow)

Hembras giratorias 45° una sola pieza rosca JIC 37°

Dichtkonus JIC 37° einteilig 45°

Coude 45° femelle pré-sertie JIC 37°



DN	ROSCA THREAD	Referencia Part n°	€
1"1/4	1"5/8 12 UN	Z691392620	242,58
1"1/2	1"7/8 12 UN	Z691393024	304,17
2"	2" 1/2 12 UN	Z691394032	578,35

One piece ORFS Swivel female straight double hexagonal

Hembras giratorias rectas una sola pieza ORFS
doble hexagonal

Dichtkopf mit ORFS einteilig Ü-Mutter doppelt 6 kt

Femelle pré-sertie droite ORFS double hexagonale



DN	ROSCA THREAD	Referencia Part n°	€
1"1/4	1" 11/16 12 UN	Z699012720	250,69
1"1/2	2" 12 UN	Z699013224	316,70

One piece ORFS Swivel female (90° Elbow)

Hembras giratorias 90° una sola pieza ORFS

Dichtkopf mit ORFS einteilig Ü-Mutter 90°

Coude 90° femelle pré-sertie ORFS



DN	ROSCA THREAD	Referencia Part n°	€
1"1/4	1" 11/16 12 UN	Z699072720	456,58
1" 1/2	2" 12 UN	Z699073224	1.156,72

One piece ORFS Swivel female (45° Elbow)

Hembras giratorias 45° una sola pieza ORFS

Dichtkopf mit ORFS einteilig Ü-Mutter 45°

Coude 45° femelle pré-sertie ORFS



DN	ROSCA THREAD	Referencia Part n°	€
1"1/4	1"11/16 12 UN	Z699082720	456,58
1"1/2	2" 12 UN	Z699083224	1.156,72

One piece ORFS Male

Machos una sola pieza ORFS

Außengewinde ORFS einteilig

Mâle pré-serti ORFS



DN	ROSCA THREAD	Referencia Part n°	€
1"1/4	1"11/16 12 UN	Z699122720	366,22
1"1/2	2" 12 UN	Z699123224	508,81

One piece fittings BW+ Series R13/R15 No Skive

Conexiones una pieza Serie BW+ R13/R15 No Pelar

Armaturen Serie BW+ R13/R15 ohne Schälung

Embouts R13/R15 Série BW+ Sans denuder

R13 & R15 Ø 3/4" - 1" ->> BWS

One piece double hexagonal NPSM female 60° cone

Hembras gir rectas una sola pieza rosca NPSM (60°) doble hex

Dichtkopf mit NPSM einteilig Überwurfmutter 60° kon. doppelt hexagonal

Femelle pré-sertie NPSM cône 60° double hexagonal



DN	ROSCA THREAD	Referencia Part n°	€
1"1/4	1"1/4 - 11 1/2 h NPSM	Z693612020	276,47
1"1/2	1"1/2 - 11 1/2 h NPSM	Z693612424	351,30
2"	2" - 11 1/2 h NPSM	Z693613232	580,70

One piece NPT Male pipe straight

Machos una sola pieza rosca cónica NPT

Außengewinde kon. einteilig NPT

Mâle pré-serti conique NPT



DN	ROSCA THREAD	Referencia Part n°	€
1"1/4	1"1/4 - 11 1/2 h NPSM	Z691612020	192,98
1"1/2	1"1/2 - 11 1/2 h NPSM	Z691612424	247,41
2"	2" - 11 1/2 h NPSM	Z691613232	451,57

One piece 6000 PSI SAE Straight Flange / Code 62

Bridas recta SAE 6000 PSI

Gerader Kompaktflansch SAE 6000 PSI

Bride SAE droite pré-sertie série 6000 PSI



DN	Ø	Referencia Part n°	€
1"1/4	1"1/4	Z692822020	231,41
1"1/2	1"1/2	Z692822424	309,59
2"	2"	Z692823232	470,26

One piece 6000 PSI SAE Flange (90° Elbow) / Code 62

Bridas a 90° SAE 6000 PSI

Kompaktflansch 90° SAE 6000 PSI

Bride SAE coude 90° pré-sertie série 6000 PSI



DN	Ø	Referencia Part n°	€
1"1/4	1"1/4	Z692832020	275,59
1"1/2	1"1/2	Z692832424	381,74
2"	2"	Z692833232	599,58

One piece 6000 PSI SAE Flange (45° Elbow) / Code 62

Bridas a 45° SAE 6000 PSI

Kompaktflansch 45° SAE 6000 PSI

Bride SAE coude 45° pré-sertie série 6000 PSI



DN	Ø	Referencia Part n°	€
1"1/4	1"1/4	Z692842020	275,60
1"1/2	1"1/2	Z692842424	381,74
2"	2"	Z692843232	599,58

One piece fittings BW+ Series R13/R15 No Skive

Conexiones una pieza Serie BW+ R13/R15 No Pelar

Armaturen Serie BW+ R13/R15 ohne Schälung

Embouts R13/R15 Série BW+ Sans denuder

R13 & R15 Ø 3/4" - 1" ->>BWS

One piece double hexagonal BSP Swivel female cone 60° with o'ring wire nut

Hembras giratorias una pieza BSP 60° doble hex c/j tca eng.

Dichtkopf einteilig 60° kon. doppelt hexagonal mit O-Ring Muffenmutter

Femelle BSP pré-sertie cône 60° double hexagonal with o'ring écrou à douille



DN	ROSCA THREAD	Referencia Part n°	€
1"1/4	1"1/4 BSP	Z695102020	221,75
1"1/2	1"1/2 BSP	Z695102424	309,85
2"	2" BSP	Z695103232	514,70

One piece BSP Male 60° cone

Machos cilíndricos una sola pieza BSP 60°

Außengewinde zyl. einteilig BSP 60°

Mâle pré-serti gaz cylindrique BSP 60°



DN	ROSCA THREAD	Referencia Part n°	€
1"1/4	1"1/4 BSP	Z691122020	199,84
1"1/2	1"1/2 BSP	Z691122424	250,50
2"	2" BSP	Z691123232	447,20

One piece BSP Swivel female 60° cone with o'ring (90° Elbow) wire nut

Hembras giratorias 90° una sola pieza BSP 60° c/j tca eng.

Dichtkopf mit BSP Ü-Mutter 60° einteilig 90° mit O-Ring Muffenmutter

Coude 90° femelle pré-sertie BSP 60° avec o'ring écrou à douille



DN	ROSCA THREAD	Referencia Part n°	€
1"1/4	1"1/4 BSP	Z695172020	258,54
1"1/2	1"1/2 BSP	Z695172424	335,59
2"	2" BSP	Z695173232	586,87

One piece BSP Swivel female 60° cone with o'ring (45° Elbow) wire nut

Hembras giratorias 45° una sola pieza BSP 60° c/j tca eng.

Dichtkopf mit BSP Ü-Mutter 60° einteilig 45° mit O-Ring Muffenmutter

Coude 45° femelle pré-sertie BSP 60° avec o'ring écrou à douille



DN	ROSCA THREAD	Referencia Part n°	€
1"1/4	1"1/4 BSP	Z695182020	258,54
1"1/2	1"1/2 BSP	Z695182424	335,59
2"	2" BSP	Z695183232	586,87

BAJO CONSULTA
UNDER REQUEST

BW+ MÉTRICAS / METRIC BW+

■ Hembras giratorias rectas una sola pieza rosca Métrica cono 24° con junta tórica

One piece Metric swivel female 24° seat with o'ring

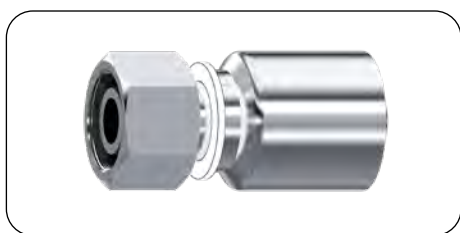

Ref: Z69204

■ Hembras giratorias 90° una sola pieza Métricas cono 24° con junta tórica

One piece Metric swivel female 24° seat with o'ring



Ref: Z69205

■ Macho una sola pieza Métricos cono 24°

One piece Metric male stud 24° cone

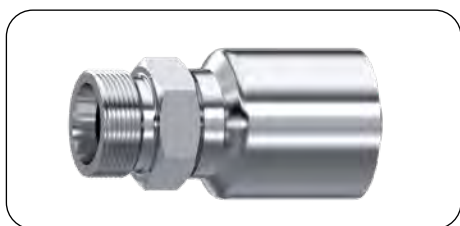

Ref: Z69203

■ Hembras giratorias 45° una sola pieza Métricas cono 24° con junta tórica

One piece Metric swivel female 24° seat with o'ring

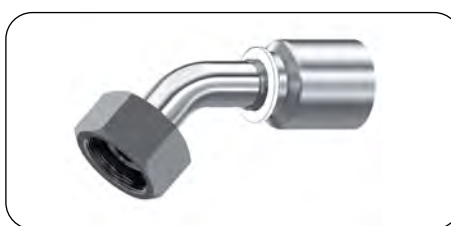

Ref: Z69206

One piece fittings R7/R8 & Elastomer Braid of steel wire

Conexiones una sola pieza R7/ R8/ Elastómero malla metálica

Einteilige Armaturen R7/ R8 und Elastomer/Metallumfl.

Embouts pré-sertis R7/R8 et Elastomère tresse métallique

One piece double hexagonal JIC 37° female

Hembras giratorias rectas una sola pieza rosca JIC 37° doble hex

Dichtkopf einteilig Ü-Mutter 37° JIC doppelt 6 kt

Femelle pré-sertie JIC 37° double hexagonal



DN	ROSCA THREAD	Referencia Part n°	€
3/16"	7/16" 20h UNF	872420703	27,12
1/4"	7/16" 20h UNF	872420704	23,41
5/16"	7/16" 20h UNF	872420705	34,33
1/4"	9/16" 18h UNF	872420904	31,12
5/16"	9/16" 18h UNF	872420905	34,74
3/8"	9/16" 18h UNF	872420906	27,75
1/2"	3/4" 16h UNF	872421208	31,68
1/2"	7/8" 14h UNF	872421408	41,60
5/8"	1"1/16 12h UN	872421710	56,95
3/4"	1"1/16 12h UN	872421712	51,06
1"	1"5/16 12h UN	872422116	81,29

One piece JIC 37° female (90° Elbow)

Hembras giratorias 90° una sola pieza rosca JIC 37°

Dichtkopf einteilig Ü-Mutter 37° JIC 90°

90° Femelle pré-sertie JIC 37°



DN	ROSCA THREAD	Referencia Part n°	€
3/16"	7/16" 20h UNF	871380703	33,39
1/4"	7/16" 20h UNF	871380704	27,83
1/4"	9/16" 18h UNF	871380904	41,06
3/8"	9/16" 18h UNF	871380906	34,43
1/2"	3/4" 16h UNF	871381208	40,29
1/2"	7/8" 14h UNF	NEW 871381408	42,72
3/4"	1"1/16 12h UN	871381712	67,50
1"	1"5/16 12h UN	871382116	107,91

One piece JIC 37° male

Machos una sola pieza rosca JIC 37°

Außengewinde einteilig JIC 37°

Mâle pré-serti JIC 37°



DN	ROSCA THREAD	Referencia Part n°	€
3/16"	7/16" 20h UNF	NEW 871400703	29,43
1/4"	7/16" 20h UNF	871400704	25,30
3/8"	9/16" 18h UNF	871400906	33,57
1/2"	3/4" 16h UNF	871401208	33,00
3/4"	1"1/16 12h UN	871401712	53,20
1"	1"5/16 12h UN	871402116	83,30

One piece JIC 37° female

Hembras giratorias rectas una sola pieza rosca JIC 37°

Dichtkopf einteilig Ü-Mutter 37° JIC

Femelle pré-sertie JIC 37°



DN	ROSCA THREAD	Referencia Part n°	€
3/16"	7/16" 20h UNF	871420703	20,31
1/4"	7/16" 20h UNF	871420704	20,55
1/4"	9/16" 18h UNF	871420904	23,48
5/16"	9/16" 18h UNF	871420905	23,52
3/8"	9/16" 18h UNF	871420906	23,92
1/2"	3/4" 16h UNF	871421208	28,83
1/2"	7/8" 14h UNF	871421408	30,33
3/4"	1"1/16 12h UN	871421712	43,03
1"	1"5/16 12h UN	871422116	69,58

One piece JIC 37° female (45° Elbow)

Hembras giratorias 45° una sola pieza rosca JIC 37°

Dichtkopf einteilig Ü-Mutter 37° JIC 45°

45° Femelle pré-sertie JIC 37°



DN	ROSCA THREAD	Referencia Part n°	€
1/4"	7/16" 20h UNF	871390704	27,83
3/8"	9/16" 18h UNF	871390906	34,43
1/2"	3/4" 16h UNF	871391208	40,29
3/4"	1"1/16 12h UN	871391712	67,51
1"	1"5/16 12h UN	871392116	107,91

One piece fittings R7/R8 & Elastomer Braid of steel wire

Conexiones una sola pieza R7/ R8/ Elastómero malla metálica
Einteilige Armaturen R7/ R8 und Elastomer/Metallumfl.
Embouts pré-sertis R7/R8 et Elastomère tresse métallique

One piece double hexagonal ORFS female

Hembras giratorias rectas una sola pieza rosca ORFS doble hex

Dichtkopf mit ORFS einteilig Ü-Mutter doppelt 6 kt

Femelle pré-sertie ORFS double hexagonal



DN	ROSCA THREAD	Referencia Part n°	€
1/4"	9/16"-18h	879000904	36,66
3/8"	11/16"-16h	879001106	41,90
3/8"	13/16"-16h	879001306	50,59
1/2"	13/16"-16h	879001308	47,33
3/4"	1"3/16-12h	879001912	73,98
1"	1"7/16-12h	879002316	126,01

One piece ORFS female (90° Elbow)

Hembras giratorias 90° una sola pieza rosca ORFS

Dichtkopf mit ORFS einteilig Ü-Mutter 90°

90° Femelle pré-sertie ORFS



DN	ROSCA THREAD	Referencia Part n°	€
1/4"	9/16"-18h	879070904	61,04
3/8"	11/16"-16h	879071106	73,39
1/2"	13/16"-16h	879071308	84,70
3/4"	1"3/16-12h	879071912	133,47
1"	1"7/16-12h	879072316	197,85

One piece ORFS male

Machos compactos rosca ORFS

Außengewinde einteilig ORFS

Mâle pré-serti ORFS



DN	ROSCA THREAD	Referencia Part n°	€
1/4"	9/16"-18h	879120904	42,44
3/8"	11/16"-16h	879121106	42,66
1/2"	13/16"-16h	879121308	51,89
3/4"	1"3/16-12h	879121912	90,69
1"	1"7/16-12h	879122316	129,91

One piece ORFS female (45° Elbow)

Hembras giratorias 45° una sola pieza rosca ORFS

Dichtkopf 45° ORFS einteilig

45° Femelle pré-sertie ORFS



DN	ROSCA THREAD	Referencia Part n°	€
1/4"	9/16"-18h	879080904	61,04
3/8"	11/16"-16h	879081106	73,39
1/2"	13/16"-16h	879081308	84,70
3/4"	1"3/16-12h	879081912	133,47
1"	1"7/16-12h	879082316	197,84

Configura tus propias conexiones en Una sola pieza (43/R7/R8/PTFE/BWS). Consúltanos

Configure your own One piece series fittings (43/R7/R8/PTFE/BWS). Consult us.



UNA SOLA PIEZA / ONE PIECE



CASQUILLOS / FERRULES



CONEXIONES / FITTINGS

COMBINACIONES INFINITAS CONSÚLTANOS!

ENDLESS FITTINGS OPTIONS. FIND THEM OUT!



One piece fittings R7/R8 & Elastomer Braid of steel wire

Conexiones una sola pieza R7/ R8/ Elastómero malla metálica

Einteilige Armaturen R7/ R8 und Elastomer/Metallumfl.

Embouts pré-sertis R7/R8 et Elastomère tresse métallique

One piece double hexagonal NPSM female 60° cone

Hembras giratorias rectas una sola pieza NPSM (60°) doble hex

Dichtkopf mit NPSM einteilig Ü-Mutter 60° kon. doppelt 6 kt

Femelle pré-sertie NPSM cône 60° double hexagonal



One piece NPSM female 60° cone

Hembras giratorias rectas una sola pieza NPSM cono 60°

Dichtkopf mit NPSM einteilig Ü-Mutter 60° kon.

Femelle pré-sertie NPSM cône 60°



DN	ROSCA THREAD	Referencia Part n°	€
1/4"	1/4" NPSM	873610404	33,74
3/8"	3/8" 18h NPSM	873610606	36,47
1/2"	1/2" 14h NPSM	873610808	42,46
3/4"	3/4" NPSM	873611212	62,45
1"	1" - 11 1/2 h NPSM	873611616	100,06

DN	ROSCA THREAD	Referencia Part n°	€
1/4"	1/4" 18h NPSM	872610404	23,49
3/8"	3/8" 18h NPSM	872610606	26,20
1/2"	1/2" 14h NPSM	872610808	33,92
3/4"	3/4" 14h NPSM	872611212	49,09
1"	1" - 11 1/2 h NPSM	872611616	79,29

One piece NPSM female 60° cone (90° Elbow)

Hembras giratorias 90° una sola pieza NPSM cono 60°

Dichtkopf mit NPSM einteilig Ü-Mutter 60° kon. 90°

90° Femelle pré-sertie NPSM cône 60°



One piece NPSM female 60° cone (45° Elbow)

Hembras giratorias 45° una sola pieza NPSM cono 60°

Dichtkopf mit NPSM Ü-Mutter 60° kon. 45° einteilig

45° Femelle pré-sertie NPSM cône 60°



DN	ROSCA THREAD	Referencia Part n°	€
1/4"	1/4" 18h NPSM	872620404	32,82
3/8"	3/8" 18h NPSM	872620606	38,63
1/2"	1/2" 14h NPSM	872620808	51,07
3/4"	3/4" 14h NPSM	872621212	74,20
1"	1" - 11 1/2 h NPSM	872621616	113,20

DN	ROSCA THREAD	Referencia Part n°	€
1/4"	1/4" 18h NPSM	872630404	32,82
3/8"	3/8" 18h NPSM	872630606	38,63
1/2"	1/2" 14h NPSM	872630808	51,07
3/4"	3/4" 14h NPSM	872631212	74,20
1"	1" - 11 1/2 h NPSM	872631616	113,20

One piece NPT male pipe straight

Machos una sola pieza rosca cónica NPT

Außengewinde einteilig kon. NPT

Mâle pré-serti NPT



DN	ROSCA THREAD		Referencia Part n°	€
1/4"	1/8" NPT	NEW	871610204	26,22
3/16"	1/4" NPT		871610403	26,39
1/4"	1/4" NPT		871610404	20,49
3/8"	1/4" NPT		871610406	30,35
1/4"	3/8" NPT		871610604	28,19
3/8"	3/8" NPT		871610606	23,94
1/2"	1/2" NPT		871610808	29,57
3/4"	1/2" NPT	NEW	871610812	50,21
3/4"	3/4" NPT		871611212	45,23
1"	1" NPT		871611616	74,97

One piece fittings R7/R8 & Elastomer Braid of steel wire

Conexiones una sola pieza R7/ R8/ Elastómero malla metálica
Einteilige Armaturen R7/ R8 und Elastomer/Metallumfl.
Embouts pré-sertis R7/R8 et Elastomère tresse métallique

One piece Metric female 24° cone

Hembras gir rectas una sola pieza rosca Métrica cono 24° - DKO

Dichtkopf metr. einteilig Ü-Mutter kon. 24°

Femelle pré-sertie Métrique cône 24°



DN	TUBO PIPE	SERIE SERIES	ROSCA THREAD	Referencia Part n°	€
3/16"	6	L	M12x1.5	87804120603	21,38
1/4"	6	L	M12x1.5	87804120604	21,02
1/4"	8	L	M14x1.5	87804140804	19,85
3/8"	10	L	M16x1.5	87804161006	25,51
3/8"	12	L	M18x1.5	87804181206	24,41
1/2"	15	L	M22x1.5	87804221508	30,40
3/4"	22	L	M30x2	87804302212	48,42
1"	28	L	M36x2	87804362816	78,39
1/4"	8	S	M16x1.5	87804160804	21,56
1/4"	10	S	M18x1.5	87804181004	23,71
3/8"	12	S	M20x1.5	87804201206	27,18
1/2"	16	S	M24x1.5	87804241608	30,56
3/4"	20	S	M30x2	87804302012	55,76
3/4"	25	S	M36x2	87804362512	68,00
1"	30	S	M42x2	87804423016	97,19

One piece Metric female 24° cone (90° Elbow)

Hembras gir 90° una sola pieza Métricas cono 24° - DKO 90°

Dichtkegel mit Ü-Mutter 90° Bogen einteilig

90° Femelle pré-sertie Métrique cône 24°



DN	TUBO PIPE	SERIE SERIES	ROSCA THREAD	Referencia Part n°	€
1/4"	8	L	M14x1.5	87305140804	28,29
3/8"	10	L	M16x1.5	87305161006	35,86
3/8"	12	L	M18x1.5	87305181206	34,01
1/2"	15	L	M22x1.5	87305221508	41,30
3/4"	22	L	M30x2	87305302212	73,34
1"	28	L	M36x2	87305362816	113,00
1/4"	8	S	M16x1.5	87305160804	32,41
1/4"	10	S	M18x1.5	87305181004	32,92
3/8"	12	S	M20x1.5	87305201206	38,66
1/2"	16	S	M24x1.5	87305241608	43,82
3/4"	25	S	M36x2	87305362512	99,30
1"	30	S	M42x2	87305423016	150,34

One piece Metric male 24° cone

Machos una sola pieza rosca Métrica cono 24°

Außengewinde einteilig metr. kon. 24°

Mâle pré-serti Métrique cône 24°



DN	TUBO PIPE	SERIE SERIES	ROSCA THREAD	Referencia Part n°	€
1/4"	8	L	M14x1.5	87203140804	23,45
3/8"	12	L	M18x1.5	87203181206	22,87
1/2"	15	L	M22x1.5	87203221508	30,44
3/4"	22	L	M30x2	87203302212	53,88
1"	28	L	M36x2	87203362816	83,70
1/4"	8	S	M16x1.5	87203160804	29,13
1/4"	10	S	M18x1.5	87203181004	31,68
3/8"	12	S	M20x1.5	87203201206	31,37
1/2"	16	S	M24x1.5	87203241608	33,44
3/4"	25	S	M36x2	87203362512	75,84
1"	30	S	M42x2	87203423016	121,04

One piece Metric female 24° cone (45° Elbow)

Hembras gir 45° una sola pieza Métricas cono 24° - DKO 45°

Dichtkegel mit Ü-Mutter 45° Bogen einteilig

45° Femelle pré-sertie Métrique cône 24°



DN	TUBO PIPE	SERIE SERIES	ROSCA THREAD	Referencia Part n°	€
1/4"	8	L	M14x1.5	87306140804	28,29
3/8"	10	L	M16x1.5	87306161006	35,86
3/8"	12	L	M18x1.5	87306181206	34,01
1/2"	15	L	M22x1.5	87306221508	41,30
3/4"	22	L	M30x2	87306302212	73,34
1"	28	L	M36x2	87306362816	113,00
1/4"	8	S	M16x1.5	87306160804	32,41
1/4"	10	S	M18x1.5	87306181004	32,92
3/8"	12	S	M20x1.5	87306201206	38,66
1/2"	16	S	M24x1.5	87306241608	43,82
3/4"	25	S	M36x2	87306362512	99,30
1"	30	S	M42x2	87306423016	150,34

One piece fittings R7/R8 & Elastomer Braid of steel wire

Conexiones una sola pieza R7/ R8/ Elastómero malla metálica

Einteilige Armaturen R7/ R8 und Elastomer/Metallumfl.

Embouts pré-sertis R7/R8 et Elastomère tresse métallique

One piece double hexagonal BSP female 60° cone

Hembras giratorias rectas una sola pieza BSP (60°) doble hex

Dichtkopf mit Ü-Mutter einteilig BSP 60° kon. doppelt 6 kt

Femelle pré-sertie BSP cône 60° double hexagonal



DN	ROSCA THREAD	Referencia Part n°	€
1/4"	1/4" BSP	874000404	28,78
3/8"	3/8" BSP	874000606	32,88
1/2"	1/2" BSP	874000808	34,86
3/4"	3/4" BSP	874001212	61,24
1"	1" BSP	874001616	88,43

One piece BSP female 60° cone

Hembras giratorias rectas una sola pieza rosca BSP cono 60°

Dichtkopf mit Ü-Mutter einteilig BSP 60° kon.

Femelle pré-sertie BSP cône 60°



DN	ROSCA THREAD	Referencia Part n°	€
3/16"	1/4" BSP	871000403	22,47
1/4"	1/4" BSP	871000404	19,29
3/8"	3/8" BSP	871000606	23,39
1/2"	1/2" BSP	871000808	27,58
3/4"	3/4" BSP	871001212	42,68
1"	1" BSP	871001616	69,62

One piece BSP female 60° cone (90° Elbow)

Hembras giratorias 90° una sola pieza rosca BSP cono 60°

Dichtkopf mit BSP einteilig Ü-Mutter 60° kon. 90°

90° Femelle pré-sertie BSP cône 60°



DN	ROSCA THREAD	Referencia Part n°	€
3/16"	1/4" BSP	NEW 871070403	31,57
1/4"	1/4" BSP	871070404	26,83
1/4"	3/8" BSP	871070604	34,41
3/8"	3/8" BSP	871070606	31,78
1/2"	1/2" BSP	871070808	37,90
3/4"	3/4" BSP	871071212	65,66
1"	1" BSP	871071616	104,78

One piece BSP female 60° cone (45° Elbow)

Hembras giratorias 45° una sola pieza rosca BSP cono 60°

Dichtkopf mit BSP Ü-Mutter 60° einteilig kon. 45°

45° Femelle pré-sertie BSP cône 60°



DN	ROSCA THREAD	Referencia Part n°	€
3/16"	1/4" BSP	NEW 871080403	31,57
1/4"	1/4" BSP	871080404	26,83
3/8"	3/8" BSP	871080606	31,78
1/2"	1/2" BSP	871080808	37,90
3/4"	3/4" BSP	871081212	65,66
1"	1" BSP	871081616	104,78

One piece BSP male 60° cone

Machos una sola pieza rosca cilíndrica BSP cono 60°

Außengewinde zyl. einteilig kon. BSP 60°

Mâle pré-serti BSP cône 60°



DN	ROSCA THREAD	Referencia Part n°	€
1/4"	1/4" BSP	871120404	21,68
3/8"	3/8" BSP	871120606	25,35
1/2"	1/2" BSP	871120808	31,60
3/4"	3/4" BSP	871121212	46,22
1"	1" BSP	871121616	85,39

One piece fittings for Smooth PTFE/ R14

Conexiones una sola pieza PTFE Liso / R14
Einteilige Armaturen PTFE-Glattschlauch/ R14
Embouts pré-sertis pour PTFE lisse/ R14

One piece JIC 37° double hexagonal female

Hembras gir rectas una sola pieza rosca JIC 37°
doble hex

Dichtkopf einteilig Ü-Mutter 37° JIC doppelt 6 kt

Femelle pré-sertie JIC 37° double hexagonal



DN	ROSCA THREAD	Referencia Part n°	€
3/16"	7/16" 20h UNF	862420703	28,16
1/4"	7/16" 20h UNF	862420704	20,71
5/16"	7/16" 20h UNF	NEW 862420705	31,71
1/4"	1/2" 20h UNF	862420804	26,25
5/16"	1/2" 20h UNF	862420805	32,41
5/16"	9/16" 18h UNF	862420905	32,12
3/8"	9/16" 18h UNF	862420906	24,03
3/8"	3/4" 16h UNF	862421206	28,63
1/2"	3/4" 16h UNF	862421208	28,12
5/8"	3/4" 16h UNF	862421210	45,47
1/2"	3/4" 16h UNF	862421408	38,03
5/8"	3/4" 16h UNF	862421410	49,41
1/2"	1"1/16 12h UN	862421708	50,69
5/8"	1"1/16 12h UN	862421710	56,38
3/4"	1"1/16 12h UN	862421712	47,86
1"	1"1/16 12h UN	862421716	76,49
3/4"	1"5/16 12h UN	862422112	73,10
1"	1"5/16 12h UN	862422116	74,37

One piece JIC 37° female (90° Elbow)

Hembras giratorias 90° una sola pieza rosca JIC 37°

Dichtkopf einteilig Ü-Mutter 37° JIC 90°

90° Femelle pré-sertie JIC 37°



DN	ROSCA THREAD	Referencia Part n°	€
3/16"	7/16" 20h UNF	861380703	34,43
1/4"	7/16" 20h UNF	861380704	25,12
5/16"	9/16" 18h UNF	861380905	32,26
3/8"	9/16" 18h UNF	861380906	30,71
1/2"	3/4" 16h UNF	861381208	36,72
1/2"	7/8" 14UNF	861381408	39,15
5/8"	7/8" 14UNF	861381410	55,27
3/4"	1"1/16 12h UN	861381712	64,30
1"	1"5/16 12h UN	861382116	100,98

One piece JIC 37° male

Machos una sola pieza rosca JIC 37°

Außengewinde einteilig JIC 37°

Mâle pré-serti JIC 37°



DN	ROSCA THREAD	Referencia Part n°	€
1/4"	7/16" 20h UNF	861400704	22,59
3/8"	9/16" 18h UNF	861400906	29,85
1/2"	3/4" 16h UNF	861401208	29,44
5/8"	1"1/16 12h UN	861401710	53,74
3/4"	1"1/16 12h UN	861401712	49,99
1"	1"5/16 12h UN	861402116	76,37

One piece JIC 37° female

Hembras giratorias rectas una sola pieza rosca JIC 37°

Dichtkopf einteilig Ü-Mutter 37° JIC

Femelle pré-sertie JIC 37°



DN	ROSCA THREAD	Referencia Part n°	€
1/4"	7/16" 20h UNF	861420704	17,84
3/16"	7/16" 20h UNF	861420703	21,34
1/4"	1/2" 20h UNF	861420804	19,02
5/16"	1/2" 20h UNF	861420805	23,65
5/16"	9/16" 18h UNF	861420905	20,91
3/8"	9/16" 18h UNF	861420906	20,20
3/8"	3/4" 16h UNF	861421206	24,53
1/2"	3/4" 16h UNF	861421208	25,26
3/4"	1"1/16 12h UN	861421712	39,82
1"	1"5/16 12h UN	861422116	62,66

One piece JIC 37° female (45° Elbow)

Hembras giratorias 45° una sola pieza rosca JIC 37°

Dichtkopf einteilig Ü-Mutter 37° JIC 45°

45° Femelle pré-sertie JIC 37°



DN	ROSCA THREAD	Referencia Part n°	€
1/4"	7/16" 20h UNF	861390704	25,12
5/16"	9/16" 18h UNF	861390905	32,26
3/8"	9/16" 18h UNF	861390906	30,71
1/2"	3/4" 16h UNF	861391208	36,72
1/2"	7/8" 14h UNF	861391408	39,15
5/8"	7/8" 14h UNF	861391410	55,27
3/4"	1"1/16 12h UN	861391712	64,30
1"	1"5/16 12h UN	861392116	100,98

One piece fittings for Smooth PTFE/ R14

Conexiones una sola pieza PTFE Liso / R14
Einteilige Armaturen PTFE-Glattschlauch/ R14
Embouts pré-sertis pour PTFE lisse/ R14

One piece doble hexagonal ORFS female

Hembras giratorias rectas una sola pieza rosca ORFS doble hex

Dichtkopf mit ORFS einteilig Ü-Mutter doppelt 6 kt

Femelle pré-sertie ORFS double hexagonal



One piece ORFS male

Machos una sola pieza rosca ORFS

Außengewinde einteilig ORFS

Mâle pré-serti ORFS



DN	ROSCA THREAD	Referencia Part n°	€
1/4"	9/16"-18h	869000904	33,95
5/16"	11/16"-16h	869001105	43,09
3/8"	11/16"-16h	869001106	38,18
1/2"	13/16"-16h	869001308	43,76
3/4"	1"3/16-12h	869001912	70,77
1"	1"7/16-12h	869002316	119,08

DN	ROSCA THREAD	Referencia Part n°	€
1/4"	9/16"-18h	869120904	39,73
3/8"	11/16"-16h	869121106	38,94
1/2"	13/16"-16h	869121308	48,33
3/4"	1"3/16-12h	869121912	87,48
1"	1"7/16-12h	869122316	122,99

One piece ORFS female (90° Elbow)

Hembras giratorias 90° una sola pieza rosca ORFS

Dichtkopf mit ORFS einteilig Ü-Mutter 90°

90° Femelle pré-sertie ORFS



One piece ORFS female (45° Elbow)

Hembras giratorias 45° una sola pieza rosca ORFS

Dichtkopf mit ORFS einteilig Ü-Mutter 45°

45° Femelle pré-sertie ORFS



DN	ROSCA THREAD	Referencia Part n°	€
1/4"	9/16"-18h	869070904	58,33
3/8"	11/16"-16h	869071106	69,68
1/2"	13/16"-16h	869071308	81,13
5/8"	1" 14 UNS	NEW 869071610	109,43
3/4"	1"3/16-12h	869071912	130,27
1"	1"7/16-12h	869072316	190,92

DN	ROSCA THREAD	Referencia Part n°	€
1/4"	9/16"-18h	869080904	58,33
3/8"	11/16"-16h	869081106	69,68
1/2"	13/16"-16h	869081308	81,13
3/4"	1"3/16-12h	869081912	130,27
1"	1"7/16-12h	869082316	190,92

One piece fittings for Smooth PTFE/ R14

Conexiones una sola pieza PTFE Liso / R14
Einteilige Armaturen PTFE-Glattschlauch/ R14
Embouts pré-sertis pour PTFE lisse/ R14

One piece double hexagonal NPSM female 60° cone

Hembras giratorias rectas una sola pieza NPSM (60°) doble hex

Dichtkopf mit NPSM einteilig Ü-Mutter 60° kon. doppelt 6 kt

Femelle pré-sertie NPSM cône 60° double hexagonal



DN	ROSCA THREAD	Referencia Part n°	€
1/4"	1/4" NPSM	863610404	31,03
3/8"	3/8" 18h NPSM	863610606	32,75
1/2"	1/2" 14h NPSM	863610808	38,90
3/4"	3/4" NPSM	863611212	59,24
1"	1" - 11 1/2 h NPSM	863611616	93,13

One piece NPSM female 60° cone

Hembras giratorias rectas una sola pieza rosca NPSM cono 60°

Dichtkopf mit NPSM einteilig Ü-Mutter 60° kon.

Femelle pré-sertie NPSM cône 60°



DN	ROSCA THREAD	Referencia Part n°	€
1/4"	1/4" 18h NPSM	862610404	20,79
3/8"	3/8" 18h NPSM	862610606	22,48
1/2"	1/2" 14h NPSM	862610808	30,35
3/4"	3/4" 14h NPSM	862611212	45,88
1"	1" - 11 1/2 h NPSM	862611616	72,37

One piece NPSM female 60° cone (90° Elbow)

Hembras giratorias 90° una sola pieza rosca NPSM cono 60°

Dichtkopf mit NPSM einteilig Ü-Mutter 60° kon. 90°

90° Femelle pré-sertie NPSM cône 60°



DN	ROSCA THREAD	Referencia Part n°	€
1/4"	1/4" 18h NPSM	862620404	30,11
3/8"	3/8" 18h NPSM	862620606	34,91
1/2"	1/2" 14h NPSM	862620808	47,51
3/4"	3/4" 14h NPSM	862621212	70,99
1"	1" - 11 1/2 h NPSM	862621616	106,28

One piece NPSM female 60° cone (45° Elbow)

Hembras giratorias 45° una sola pieza rosca NPSM cono 60°

Dichtkopf mit NPSM einteilig Ü-Mutter 60° kon. 45°

45° Femelle pré-sertie NPSM cône 60°



DN	ROSCA THREAD	Referencia Part n°	€
1/4"	1/4" 18h NPSM	862630404	30,11
3/8"	3/8" 18h NPSM	862630606	34,91
1/2"	1/2" 14h NPSM	862630808	47,51
3/4"	3/4" 14h NPSM	862631212	70,99
1"	1" - 11 1/2 h NPSM	862631616	106,28

One piece NPT male pipe

Machos una sola pieza rosca cónica NPT

Außengewinde einteilig kon. NPT

Mâle pré-serti NPT



DN	ROSCA THREAD	Referencia Part n°	€
1/4"	1/8" NPT	861610204	23,52
3/16"	1/4" NPT	861610403	27,43
1/4"	1/4" NPT	861610404	17,78
5/16"	1/4" NPT	861610405	26,68
3/8"	1/4" NPT	861610406	26,63
1/4"	3/8" NPT	861610604	25,48
5/16"	3/8" NPT	861610605	29,09
3/8"	3/8" NPT	861610606	20,22
1/2"	1/2" NPT	861610608	32,56
3/8"	1/2" NPT	861610806	32,68
1/2"	1/2" NPT	861610808	26,01
5/8"	1/2" NPT	861610810	40,76
1/2"	3/4" NPT	861611208	44,31
5/8"	3/4" NPT	861611210	52,52
3/4"	3/4" NPT	861611212	42,02
3/4"	1" NPT	861611612	67,68
1"	1" NPT	861611616	68,05
1"	1" 1/4 NPT	861612016	110,73

One piece fittings for Smooth PTFE/ R14

Conexiones una sola pieza PTFE Liso / R14
Einteilige Armaturen PTFE-Glattschlauch/ R14
Embouts pré-sertis pour PTFE lisse/ R14

One piece Metric female 24° cone

Hembras gir DKO rectas una sola pieza rosca Métrica 24°

Dichtkopf metr. einteilig Ü-Mutter kon. 24°

Femelle pré-sertie Métrique cône 24°



DN	TUBO PIPE	SERIE SERIES	ROSCA THREAD	Referencia Part n°	€
1/4"	8	L	M14x1.5	86804140804	17,14
3/8"	12	L	M18x1.5	86804181206	20,69
1/2"	12	L	M18x1.5	86804181208	35,63
1/2"	15	L	M22x1.5	86804221508	26,83
3/4"	18	L	M26x1.5	86804261812	58,11
3/4"	22	L	M30x2	86804302212	45,22
1"	28	L	M36x2	86804362816	71,46
1/4"	8	S	M16x1.5	86804160804	18,85
3/8"	12	S	M20x1.5	86804201206	23,46
1/2"	16	S	M24x1.5	86804241608	26,99
3/4"	25	S	M36x2	86804362512	64,80
1"	30	S	M42x2	86804423016	90,27

One piece Metric female 24° cone (90° Elbow)

Hembras gir DKO90° una sola pieza rosca Métrica 24°

Dichtkopf 90° metr. einteilig Ü-Mutter kon. 24°

90° Femelle pré-sertie Métrique cône 24°



DN	TUBO PIPE	SERIE SERIES	ROSCA THREAD	Referencia Part n°	€
1/4"	8	L	M14x1.5	86305140804	25,58
3/8"	12	L	M18x1.5	86305181206	30,29
1/2"	15	L	M22x1.5	86305221508	37,73
3/4"	22	L	M30x2	86305302212	70,13
1"	28	L	M36x2	86305362816	106,08
1/4"	8	S	M16x1.5	86305160804	29,70
3/8"	12	S	M20x1.5	86305201206	34,94
1/2"	16	S	M24x1.5	86305241608	40,25
3/4"	25	S	M36x2	86305362512	96,09
1"	30	S	M42x2	86305423016	143,41

One piece Metric male 24° cone

Machos compactos rosca Métrica cono 24°

Außengewinde einteilig metr. kon. 24°

Mâle pré-serti Métrique cône 24°



DN	TUBO PIPE	SERIE SERIES	ROSCA THREAD	Referencia Part n°	€
1/4"	8	L	M14x1.5	86203140804	20,75
3/8"	12	L	M18x1.5	86203181206	19,15
1/2"	15	L	M22x1.5	86203221508	26,88
3/4"	22	L	M30x2	86203302212	50,67
1"	28	L	M36x2	86203362816	76,77
1/4"	8	S	M16x1.5	86203160804	26,43
3/8"	12	S	M20x1.5	86203201206	27,65
1/2"	16	S	M24x1.5	86203241608	29,88
3/4"	25	S	M36x2	86203362512	72,63
1"	30	S	M42x2	86203423016	114,12

One piece Metric female 24° cone (45° Elbow)

Hembras gir DKO45° una sola pieza rosca Métrica 24°

Dichtkopf 45° metr. einteilig Ü-Mutter kon. 24°

45° Femelle pré-sertie Métrique cône 24°



DN	TUBO PIPE	ROSCA THREAD	SERIE SERIES	Referencia Part n°	€
1/4"	8	M14x1.5	L	86306140804	25,58
3/8"	12	M18x1.5	L	86306181206	30,29
1/2"	15	M22x1.5	L	86306221508	37,73
3/4"	22	M30x2	L	86306302212	70,13
1"	28	M36x2	L	86306362816	106,08
1/4"	8	M16x1.5	S	86306160804	29,70
3/8"	12	M20x1.5	S	86306201206	34,94
1/2"	16	M24x1.5	S	86306241608	40,25
3/4"	25	M36x2	S	86306362512	96,09
1"	30	M42x2	S	86306423016	143,41

One piece fittings for Smooth PTFE/ R14

Conexiones una sola pieza PTFE Liso / R14
Einteilige Armaturen PTFE-Glattschlauch/ R14
Embouts pré-sertis pour PTFE lisse/ R14

One piece double hexagonal BSP female 60° cone

Hembras giratorias rectas una sola pieza BSP (60°) doble hex

Dichtkopf mit Überwurfmutter einteilig BSP 60° kon. doppelt 6 kt

Femelle pré-sertie BSP cône 60° double hexagonal



DN	ROSCA THREAD	Referencia Part n°	€
1/4"	1/4" BSP	864000404	26,08
3/8"	3/8" BSP	864000606	29,16
1/2"	1/2" BSP	864000808	31,29
3/4"	3/4" BSP	864001212	58,03
1"	1" BSP	864001616	81,50

One piece BSP female 60° cone (90° Elbow)

Hembras giratorias 90° una sola pieza rosca BSP cono 60°

Dichtkopf mit Ü-Mutter einteilig BSP 60° kon. 90°

90° Femelle pré-sertie BSP cône 60°



DN	ROSCA THREAD	Referencia Part n°	€
1/4"	1/4" BSP	861070404	24,12
3/8"	3/8" BSP	861070606	28,06
1/2"	1/2" BSP	861070808	34,33
1/2"	3/4" BSP	NEW 861071208	54,38
3/4"	3/4" BSP	861071212	62,45
1"	1" BSP	861071616	97,86

One piece BSP male 60° cone

Machos una sola pieza rosca cilíndrica BSP cono 60°

Außengewinde zyl. einteilig kon. BSP 60°

Mâle pré-serti BSP cône 60°



DN	ROSCA THREAD	Referencia Part n°	€
1/4"	1/4" BSP	861120404	18,97
3/8"	3/8" BSP	861120606	21,63
1/2"	1/2" BSP	861120808	28,03
3/4"	3/4" BSP	861121212	43,01
1"	1" BSP	861121616	78,47

One piece BSP female 60° cone

Hembras giratorias rectas una sola pieza rosca BSP cono 60°

Dichtkopf mit Ü-Mutter einteilig BSP 60° kon.

Femelle pré-sertie BSP cône 60°



DN	ROSCA THREAD	Referencia Part n°	€
3/16"	1/4" BSP	861000403	23,51
1/4"	1/4" BSP	861000404	16,58
3/8"	3/8" BSP	861000606	19,67
1/2"	1/2" BSP	861000808	24,01
3/4"	3/4" BSP	861001212	39,47
1"	1" BSP	861001616	62,70

One piece BSP female 60° cone (45° Elbow)

Hembras giratorias 45° una sola pieza rosca BSP cono 60°

Dichtkopf mit Überwurfmutter einteilig BSP 60° kon. 45°

45° Femelle pré-sertie BSP cône 60°



DN	ROSCA THREAD	Referencia Part n°	€
1/4"	1/4" BSP	861080404	24,12
3/8"	3/8" BSP	861080606	28,06
1/2"	1/2" BSP	861080808	34,33
3/4"	3/4" BSP	861081212	62,45
1"	1" BSP	861081616	97,86

One piece gas standpipe

Espiga lisa una sola pieza recta gas

Stutzen gerade GAS einteilig glatt

Embout pré-serti lisse droit gas



TUBO PIPE	DN	Referencia Part n°	€
6.4	1/4"	861590604	16,84
9.5	3/8"	861590906	20,29
12.7	3/8"	861591206	21,92
12.7	1/2"	861591208	22,73
15.8	5/8"	861591510	37,83
19.05	3/4"	NEW 861591912	42,84
25.4	1"	NEW 861592516	62,68

One piece fittings for convoluted PTFE

Conexiones una sola pieza PTFE Corrugado
Einteilige Armaturen PTFE-Wellenschlauch
Embouts pré-sertis pour PTFE convoluté

One piece JIC 37° double hexagonal female

Hembras giratorias rectas una sola pieza rosca JIC 37° doble hex

Dichtkopf einteilig Ü-Mutter 37° JIC doppelt 6 kt

Femelle pré-sertie JIC 37° double hexagonal



DN	ROSCA THREAD	Referencia Part n°	€
1/4"	7/16" 20h UNF	852420704	21,49
3/8"	1/2" 20 UNF	852420806	31,66
3/8"	9/16" 18h UNF	852420906	24,24
1/2"	3/4" 16h UNF	852421208	29,05
1/2"	7/8" 14UNF	852421408	38,96
5/8"	7/8" 14UNF	852421410	45,73
5/8"	1"1/16 12 UN	852421710	52,70
3/4"	1"1/16 12h UN	852421712	49,35
1"	1"5/16 12h UN	852422116	78,10
1"1/4	1"5/8 12h UN	852422620	140,32
1"1/2	1"7/8 12h UN	852423024	185,20
2"	2"1/2 12h UN	852424032	364,43

One piece JIC 37° female (90° Elbow)

Hembras giratorias 90° una sola pieza rosca JIC 37°

Dichtkopf einteilig Ü-Mutter 37° JIC 90°

90° Femelle pré-sertie JIC 37°



DN	ROSCA THREAD	Referencia Part n°	€
1/4"	7/16" 20h UNF	851380704	25,91
3/8"	9/16" 18h UNF	851380906	30,92
1/2"	3/4" 16h UNF	851381208	37,65
3/4"	1"1/16 12h UN	851381712	65,79
1"	1"5/16 12h UN	851382116	104,72
1"1/4	1"5/8 12h UN	851382620	168,77
1"1/2	1"7/8 12h UN	851383024	258,59
2"	2"1/2 12h UN	851384032	527,63

One piece JIC 37° male

Machos una sola pieza rosca JIC 37°

Außengewinde einteilig JIC 37°

Mâle pré-serti JIC 37°



DN	ROSCA THREAD	Referencia Part n°	€
1/4"	7/16" 20h UNF	851400704	23,38
3/8"	9/16" 18h UNF	851400906	30,06
1/2"	3/4" 16h UNF	851401208	30,37
5/8"	1"1/16 12h UN	851401710	50,07
3/4"	1"1/16 12h UN	851401712	51,49
1"	1"5/16 12h UN	851402116	80,11
1"1/4	1"5/8 12h UN	851402620	136,86
1"1/2	1"7/8 12h UN	851403024	165,38
2"	2"1/2 12h UN	851404032	341,68

One piece JIC 37° female

Hembras giratorias rectas una sola pieza rosca JIC 37°

Dichtkopf einteilig Ü-Mutter 37° JIC

Femelle pré-sertie JIC 37°



DN	ROSCA THREAD	Referencia Part n°	€
1/4"	7/16" 20h UNF	851420704	18,63
5/16"	1/2" 20h UNF	851420805	23,85
3/8"	9/16" 18h UNF	851420906	20,41
1/2"	3/4" 16h UNF	851421208	26,19
3/4"	1"1/16 12h UN	851421712	41,31
1"	1"5/16 12h UN	851422116	66,39
1" 1/4	1"5/8 12h UN	851422620	110,89
1"1/2	1"7/8 12h UN	851423024	151,96
2"	2" 1/2 12h UN	851424032	277,06

One piece JIC 37° female (45° Elbow)

Hembras giratorias 45° una sola pieza rosca JIC 37°

Dichtkopf einteilig Ü-Mutter 37° JIC 45°

45° Femelle pré-sertie JIC 37°



DN	ROSCA THREAD	Referencia Part n°	€
1/4"	7/16" 20h UNF	851390704	25,91
3/8"	9/16" 18h UNF	851390906	30,93
1/2"	3/4" 16h UNF	851391208	37,65
3/4"	1"1/16 12h UN	851391712	65,79
1"	1"5/16 12h UN	851392116	104,72
1"1/4	1"5/8 12h UN	851392620	168,77
1"1/2	1"7/8 12h UN	851393024	258,59
2"	2"1/2 12h UN	851394032	527,63

One piece fittings for convoluted PTFE

Conexiones una sola pieza PTFE Corrugado
Einteilige Armaturen PTFE-Wellenschlauch
Embouts pré-sertis pour PTFE convoluté

One piece doble hexagonal ORFS female

Hembras giratorias rectas una sola pieza rosca ORFS doble hex

Dichtkopf mit ORFS einteilig Ü-Mutter doppelt 6 kt

Femelle pré-sertie ORFS double hexagonal



DN	ROSCA THREAD	Referencia Part n°	€
1/4"	9/16"-18h	859000904	34,74
3/8"	11/16"-16h	859001106	38,39
1/2"	13/16"-16h	859001308	44,69
3/4"	1"3/16-12h	859001912	72,26
1"	1"7/16-12h	859002316	122,82
1"1/4	1"11/16-16h	859002720	189,87
1"1/2	2" 12h	859003224	228,37

One piece ORFS female (90° Elbow)

Hembras giratorias 90° una sola pieza rosca ORFS

Dichtkopf mit ORFS einteilig Ü-Mutter 90°

90° Femelle pré-sertie ORFS



DN	ROSCA THREAD	Referencia Part n°	€
1/4"	9/16"-18h	859070904	59,12
3/8"	11/16"-16h	859071106	69,89
1/2"	13/16"-16h	859071308	82,06
3/4"	1"3/16-12h	859071912	131,76
1"	1"7/16-12h	859072316	194,66
1"1/4	1"11/16-16h	859072720	278,42
1"1/2	2" 12h	859073224	734,76

One piece ORFS male

Machos una sola pieza rosca ORFS

Außengewinde einteilig ORFS

Mâle pré-serti ORFS



DN	ROSCA THREAD	Referencia Part n°	€
1/4"	9/16"-18h	859120904	40,52
3/8"	11/16"-16h	859121106	39,16
1/2"	13/16"-16h	859121308	49,26
3/4"	1"3/16-12h	859121912	88,97
1"	1"7/16-12h	859122316	126,72
1"1/4	1"11/16 12h	859122720	180,78
1"1/2	2" 12h	859123224	262,24

One piece ORFS female (45° Elbow)

Hembras giratorias 45° una sola pieza rosca ORFS

Dichtkopf mit ORFS einteilig Ü-Mutter 45°

45° Femelle pré-sertie ORFS



DN	ROSCA THREAD	Referencia Part n°	€
1/4"	9/16"-18h	859080904	59,12
3/8"	11/16"-16h	859081106	69,89
1/2"	13/16"-16h	859081308	82,06
3/4"	1"3/16-12h	859081912	131,76
1"	1"7/16-12h	859082316	194,65
1"1/4	1"11/16-16h	859082720	278,42
1"1/2	2" 12h	859083224	734,76

One piece fittings for convoluted PTFE

Conexiones una sola pieza PTFE Corrugado
Einteilige Armaturen PTFE-Wellenschlauch
Embouts pré-sertis pour PTFE convoluté

One piece double hexagonal NPSM female 60° cone

Hembras gir rectas una sola pieza NPSM (60°) doble hex
Dichtkopf mit NPSM einteilig Ü-Mutter 60° kon. doppelt 6 kt
Femelle pré-sertie NPSM cône 60° double hexagonal



DN	ROSCA THREAD	Referencia Part n°	€
1/4"	1/4" NPSM	853610404	31,82
3/8"	3/8" 18h NPSM	853610606	32,96
1/2"	1/2" 14h NPSM	853610808	39,83
3/4"	3/4" NPSM	853611212	60,73
1"	1" - 11 1/2 h NPSM	853611616	96,87

One piece NPSM female 60° cone

Hembras giratorias rectas una sola pieza rosca NPSM cono 60°
Dichtkopf mit NPSM einteilig Ü-Mutter 60° kon.
Femelle pré-sertie NPSM cône 60°



DN	ROSCA THREAD	Referencia Part n°	€
1/4"	1/4" 18h NPSM	852610404	21,57
3/8"	3/8" 18h NPSM	852610606	22,69
1/2"	1/2" 14h NPSM	852610808	31,28
3/4"	3/4" 14h NPSM	852611212	47,37
1"	1" - 11 1/2 h NPSM	852611616	76,10

One piece NPSM female 60° cone (90° Elbow)

Hembras giratorias 90° una sola pieza rosca NPSM cono 60°
Dichtkopf mit NPSM einteilig Ü-Mutter 60° kon. 90°
90° Femelle pré-sertie NPSM cône 60°



DN	ROSCA THREAD	Referencia Part n°	€
1/4"	1/4" 18h NPSM	852620404	30,90
3/8"	3/8" 18h NPSM	852620606	35,12
1/2"	1/2" 14h NPSM	852620808	48,44
3/4"	3/4" 14h NPSM	852621212	72,48
1"	1" - 11 1/2 h NPSM	852621616	110,01

One piece NPSM female 60° cone (45° Elbow)

Hembras giratorias 45° una sola pieza rosca NPSM cono 60°
Dichtkopf mit NPSM einteilig Ü-Mutter 60° kon. 45°
45° Femelle pré-sertie NPSM cône 60°



DN	ROSCA THREAD	Referencia Part n°	€
1/4"	1/4" 18h NPSM	852630404	30,90
3/8"	3/8" 18h NPSM	852630606	35,12
1/2"	1/2" 14h NPSM	852630808	48,44
3/4"	3/4" 14h NPSM	852631212	72,48
1"	1" - 11 1/2 h NPSM	852631616	110,01

One piece NPT male pipe straight

Machos una sola pieza rosca cónica NPT
Außengewinde einteilig kon. NPT
Mâle pré-serti NPT



DN	ROSCA THREAD	Referencia Part n°	€
1/4"	1/8" NPT	851610204	24,30
1/4"	1/4" NPT	851610404	18,57
5/16"	1/4" NPT	851610405	26,88
3/8"	1/4" NPT	851610406	26,85
1/4"	3/8" NPT	851610604	26,27
5/16"	3/8" NPT	851610605	29,29
3/8"	3/8" NPT	851610606	20,43
1/2"	3/8" NPT	851610608	33,49
3/8"	1/2" NPT	851610806	32,90
1/2"	1/2" NPT	851610808	26,94
5/8"	1/2" NPT	851610810	37,09
1/2"	3/4" NPT	851611208	45,24
5/8"	3/4" NPT	851611210	48,84
3/4"	3/4" NPT	851611212	43,51
3/4"	1" NPT	851611612	69,17
1"	1" NPT	851611616	71,78
1"	1" 1/4 NPT	851612016	114,46
1" 1/4"	1" 1/4 NPT	851612020	125,27
1" 1/2"	1" 1/2 NPT	851612424	153,14
2"	2" NPT	851613232	261,24

One piece fittings for convoluted PTFE

Conexiones una sola pieza PTFE Corrugado

Einteilige Armaturen PTFE-Wellenschlauch

Embouts pré-sertis pour PTFE convoluté

One piece Metric female 24° cone

Hembras gir DKO rectas una sola pieza rosca Métrica cono 24°

Dichtkopf metr. einteilig Ü-Mutter kon. 24°

Femelle pré-sertie Métrique cône 24°



DN	TUBO PIPE	SERIE SERIES	ROSCA THREAD	Referencia Part n°	€
1/4"	8	L	M14x1.5	85804140804	17,93
3/8"	12	L	M18x1.5	85804181206	20,91
1/2"	15	L	M22x1.5	85804221508	27,76
3/4"	22	L	M30x2	85804302212	46,71
1"	28	L	M36x2	85804362816	75,20
1"1/4	35	L	M45x2	85804453520	110,94
1"1/2	42	L	M52x2	85804524224	159,47
1/4"	8	S	M16x1.5	85804160804	19,64
3/8"	12	S	M20x1.5	85804201206	23,68
1/2"	16	S	M24x1.5	85804241608	27,92
3/4"	25	S	M36x2	85804362512	66,29
1"	30	S	M42x2	85804423016	94,00
1"1/4	38	S	M52x2	85804523820	155,30

One piece Metric female 24° cone (90° Elbow)

Hembras gir DKO 90° una sola pieza rosca Métrica cono 24°

Dichtkopf 90° metr. einteilig Ü-Mutter kon. 24°

90° Femelle pré-sertie Métrique cône 24°



DN	TUBO PIPE	ROSCA THREAD	SERIE SERIES	Referencia Part n°	€
1/4"	8	M14x1.5	L	85305140804	26,37
3/8"	12	M18x1.5	L	85305181206	30,50
1/2"	15	M22x1.5	L	85305221508	38,66
3/4"	22	M30x2	L	85305302212	71,62
1"	28	M36x2	L	85305362816	109,81
1"1/4	35	M45x2	L	85305453520	180,05
1"1/2	42	M52x2	L	85305524224	273,46
1/4"	8	M16x1.5	S	85305160804	30,49
3/8"	12	M20x1.5	S	85305201206	35,15
1/2"	16	M24x1.5	S	85305241608	41,18
3/4"	25	M36x2	S	85305362512	97,58
1"	30	M42x2	S	85305423016	147,15
1"1/4	38	M52x2	S	85305523820	247,79

One piece Metric male 24° cone

Machos una sola pieza rosca Métrica cono 24°

Außengewinde einteilig metr. kon. 24°

Mâle pré-serti Métrique cône 24°



DN	TUBO PIPE	SERIE SERIES	ROSCA THREAD	Referencia Part n°	€
1/4"	8	L	M14x1.5	85203140804	21,53
3/8"	12	L	M18x1.5	85203181206	19,36
1/2"	15	L	M22x1.5	85203221508	27,81
3/4"	22	L	M30x2	85203302212	52,16
1"	28	L	M36x2	85203362816	80,51
1"1/4	35	L	M45x2	85203453520	133,84
1"1/2	42	L	M52x2	85203524224	193,79
1/4"	8	S	M16x1.5	85203160804	27,21
3/8"	12	S	M20x1.5	85203201206	27,87
1/2"	16	S	M24x1.5	85203241608	30,81
3/4"	25	S	M36x2	85203362512	74,12
1"	30	S	M42x2	85203423016	117,85
1"1/4	38	S	M52x2	85203523820	182,50

One piece Metric female 24° cone (45° Elbow)

Hembras gir DKO 45° una sola pieza rosca Métrica cono 24°

Dichtkopf 45° metr. einteilig Ü-Mutter kon. 24°

45° Femelle pré-sertie Métrique cône 24°



DN	TUBO PIPE	SERIE SERIES	ROSCA THREAD	Referencia Part n°	€
1/4"	8	L	M14x1.5	85306140804	26,37
3/8"	12	L	M18x1.5	85306181206	30,50
1/2"	15	L	M22x1.5	85306221508	38,66
3/4"	22	L	M30x2	85306302212	71,62
1"	28	L	M36x2	85306362816	109,81
1"1/4	35	L	M45x2	85306453520	180,05
1"1/2	42	L	M52x2	85306524224	273,46
1/4"	8	S	M16x1.5	85306160804	30,49
3/8"	12	S	M20x1.5	85306201206	35,15
1/2"	16	S	M24x1.5	85306241608	41,18
3/4"	25	S	M36x2	85306362512	97,58
1"	30	S	M42x2	85306423016	147,15
1"1/4	38	S	M52x2	85306523820	247,79

One piece fittings for convoluted PTFE

Conexiones una sola pieza PTFE Corrugado
Einteilige Armaturen PTFE-Wellenschlauch
Embouts pré-sertis pour PTFE convoluté

One piece double hexagonal BSP female 60° cone

Hembras giratorias rectas una sola pieza rosca BSP (60°) doble hex
Dichtkopf mit Ü-Mutter einteilig BSP 60° kon. doppelt 6 kt

Femelle pré-sertie BSP cône 60° double hexagonal



DN	ROSCA THREAD	Referencia Part n°	€
1/4"	1/4" BSP	854000404	26,87
3/8"	3/8" BSP	854000606	29,37
1/2"	1/2" BSP	854000808	32,22
3/4"	3/4" BSP	854001212	59,52
1"	1" BSP	854001616	85,24
1"1/4	1"1/4 BSP	854002020	129,90
1"1/2	1"1/2 BSP	854002424	193,30
2"	2" BSP	854003232	333,77

One piece BSP female 60° cone (90° Elbow)

Hembras giratorias 90° una sola pieza rosca BSP cono 60°

Dichtkopf mit Ü-Mutter einteilig BSP 60° kon. 90°

90° Femelle pré-sertie BSP cône 60°



DN	ROSCA THREAD	Referencia Part n°	€
1/4"	1/4" BSP	851070404	24,91
3/8"	3/8" BSP	851070606	28,28
1/2"	1/2" BSP	851070808	35,26
3/4"	3/4" BSP	851071212	63,94
1"	1" BSP	851071616	101,59
1"1/4	1"1/4 BSP	851072020	170,56
1"1/2	1"1/2 BSP	851072424	252,19
2"	2" BSP	851073232	452,34

One piece BSP male 60° cone

Machos una sola pieza rosca cilíndrica BSP cono 60°

Außengewinde zyl. einteilig kon. BSP 60°

Mâle pré-serti BSP cône 60°



DN	ROSCA THREAD	Referencia Part n°	€
1/4"	1/4" BSP	851120404	19,76
3/8"	3/8" BSP	851120606	21,84
1/2"	1/2" BSP	851120808	28,96
3/4"	3/4" BSP	851121212	44,50
1"	1" BSP	851121616	82,20
1"1/4	1"1/4 BSP	851122020	138,50
1"1/2	1"1/2 BSP	851122424	169,00
2"	2" BSP	851123232	279,96

One piece BSP female 60° cone

Hembras giratorias rectas una sola pieza rosca BSP cono 60°

Dichtkopf mit Ü-Mutter einteilig BSP 60° kon.

Femelle pré-sertie BSP cône 60°



DN	ROSCA THREAD	Referencia Part n°	€
1/4"	1/4" BSP	851000404	17,37
3/8"	3/8" BSP	851000606	19,89
1/2"	1/2" BSP	851000808	24,94
3/4"	3/4" BSP	851001212	40,96
1"	1" BSP	851001616	66,43
1"1/4	1"1/4 BSP	851002020	111,82
1"1/2	1"1/2 BSP	851002424	139,52
2"	2" BSP	851003232	242,23

One piece BSP female 60° cone (45° Elbow)

Hembras giratorias 45° una sola pieza rosca BSP cono 60°

Dichtkopf mit Ü-Mutter einteilig BSP 60° kon. 45°

45° Femelle pré-sertie BSP cône 60°



DN	ROSCA THREAD	Referencia Part n°	€
1/4"	1/4" BSP	851080404	24,91
3/8"	3/8" BSP	851080606	28,28
1/2"	1/2" BSP	851080808	35,26
3/4"	3/4" BSP	851081212	63,94
1"	1" BSP	851081616	101,59
1"1/4	1"1/4 BSP	851082020	170,56
1"1/2	1"1/2 BSP	851082424	252,19
2"	2" BSP	851083232	452,34

Reusable series

Conexiones Reusables
Schraubarmaturen
Embouts série récupérable

One Piece Swivel Female R2AT JIC 37°

Hembras giratorias rectas una sola pieza R2T rosca JIC 37°

Dichtkopf mit Ü-Mutter Einteilig R2T Gewinde JIC 37°

Femelle tournante 1 pièce R2AT JIC 37°



DN	ROSCA THREAD	Referencia Part n°	€
1/4"	7/16" 20h UNF	Z3J-07-04-R2T	63,83
3/8"	9/16" 18h UNF	Z3J-09-06-R2T	64,01
1/2"	3/4" 16h UNF	Z3J-12-08-R2T	72,92
1/2"	7/8" 14h UNF	Z3J-14-08-R2T	89,87
5/8"	7/8" 14h UNF	Z3J-14-10-R2T	100,02
3/4"	1" 1/16 12h UNF	Z3J-17-12-R2T	122,81
1"	1" 5/16 12h UNF	Z3J-21-16-R2T	185,01

One Piece Male R2AT NPT

Machos una sola pieza R2T rosca cónica NPT

Aussengewinde Einteilig R2T Kegelig NPT

Mâle 1 pièce 2AT NPT



DN	ROSCA THREAD	Referencia Part n°	€
1/4"	1/4" NPT	Z2NPT-04-04-R2T	59,36
3/8"	3/8" NPT	Z2NPT-06-06-R2T	61,39
1/2"	1/2" NPT	Z2NPT-08-08-R2T	69,47
3/4"	3/4" NPT	Z2NPT-12-12-R2T	114,71
1"	1" NPT	Z2NPT-16-16-R2T	151,24

Reusable ferrules R1T/1SN non skive

Casquillos reus para manguera R1T/1SN no pelar

Schraubfassung für R1T/1SN ohne Schälén

Jupes récupérables R1T/1SN sans dénudage



DN	Referencia Part n°	€
1/4"	Z1G-4 R1T INOX	30,00
5/16"	Z1G-5 R1T INOX	41,53
3/8"	Z1G-6 R1T INOX	26,94
1/2"	Z1G-8 R1T INOX	33,35
3/4"	Z1G-12 R1T INOX	45,79
1"	Z1G-16 R1T INOX	82,15

Reusable ferrules R2AT/2SN non skive

Casquillos reus para manguera R2AT/2SN no pelar

Schraubfassung für R2AT/2SN ohne Schälén

Jupes récupérables R2AT/2SN sans dénudage



DN	Referencia Part n°	€
1/4"	Z1G-4 R2T INOX	30,83
3/8"	Z1G-6 R2T INOX	25,57
1/2"	Z1G-8 R2T INOX	28,52
5/8"	Z1G-10 R2T INOX	46,48
3/4"	Z1G-12 R2T INOX	54,76
1"	Z1G-16 R2T INOX	71,95

Reusable BSP Swivel female 60° cone

Hembras giratorias rectas reusables rosca BSP cono 60°

Dichtkopf mit BSP Ü-Mutter

Femelle récupérable gaz cylindrique 60°



DN	ROSCA THREAD	Referencia Part n°	€
1/4"	1/4" BSP	Z3G-4	31,28
5/16"	3/8" BSP	Z3G-6-5	34,79
3/8"	3/8" BSP	Z3G-6	33,59
3/8"	1/2" BSP	Z3G-8-6	40,59
1/2"	1/2" BSP	Z3G-8	38,99
3/4"	3/4" BSP	Z3G-12	59,31
1"	1" BSP	Z3G-16	101,42
1" 1/4"	1" 1/4 BSP	Z3G-20	197,60
1" 1/2"	1" 1/2 BSP	Z3G-24*	239,08

*Until end of stock / Hasta fin de existencias / Bis zum Ende des Lagerbestandes / Jusqu'à la fin du stock

Reusable BSP 60° cone (90° Elbow)

Hembras giratorias 90° reusables rosca BSP cono 60°

Dichtkopf mit BSP Ü-Mutter 90° Bogen

Coude 90° femelle récupérable gaz cylindrique BSP 60°



DN	ROSCA THREAD	Referencia Part n°	€
1/4"	1/4" BSP	Z90G-4	55,67
3/8"	3/8" BSP	Z90G-6	66,71
3/8"	1/2" BSP	Z90G-8-6	87,41
1/2"	1/2" BSP	Z90G-8	82,49
3/4"	3/4" BSP	Z90G-12	110,94
1"	1" BSP	Z90G-16	174,65

Reusable BSP Male parallel 60° cone

Machos reusables rosca cilíndrica BSP cono 60°

BSP Einschraubzapfen zyl. DIN 3852 Form A

Mâle récupérable gaz cylindrique BSP 60°



DN	ROSCA THREAD	Referencia Part n°	€
1/4"	1/4" BSP	Z2G-4	37,54
3/8"	3/8" BSP	Z2G-6-5	44,67
3/8"	3/8" BSP	Z2G-6	33,85
3/8"	1/2" BSP	Z2G-8-6	40,24
1/2"	1/2" BSP	Z2G-8	37,33
3/4"	3/4" BSP	Z2G-12	61,52
1"	1" BSP	Z2G-16	80,31

Reusable series

Conexiones Reusables
Schraubarmaturen
Embouts série récupérable

Reusable JIC 37° straight Swivel female

Hembras giratorias rectas reusables rosca JIC cono 37°

Schraubarmaturen Ü-Mutter Dichtkonus JIC 37°

Femelle droite récupérable JIC 37°



DN	ROSCA THREAD	Referencia Part n°	€
1/4"	7/16" 20h UNF	Z3J-07-04	34,41
3/8"	9/16" 18h UNF	Z3J-09-06	36,94
1/2"	3/4" 16h UNF	Z3J-12-08	42,89
1/2"	7/8" 14h UNF	Z3J-14-08	59,85
5/8"	7/8" 14h UNF	Z3J-14-10	52,04
3/4"	1"1/16 12h UNF	Z3J-17-12	66,55
1"	1"5/16 12h UNF	Z3J-21-16	111,56

Reusable JIC Male 37° cone

Machos reusables rosca JIC cono 37°

Schraubarmaturen Außengewindenippel
Dichtkonus JIC 37°

Mâle récupérables JIC cône 37°



DN	ROSCA THREAD	Referencia Part n°	€
1/4"	7/16" 20h UNF	Z2J-07-04	39,97
3/8"	9/16" 18h UNF	Z2J-09-06	42,26
1/2"	3/4" 16h UNF	Z2J-12-08	44,49
1/2"	7/8" 14h UNF	Z2J-14-08	65,35
5/8"	7/8" 14h UNF	Z2J-14-10	64,79
3/4"	1"1/16 12h UNF	Z2J-17-12	78,61
1"	1"5/16 12h UNF	Z2J-21-16	130,77

90° reusable Swivel female thread JIC cone 37°

Hembras giratorias 90° reusables rosca JIC cono 37°

90° drehbarer, wiederverwendbarer JIC-Konus mit
-Gewinde 37°

Femelle tournante 90° filetage récupérable cône
JIC 37°



DN	ROSCA THREAD	Referencia Part n°	€
1/4"	7/16" 20h UNF	Z3J90-07-04	71,45
3/8"	9/16" 18h UNF	Z3J90-09-06	85,92
1/2"	3/4" 16h UNF	Z3J90-12-08	112,81
1/2"	7/8" 14h UNF	Z3J90-14-08	100,73
5/8"	7/8" 14h UNF	Z3J90-14-10	141,44
3/4"	1"1/16 12h UN	Z3J90-17-12	198,79
1"	1"5/16 12h UN	Z3J90-21-16	253,34

45° reusable Swivel female thread JIC cone 37°

Hembras giratorias 45° reusables rosca JIC cono 37°

45° drehbarer, wiederverwendbarer JIC-Konus mit
-Gewinde 37°

Femelle tournante 45° filetage récupérable cône
JIC 37°



DN	ROSCA THREAD	Referencia Part n°	€
1/4"	7/16" 20h UNF	Z3J45-07-04	71,45
3/8"	9/16" 18h UNF	Z3J45-09-06	85,92
1/8"	3/4" 16h UNF	Z3J45-12-08	112,81
1/2"	7/8" 14h UNF	Z3J45-14-08	100,73
5/8"	7/8" 14h UNF	Z3J45-14-10	141,44
3/4"	1"1/16 12h UN	Z3J45-17-12	198,79
1"	1"5/16 12h UN	Z3J45-21-16	253,34

Reusable NPT Male

Machos reusables rosca NPT

Wiederverwendbare Außengewinde NPT

Mâle récupérable NPT



DN	ROSCA THREAD	Referencia Part n°	€
1/4"	1/4" NPT	Z2NPT-04-04	29,72
3/8"	3/8" NPT	Z2NPT-06-06	31,97
1/2"	1/2" NPT	Z2NPT-08-08	39,41
3/4"	3/4" NPT	Z2NPT-12-12	58,45
1"	1" NPT	Z2NPT-16-16	77,79

Reusable Metric standpipe

Espigas lisas Métricas reusables

Metr. Einschraubstutzen glatt

Embout lisse récupérable Métrique



DN	TUBO PIPE	Referencia Part n°	€
1/4"	6	ZE-6-4	29,18
1/4"	8	ZE-8-4	27,76
3/8"	8	ZE-8-6	26,96
1/4"	10	ZE-10-4	30,85
5/16"	10	ZE-10-5	31,28
3/8"	10	ZE-10-6	40,35
5/16"	12	ZE-12-5	31,28
3/8"	12	ZE-12-6	44,84
3/8"	15	ZE-15-6	40,35
1/2"	15	ZE-15-8	44,01
1/2"	16	ZE-16-8	43,98
3/4"	22	ZE-22-12	66,68
3/4"	25	ZE-25-12	92,40
1"	25	ZE-25-16	*
1"	28	ZE-28-16	*
1"	30	ZE-30-16	*

Reusable series

Conexiones Reusables
Schraubarmaturen
Embouts série récupérable

Reusable R5 JIC 37° straight swivel female

Hembras giratorias rectas reusables R5 rosca JIC cono 37°

Wiederverwendbare gerade drehbare Innengewinde R5 JIC mit 37° -Konus

Femelle pivotante droite réutilisable R5 JIC filetage 37° cône



DN	ROSCA THREAD	Referencia Part n°	€
3/16"	7/16" 20 UNF	Z3J-07-04-R5	36,26
1/4"	7/16" 20h UNF	Z3J-07-05-R5	36,56
1/4"	1/2" 20h UNF	Z3J-08-05-R5	37,21
5/16"	1/2" 20h UNF	Z3J-08-06-R5	38,33
5/16"	9/16" 18h UNF	Z3J-09-06-R5	38,86
13/32"	3/4" 16h UNF	Z3J-12-08-R5	42,22
1/2"	3/4" 16h UNF	Z3J-12-10-R5	65,48
1/2"	7/8"x14 UNF	Z3J-14-10-R5	72,95
5/8"	1" 1/16" 12 UNF	Z3J-17-12-R5	82,90
7/8"	1" 5/16" 12 UNF	Z3J-21-16-R5	111,49
1" 1/8"	1" 5/8 12 UNF	Z3J-26-20-R5	250,08
1" 3/8"	1" 7/8 12 UNF	Z3J-30-24-R5	290,23
1" 13/16"	2" 1/2 12UNF	Z3J-40-32-R5	502,79

Reusable R5 JIC 37° swivel female (90° elbow)

Hembras giratorias 90° reusables R5 rosca JIC cono 37°

90° drehbarer, wiederverwendbarer JIC-Konus mit R5-Gewinde 37°

Femelle pivotante 90° filetage R5 réutilisable cône JIC 37°



DN	ROSCA THREAD	Referencia Part n°	€
3/16"	7/16" 20 UNF	Z3J90-07-04-R5	64,32
1/4"	7/16" 20h UNF	Z3J90-07-05-R5	76,49
1/4"	1/2" 20h UNF	Z3J90-08-05-R5	78,02
5/16"	9/16" 18h UNF	Z3J90-09-06-R5	83,18
13/32"	3/4" 16h UNF	Z3J90-12-08-R5	103,80
1/2"	3/4" 16h UNF	Z3J90-12-10-R5	131,62
1/2"	7/8" 14 UNF	Z3J90-14-10-R5	136,79
5/8"	1" 1/16 12 UNF	Z3J90-17-12-R5	209,46
7/8"	1" 5/16" 12 UNF	Z3J90-21-16-R5	245,13

Reusable R5 NPT Male

Machos reusables R5 rosca NPT

Wiederverwendbare Außengewinde R5 NPT

Mâle récupérables R5 NPT



DN	ROSCA THREAD	Referencia Part n°	€
3/16"	1/4" NPT	Z2P-04-04-R5	33,43
1/4"	1/4" NPT	Z2P-04-05-R5	35,61
5/16"	3/8" NPT	Z2P-06-06-R5	39,25
13/32"	1/2" NPT	Z2P-08-08-R5	41,38
1/2"	1/2" NPT	Z2P-08-10-R5	54,23
5/8"	3/4" NPT	Z2P-12-12-R5	72,32
7/8"	1" NPT	Z2P-16-16-R5	90,21
1" 1/8"	1" 1/4 NPT	Z2P-20-20-R5	146,91
1" 3/8"	1" 1/2 NPT	Z2P-24-24-R5	191,81
1" 13/16"	2" NPT	Z2P-32-32-R5	388,84

Reusable R5 JIC 37° swivel female (45° elbow)

Hembras giratorias 45° reusables R5 rosca JIC cono 37°

45° wiederverwendbar. Innengewinde R5, JIC-Konus 37°

Femelle pivotante 45° réutilisable Filetage R5 cône JIC 37°



DN	ROSCA THREAD	Referencia Part n°	€
3/16"	7/16" 20 UNF	Z3J45-07-04-R5	69,20
1/4"	7/16" 20h UNF	Z3J45-07-05-R5	81,08
1/4"	1/2" 20h UNF	Z3J45-08-05-R5	76,71
5/16"	9/16" 18h UNF	Z3J45-09-06-R5	77,51
13/32"	3/4" 16h UNF	Z3J45-12-08-R5	109,18
1/2"	3/4" 16h UNF	Z3J45-12-10-R5	125,41
1/2"	7/8" 14 UNF	Z3J45-14-10-R5	130,96
5/8"	1" 1/16 12 UNF	Z3J45-17-12-R5	192,20
7/8"	1" 5/16" 12 UNF	Z3J45-21-16-R5	226,78

CONEXIONES REUSABLES R5

REUSABLE R5 FITTINGS



Consulta datos en nuestra ficha técnica | Check our technical sheet for data

Sistemas hidráulicos de **media presión** con fluidos basados en petróleo o agua/glycol, aceites y lubricantes.

Medium pressure hydraulic systems with petroleum or water/glycol based fluids and for fuel and lubricating oils

Push-On Fittings

Conexiones Push-On
Aufsteck-Armaturen
Embouts Push-On

BSP Swivel female 60° cone

Hembras giratorias rectas rosca BSP cono 60°

Dichtkopf mit BSP Ü-Mutter

Femelle tournante BSP cône 60°



NPT Male pipe straight

Machos rosca cónica NPT

Außengewinde NPT

Mâle gaz conique NPT (BRIGGS)

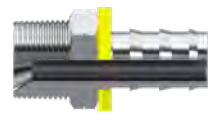

DN	ROSCA THREAD	Referencia Part n°	€
1/4"	1/4" BSP	891000404	17,26
3/8"	3/8" BSP	891000606	18,80
1/2"	1/2" BSP	891000808	19,86
5/8"	5/8" BSP	891001010	38,28
3/4"	3/4" BSP	891001212	31,12
1"	1" BSP	891001616	48,76

DN	ROSCA THREAD	Referencia Part n°	€
1/4"	1/4" NPT	891610404	14,15
3/8"	3/8" NPT	891610606	20,16
1/2"	1/2" NPT	891610808	24,71
3/4"	3/4" NPT	891611212	36,91
1"	1" NPT	891611616	48,01

BSP Male 60° cone

Machos rosca cilíndrica BSP cono 60°

Außengewinde BSP

Mâle fixe BSP cône 60°



Metric female swivel with o-ring 24° cone

Hembra giratoria recta Métrica cono 24°

Dichtkopf metr. Ü-Mutter kon. 24°

Femelle Métrique avec o-ring cône 24°

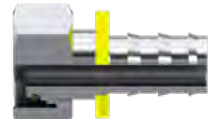

DN	ROSCA THREAD	Referencia Part n°	€
1/4"	1/4" BSP	891120404	18,20
3/8"	3/8" BSP	891120606	20,17
1/2"	1/2" BSP	891120808	25,13
3/4"	1/2" BSP	891120812	35,93
5/8"	5/8" BSP	891121010	33,74
3/4"	3/4" BSP	891121212	41,99
1"	1" BSP	891121616	52,79

DN	TUBO PIPE	SERIE SERIES	ROSCA THREAD	Referencia Part n°	€
1/4"	6	L	M12x1.5	89804120604	16,54
1/4"	8	L	M14x1.5	89804140804	19,30
1/4"	10	L	M16x1.5	89804161004	18,48
3/8"	12	L	M18x1.5	89804181206	19,58
1/2"	15	L	M22x1.5	89804221508	22,21
3/4"	22	L	M30x2	89804302212	38,00

JIC 37° Swivel female

Hembras giratorias rectas JIC 37°

Dichtkonus mit Ü-Mutter JIC 37°

Femelle tournante JIC 37°



Metric stud 24° cone

Machos rosca métrica cono 24°

Gewindezapfen L/S DIN 20078 D/E

Mâle Métrique cône 24°



DN	ROSCA THREAD	Referencia Part n°	€
1/4"	7/16" 20h UNF	891420704	15,68
3/8"	9/16" 18h UNF	891420906	18,71
1/2"	3/4" 16h UNF	891421208	23,30
5/8"	7/8" 14h UNF	891421410	27,18
3/4"	1" 1/16 12h UN	891421712	34,74
1"	1" 5/16 12h UN	891422116	45,30

DN	TUBO PIPE	SERIE SERIES	ROSCA THREAD	Referencia Part n°	€
1/4"	8	L	M14x1.5	89203140804	17,24
1/4"	10	L	M16x1.5	89203161004	18,86
3/8"	12	L	M18x1.5	89203181206	19,81
1/2"	15	L	M22x1.5	89203221508	24,73
3/4"	22	L	M30x2	89203302212	35,41

JIC 37° Male

Machos rosca JIC cono 37°

Außengewinde JIC 37°

Mâle fixe JIC 37°



DN	ROSCA THREAD	Referencia Part n°	€
1/4"	7/16" 20h UNF	891400704	16,49
3/8"	9/16" 18h UNF	891400906	22,82
1/2"	3/4" 16h UNF	891401208	23,42
5/8"	7/8" 14h UNF	891401410	32,30
3/4"	1" 1/16 12h UN	891401712	41,64
1"	1" 5/16 12h UN	891402116	52,08

High pressure 700 bar fittings

Conexiones Alta Presión (700 bar)

Armaturen Hochdruck (700bar)

Embouts haute pression 700 bar

Ferrules for thermoplastic hose 700 bar

Casquillos para alta presión (700bar)

Pressfassungen Hochdruck (700bar)

Jupes à sertir thermoplastique 700 bar



DN	Referencia Part n°	€
1/4"	Z710120400	31,72
3/8"	Z710120600	32,98
1/2"	Z710120800	34,96

BSP Swivel female 60° cone 700 bar

Hembra giratoria BSP cono 60° (700bar)

Dichtkopf mit Ü-Mutter BSP 60° (700bar)

Embout 700 bar femelle tournante gaz cyl BSP 60°



DN	ROSCA THREAD	Referencia Part n°	€
1/4"	1/4" BSP	Z741000404	54,75
3/8"	3/8" BSP	Z741000606	57,60
1/2"	1/2" BSP	Z741000808	59,92

BSP Male parallel 60° cone 700 bar

Macho BSP cono 60° (700bar)

Außengewinde BSP kon. 60° (700bar)

Embout 700 bar mâle fixe gaz cyl BSP 60°



DN	ROSCA THREAD	Referencia Part n°	€
1/4"	1/4" BSP	Z741120404	63,14
3/8"	3/8" BSP	Z741120606	65,20
1/2"	1/2" BSP	Z741120808	70,64

NPSM Swivel female 60° cone 700 bar

Hembra giratoria NPSM cono 60° (700bar)

Dichtkonus mit NPSM 60°

Embout 700 bar femelle tournante NPSM 60°



DN	ROSCA THREAD	Referencia Part n°	€
1/4"	1/4" 18h NPSM	Z742610404	54,75
3/8"	3/8" 18h NPSM	Z742610606	60,63
1/2"	1/2" 14h NPSM	Z742610808	63,07

NPT Male pipe straight 700 bar

Macho NPT (700bar)

Außengewinde NPT (700bar)

Embout 700 bar mâle fixe gaz conique NPT



DN	ROSCA THREAD	Referencia Part n°	€
1/4"	1/4" NPT	Z741610404	63,14
1/4"	3/8" NPT	Z741610604	68,46
3/8"	3/8" NPT	Z741610606	65,20
1/2"	1/2" NPT	Z741610808	70,64

JIC 37° Swivel female 700 bar

Hembra giratoria JIC 37° (700bar)

Dichtkopf mit Ü-Mutter JIC 37° (700bar)

Embout 700 bar femelle tournante droit JIC 37°



DN	ROSCA THREAD	Referencia Part n°	€
1/4"	7/16" 20h UNF	Z741420704	60,22
1/4"	9/16" 18h UNF	Z741420904	67,29
3/8"	9/16" 18h UNF	Z741420906	63,36
1/2"	3/4" 16h UNF	Z741421208	65,91

JIC 37° Male thread 700 bar

Macho JIC 37° (700bar)

Außengewinde JIC 37° (700bar)

Embout 700 bar mâle fixe JIC 37°



DN	ROSCA THREAD	Referencia Part n°	€
1/4"	7/16" 20h UNF	Z741400704	73,11
3/8"	9/16" 18h UNF	Z741400906	75,50
1/2"	3/4" 16h UNF	Z741401208	81,80

Metric Swivel female 24° cone 700 bar

Hembra giratoria Métrica 24° (700bar)

Dichtkopf Ü-Mutter metr. 24° (700bar)

Embout 700 bar femelle tournante droit Métrique cône 24°



DN	TUBO PIPE	SERIE SERIES	ROSCA THREAD	Referencia Part n°	€
1/4"	8	S	M16x1.5	Z74804160804	78,79
3/8"	12	S	M20x1.5	Z74804201206	80,52
1/2"	16	S	M24x1.5	Z74804241608	81,30

Metric Male 24° cone 700 bar

Macho Métrico 24° (700bar)

Außengewinde metr. 24° (700bar)

Embout 700 bar mâle fixe Métrique cône 24°



DN	TUBO PIPE	SERIE SERIES	ROSCA THREAD	Referencia Part n°	€
1/4"	8	S	M16x1.5	Z74203160804	84,41
3/8"	12	S	M20x1.5	Z74203201206	94,36
1/2"	16	S	M24x1.5	Z74203241608	105,25

Certificado de Material Material Certificate

NEW

PACK CERTIFICADO STOCK SPAIN STOCK GERMANY

30	75	75 UN	<input checked="" type="checkbox"/>
30	250	250 UN	<input checked="" type="checkbox"/>

Se puede calcular el peso y la cantidad

MARK CHECK

Certificados de Calidad Quality Certificates

DOWNLOAD

Certificados

La calidad de nuestros productos y empresa es uno de nuestros valores. Consulta nuestros certificados

Tablas De Prensado Crimping Charts

DOWNLOAD

ACERO INOXIDABLE - STAINLESS-STEEL TrAde GOLD TrAde GREENLINE DICSA

MANIFUEIRA HIDRAULICA - CONEXIONES STD - HYDRAULIC HOSES - STANDARD SERIES FITTINGS

Modelo	Material	Longitud	Diámetro	Presión	Aplicación
EN 837 20C	20C	15,8	16,8	19	21,6
EN 837 20C	20C	19,8	19,3	17,6	21,3
EN 837 20C	20C	23,8	21,6	21,3	26,7
EN 837 20C	20C	27,8	21,6	21,3	32,7

CERTIFICATE OF COMPLIANCE EN 10264 2.1

Customer: XXXX

Formularios De Hidráulica Hydraulic Forms

DOWNLOAD

DICSA

FECHA	
CLIENTE	
TELÉFONO	
CORREO	
CONTACTO	

FORMULARIO SOLICITUD OFERTA ACUMULADORES

MARCA: _____ REFERENCIA: _____

CANTIDAD: _____

Si no disponemos de la marca solicitada ¿le interesa alternativa? SI NO

VEIGA Boudin

MEMBRANA

VOLUMEN (LITROS): _____

ROSCA ENTRADA ACEITE: _____

CARGA NITRÓGENO (bar): AN

APLICACIÓN: _____

PRESIÓN MÁXIMA (bar): _____

OBSERVACIONES: _____

Formularios de Hidráulica

- ACUMULADORES
- ROBINS
- FILTROS
- VALVULAS ELECTRICAS
- VALVULAS HIDRAULICAS
- COMPRESORES Y ACCESORIOS
- CLAVOS
- ELABORACIONES
- PLACAS BASE PARA ELECTROVALVULAS
- ROBINS MANUALES
- DISTRIBUIDORES
- HYDRONEUMATICOS
- PLACAS BASE PARA ELECTROVALVULAS

Catálogos Interactivos Price Lists And Leaflets

DOWNLOAD

Lista de precios y folletos de productos

Consulta o encarga nuestros catálogos y gamas de productos fil-lineare

Lista de precios

Folletos de Productos

**TODA LA
INFORMACIÓN EN UN
¡CLICK!**

ASISTENTE DE LATIGUILLOS HOSE CONFIGURATOR



Makes your work easier

Evitar errores de configuración, nunca fue tan fácil.

Prevent configuration mistakes, it's never been easier

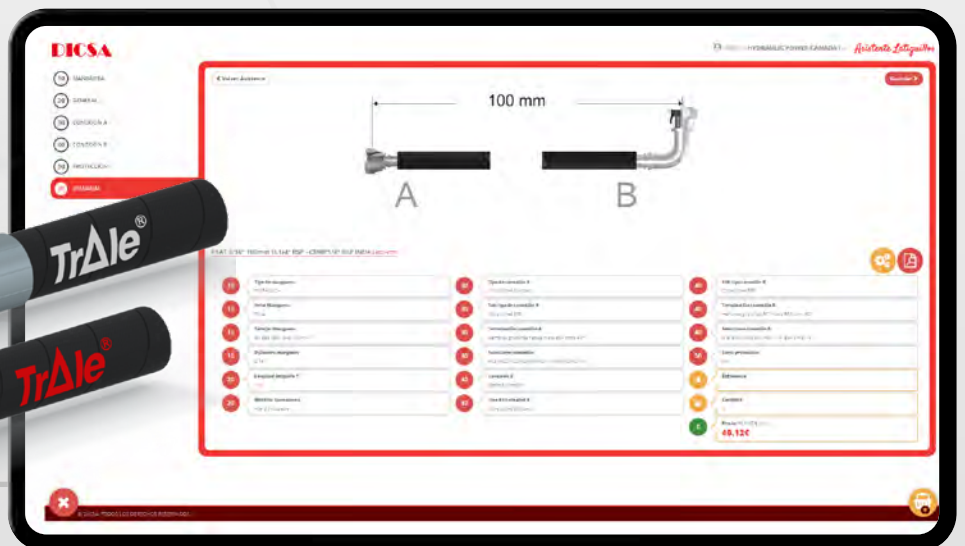
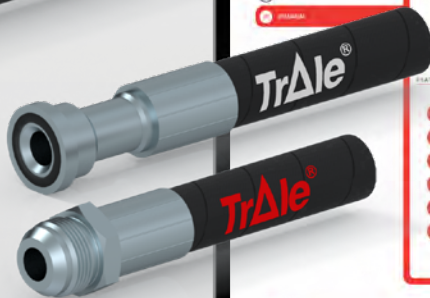

Elige la manguera

Choose the hose

Selecciona las conexiones

Select the fittings

Elige las protecciones

Choose the protections

PEDIDO FINAL
ORDER

Pongase en contacto
con nosotros para
más información.

Contact us for
further information.

CRIMPING MACHINES

Prensas
Pressen
Presses

TrAde®

MANGUERA HIDRÁULICA · HYDRAULIC HOSES

MANUALES · MANUAL

PM 18 6J N

80 T +20 mm
59 mm 28 kg.



TrAde®
1" 2SP
3/4" 4SP
1/2" 6SP

PM16-8J

100 T +20 mm
59 mm 25 kg.



TrAde®
1" 3SP

PM16 ELBOW-8J

100 T +20 mm
59 mm 25 kg.



TrAde®
1" 3SP



PM16-SPEED-8J

100 T +20 mm
59 mm 25 kg.



TrAde®
1" 3SP

PM18F-9J

120 T +20 mm
65 mm 22 kg.



TrAde®
1" 4SP

PM22-9J

140 T +25 mm
110 mm 22 kg.



TrAde®
1" 1/4 4SP

PM22P-9J

140 T +20 mm
110 mm 55 kg.



TrAde®
1" 1/4 4SP

ELÉCTRICAS · ELECTRICAL

PE 28 9J NT

170 T
+26 mm
110 mm



TrAde®
1" 1/4 4SP

PE 38 15J NT

220 T
+32 mm
130 mm



TrAde®
2" 4SP
1" 6SP

PE 50 17J NT

420 T
+32 mm
130 mm



TrAde®
2" 6SP

Bajo pedido
Under Request



SE 28 5J N/10J N

137 T
+28 mm
100 mm



TrAde®
1" 1/4 4SP

PE 38 12 J N

240 T
+38 mm
118 mm



TrAde®
2" 4SP
1" 6SP

PE 58 14J N | PE 58 14J 5.5 N

350 T
+54 mm
180 mm



TrAde®
2" 6SP
3" 2SP

MANGUERA HIDRÁULICA · HYDRAULIC HOSES

ELÉCTRICAS · ELECTRICAL

CHMT-20 N

Ø Max. 50mm

2,2 Kw

Ø 250 mm



TrAle®
1"1/4 4SP

CHM4-32 N

Ø Max. 75mm

3 Kw

Ø 250 mm



TrAle®
2" 4SP

CHM4-32 N2

Ø Max. 75mm

4 Kw

Ø 300 mm



TrAle®
2" 4SH

CHM6-32 N

Ø Max. 125mm

5,5 Kw

Ø 520 mm

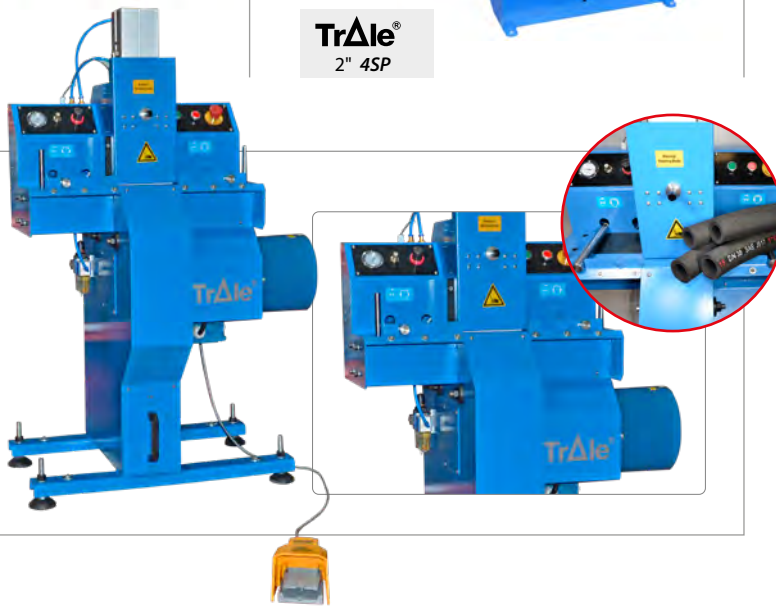

TrAle®
2" 6SP
2" IND



PORTARROLLOS, EXPOSITORES Y ENROLLADORES · REEL HOSE, ROLL HOLDERS AND EXHIBITORS

ROLLER



PRO7

Carga máx.
recomendada /
bandeja: 70 Kg.

Carga total
recomendada:
490 Kg.

Each holder max
70 kg

Total max.
capacity: 490 kg



PCM3

Carga máx. rollo: 35 Kg.

Each roll max 35 Kg.



ACCESORIOS PARA PRENSAS · ACCESSORIES FOR CRIMPING MACHINES

M PE 38 NT



SPEBD N



EGN | EGNT



PEDAL.N/NT



GARRAS ESPECIALES SPECIAL DIES



SKIVING MACHINES

Peladoras
Schälmaschinen
Dénudeuse



MANGUERA HIDRÁULICA · HYDRAULIC HOSES

PELADORA · SKIVING MACHINE

PB-32N



TrAle®
2"

Útiles / Tools



Portaherramientas.
Tool holder

PMT 2



Peladora Manual
Manual hose skiving

BANCO DE PRUEBAS · TEST BENCH

TB 2500



DESCUBRE NUESTRO
CATÁLOGO DE MÁQUINAS

DISCOVER OUR MACHINE
CATALOGUE



PIPE · TUBO RÍGIDO

DEBURRING MACHINE · DESBARBADORA

DEBUR01

R.P.M. 75

0.18 Kw

Ø 6-42 mm

30 kg



Útiles de desbarbado incluidos

Deburring tools included

ASSEMBLY MACHINE · MONTAJE

USFL/01 MAN

6 → 42 x 4 mm



DIN 2353

JIC 37°

TUBE2437

6 → 42 x 4 mm

0,75 Kw



DIN 2353

JIC 37°

BENDING MACHINES · DOBLADORAS

M18 6-18

6 → 18 mm



CMS42

6 → 42 x 4 mm



Con soporte
With tool-holder cabinet.

BENDER642

6 → 42 x 4 mm

1.1 Kw

Dobladora eléctrica con mueble.
Electric bending machine with cabinet



Bending & Assembly Machine Tools · Útiles para las máquinas de doblado y montaje de racores

CUC42



Matrices de doblado
Bending tools

TOOLHOLDER37



FT37
Matrices JIC 37°
Tools JIC 37°

BL

JIC 37°



Bloque BL JIC 37°
BL Block JIC 37°

TOOLHOLDER24

DIN 2353



Machos y matrices DIN 2353
Sockets & plates DIN 2353

WORK BENCH · BANCOS DE TRABAJO

CEN-MINI

1.7 Kw max.

210 kg.

Mini
Mini



Pequeño y económico
Small & inexpensive

CEN-JU

4.6 Kw max.

300 kg.

Max. Ø 100 mm.

220 l/min.
AIR

Completo
Complete



Con corte & aire comprimido
With cutting & compressed air



TrΔle® metric pipe 104

Tubo TrΔle® métrico
Metrisches Rohr TrΔle®
Tube rigide TrΔle® métrique

DIN 2353 Pipe fittings 105

Racores DIN 2353
Verschraubungen Din 2353
Raccords à bague DIN 2353

Flare fittings JIC 37° 125

Racores JIC 37°
JIC - Verbindungen
Adapteurs JIC 37°



02

PIPE FITTINGS

Tubo Rígido TrΔle®

Verschraubungen für Rohr

Raccord tube rigide



TrΔle®



RACORES FABRICADOS POR
PIPE FITTINGS MANUFACTURED BY

DICSA

CERTIFIED
ISO 9001
ISO 14001



SUSTAINABLE
DEVELOPMENT
GOALS

ACIE
AGENCIA DE CERTIFICACIÓN
EN INNOVACIÓN ESPAÑOLA

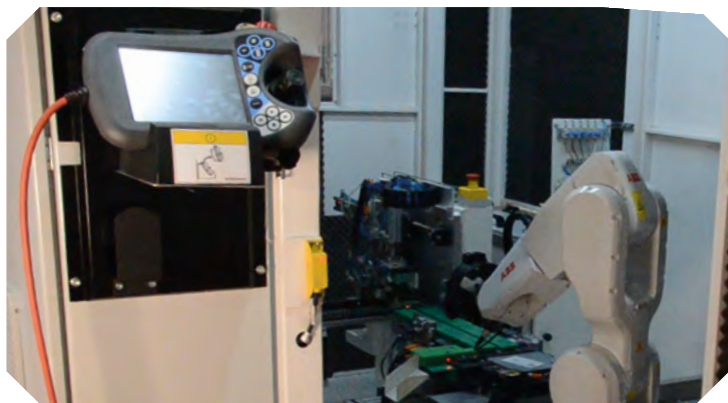

ASSEMBLY OF THE PIPE FITTINGS DIN 2353 IN THE RIGID PIPE (IT IS RECOMMENDED TO USE PRE-ASSEMBLY TOOLS)
INSTRUCCIONES DE MONTAJE DE RACOR DIN 2353 SOBRE EL TUBO RÍGIDO (SE RECOMIENDA EL USO DE HERRAMIENTAS DE PREMONTAJE)

1 PIPE SAW & PREPARATION
CORTE Y PREPARACIÓN DEL TUBO



- Clamp onto rigid fixtures
- Cut tube squarely and deburr thoroughly (max. ± 1° deviation)
- Do not use pipe cutters
- Fija el tubo a dispositivos rígidos
- Corta el tubo recto y sin rebabas (max. ± 1° de desviación)
- No utilice cortatubos

		MINIMUM HEIGHT(H): TWICE THREAD NUT LENGTH												MINIMUM HEIGHT(L): 2,5 - 3 TIMES THREAD NUT LENGTH											
Series Ø ext. Pipe	LL				L								S												
	H min.	4	5	6	8	6	8	10	12	15	18	22	28	35	42	6	8	10	12	14	16	20	25	30	38
L min.	24	25	25	26	31	31	33	33	36	38	42	42	48	48	35	35	37	37	43	43	50	54	58	65	
	30	32	32	33	39	39	42	42	45	48	53	53	60	60	44	44	47	47	54	54	63	68	73	82	

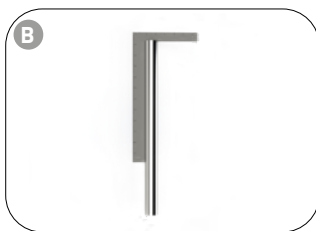

- Rectangulary saw off the pipe and remove all burrs.
- Cortar el tubo a escuadra y eliminar rebabas.



- Remove internal and external burrs
- Seal can be damaged by large burrs
- Quita las rebabas interiores y exteriores
- Las rebabas grandes pueden dañar las juntas

2 ASSEMBLY IN VICE
MONTAJE EN BANCO



- Use properly lubricants (GRASW120)
- Threads of stainless steel fittings must be lubricated
- Utiliza lubricantes específicos (GRASW120)
- Lubricar las roscas de los racores inox adecuadamente

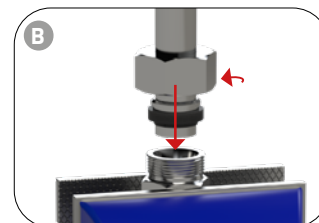

- Follow picture instructions
- Fitting body may be used one time only (use preassembly tools Z VOMO)
- Screw on nut until finger-tight
- Siga instrucciones de la imagen
- Utilizar el cuerpo del racor una única vez (use herramientas de montaje z vomo)
- Realiza el roscado de forma manual

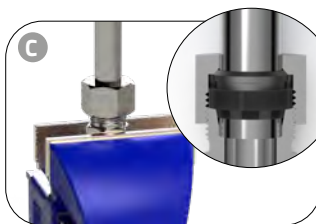

- Press tube-end firmly into the assembly cone
- Presione firmemente el final del tubo en el cono de montaje

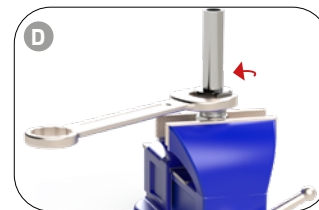

- Tighten until sharp increase of resistance (approx. 1 to 1 1/2 turns)
- Apriete hasta notar un fuerte incremento de resistencia (aprox. 1 ó 1,5 vueltas)

3 ASSEMBLY CHECK - CONTROL
COMPROBACIÓN DEL MONTAJE - CONTROL

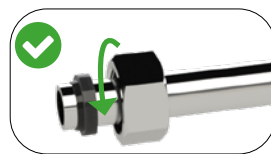
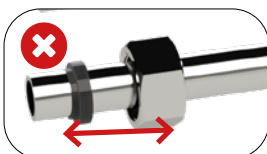

ZACJ2/ACJ2 CONTROL: GAP BETWEEN SEALING RING AND RETAINING RING MUST BE CHECKED

CONTROL ZACJ2/ACJ2: COMPROBAR EL ESPACIO ENTRE EL ANILLO DE ESTANQUEIDAD Y EL DE RETENCIÓN

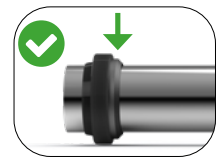
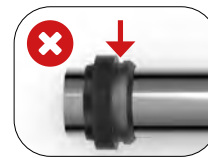

4 FINAL ASSEMBLY: INSTALLATION OF THE TUBE SYSTEM
MONTAJE FINAL: INSTALACIÓN DEL SISTEMA DE TUBO



- Repeat step 2. A
- Repetir paso 2.A



- Assemble fitting until wrench-tight. Then tighten fitting firmly by min. 1/6 (max. 1/4) turns (1 1/2 flats)
- Monta el racor hasta que quede apretado usando la llave. Apriete fuertemente el racor 1 ó 1,5 vueltas, en giros de 60° -90°.

TrΔle® metric pipe

Tubo TrΔle® métrico
Metrisches Rohr TrΔle®
Tube rigide TrΔle® métrique

Metric • Métrico • Metrisches • Métrique

| 104



ZTH0



ZTH0...-3

DIN 2353 Pipe fittings

Racores DIN 2353
Verschraubungen Din 2353
Raccords à bague DIN 2353

Nuts and cutting rings • Tuercas y anillos • Muttern und Schneidringe • Écrous et bagues

105



ZML/ZMS ZACL/ZACS ZVHS ZACJ ZACJ2 ZMIL/ZMJS

Straight couplings • Uniones tubo-tubo • Gerade Verschraubungen (G) • Raccords union double

107



ZDL/ZDS ZEL/ZES ZTL/ZTS ZKVL/ZKVS

Straight male stud couplings • Uniones rectas tubo-rosca • Gerade Einschraubverschr. - EVGE • Raccords union simple mâle

109



ZAL/ZAS RC ZAL/ZAS BSP WD ZAL/ZAS BSP ZAL/ZAS M WD ZAL/ZAS UNF ZAKL/ZAKS NPT ZAKL/ZAKS BSPT ZAKL/ZAKS METRIC

Male stud elbows • Codos tubo-rosca • W-Einschraubverschraubungen - WE • Raccords coude mâle gaz

112



ZCKL/ZCKS BSPT Z WEE ZCKL/ZCKS NPT ZCKL/ZCKS METRIC

Male stud barrel • TES rosca lateral • L-Einschraubverschraubungen - LE • Raccords Té mâle latéral

113



ZLKL/ZLKS BSPT ZLKL/ZLKS METRIC

Male stud branch • TES rosca central • T-Einschraubungen - TE • Raccords Té mâle central

113



ZFKL/ZFKS BSPT ZFKL/ZFKS METRIC

Metric unions • Uniones Métricas • Metr. Verschraubungen • Raccords union Métrique

114



ZKORL TLM ZKORS TLM

Reductions • Reducciones roscadas • Reduzierstutzen • Raccords de réduction

115



ZRI-R WD

Adjustable stud couplings • Racores regulables • Einstellbare Verschraubungen - EV • Raccords réglables

116



ZEEL/ZEES CTA ZEEL/ZEES TLM ZTEL/ZTES TLM ZLEL/ZLES TLM

DIN 2353 Pipe fittings

Racores DIN 2353
Verschraubungen Din 2353
Raccords à bague DIN 2353

Adjustable straight stud • Tubo roscado (hembra giratoria) • Einstellbarer gerader Einschraubstutzen - EV • Raccords tube fileté

117



ZATL/ZATS ZRAL/ZRAS BSP TLM WD ZRAL/ZRAS NPT TLM ZRAL/ZRAS METRIC TLM WD

Welding fittings • Soldables • Schweißarmaturen • Raccords à souder

118



ZASL/ZASS ZESVL/ZESVS ZORIL/ZORIS

Bulkhead • Pasatabiques • Schottverschraubungen - SV • Raccords passe cloison

119



ZSVL/ZSVS ZUSVL/ZUSVS KZTPM

Straight female coupling • Racor recto hembra • Gerade Aufschraub-Versch. - GAI • Raccords droits femelle

120



ZGAIL/ZGAIS BSP ZMAVL/ZMAVS ZAM ZGAIL/ZGAIS METRIC ZMAFL/ZMFAS

Banjos • Orientables • Ringaugen • Raccords orientables

121



ZWSVL/ZWSVS BSP ZWSVL/ZWSVS METRIC

Plugs • Tapones • Stopfen • Raccords bouchon métrique

122



ZBUTZEN L/S ZSTOPFEN BSP ZSTOPFEN METRIC

O-rings & captive seals • Juntas • Dichtringe - DOZ • Joints

122



JVT JVBSP/JVM

Accessories for the assembly • Accesorios para montaje • Zubehör für die Montage • Accessoires pour le montage

123



ZVOMO Grasa

Valves • Válvulas antirretorno • Rückschlagventil - RV • Valves clapet antiretour

124



ZRHVL/ZRHVS ZRHZL/ZRHZS ZRHDL/ZRHDS

Flare fittings JIC 37°

Racores JIC 37°
JIC - Verbindungen
Adapteurs JIC 37°

JIC 37° Nuts, sleeves and plugs • Tuercas, ferulas y tapones JIC 37° • Ü-Muttern, Druckringe und Verschlussstopfen JIC • Écrous, ferrules et bouchons JIC 37°

125



ZS110

ZS120

ZS121

ZS140

ZS130

JIC 37° Straight unions • Uniones rectas JIC 37° • gerade JIC-Verschraubungen • Union droite JIC 37°

126



ZS260

ZS260

ZS250

ZS260_OR

ZS240

ZS200

ZS380

ZS230

ZS180

ZS210

ZS295

ZS740

ZS291

ZS290

ZS185

JVMET

JVUNF

ZS730

JVMBSP

JTWJC

JIC 37° 90° Elbows • Codos 90° JIC 37° • 90° Winkel JIC 37° • Coudes 90° JIC 37°

131



ZS500

ZS675

ZS700

ZS500_OR

ZS650

ZS570

ZS575

ZS550

ZS595

ZS525

JIC 37° 45° Elbows • Codos 45 JIC 37° • 45° Winkel JIC 37° • Coudes 45° JIC 37°

133



ZS690

ZS775

ZS725

JIC 37° Tees • Tes JIC 37° • T-Verschraubungen JIC 37° • Tés JIC 37°

134



ZS505

ZS680

ZS630

ZS505_OR

ZS685

ZS625

TrΔle® metric pipe

Tubo TrΔle® métrico
Metrisches Rohr TrΔle®
Tube rigide TrΔle® métrique

Rigid pipe - 6 mts

Tubo rígido - 6 mts

Rohr - 6m

Tube rigide - 6 mts

**Rigid pipe - 3 mts**

Tubo rígido - 3 mts

Rohr - 3m

Tube rigide - 3 mts



Ø EXT. Ø OUTER	Ø INT. Ø INNER	Referencia Part n°	€/M
6	4	ZTH0060100	12,53
6	3	ZTH0060150	13,07
8	6	ZTH0080100	12,53
8	5	ZTH0080150	13,85
10	8	ZTH0100100	12,80
10	7	ZTH0100150	21,57
10	6	ZTH0100200	26,34
12	10	ZTH0120100	14,16
12	9	ZTH0120150	20,87
12	8	ZTH0120200	27,33
12	7	ZTH0120250	34,31
14	10	ZTH0140200	29,95
15	12	ZTH0150150	28,40
16	12	ZTH0160200	36,35
16	10	ZTH0160300	41,92
18	15	ZTH0180150	31,60
18	14	ZTH0180200	40,83
20	14	ZTH0200300	60,82
22	18	ZTH0220200	47,66
25	20	NEW ZTH0250250	64,36
25	19	ZTH0250300	77,32
28	24	ZTH0280200	70,41
30	24	ZTH0300300	98,43
35	31	ZTH0350200	75,01
38	30	ZTH0380400	135,74
42	38	ZTH0420200	87,05
42	36	ZTH0420300	158,33

Price per meter. / Precio por metro. / Die angegebenen Preise gelten pro Meter. / Les prix sont par mètre.

Ø EXT. Ø OUTER	Ø INT. Ø INNER	Referencia Part n°	€/M
6	4	ZTH0060100-3	13,15
6	3	ZTH0060150-3	13,73
8	6	ZTH0080100-3	13,16
8	5	ZTH0080150-3	14,54
10	8	ZTH0100100-3	13,44
10	7	ZTH0100150-3	22,65
12	10	ZTH0120100-3	14,87
10	6	ZTH0100200-3	27,66
12	9	ZTH0120150-3	21,91
12	8	ZTH0120200-3	28,70
12	7	ZTH0120250-3	36,03
14	10	ZTH0140200-3	31,45
15	12	ZTH0150150-3	29,82
16	12	ZTH0160200-3	38,17
16	10	ZTH0160300-3	44,02
18	15	ZTH0180150-3	33,18
18	14	ZTH0180200-3	42,87
20	14	ZTH0200300-3	63,86
22	18	ZTH0220200-3	50,04
25	20	NEW ZTH0250250-3	67,58
25	19	ZTH0250300-3	81,18
28	24	ZTH0280200-3	73,93
30	24	ZTH0300300-3	103,36
35	31	ZTH0350200-3	78,76
38	30	ZTH0380400-3	142,53
42	38	ZTH0420200-3	91,40
42	36	ZTH0420300-3	166,25

Price per meter. / Precio por metro. / Die angegebenen Preise gelten pro Meter. / Les prix sont par mètre.

TUBO SCHEDULE PIPE

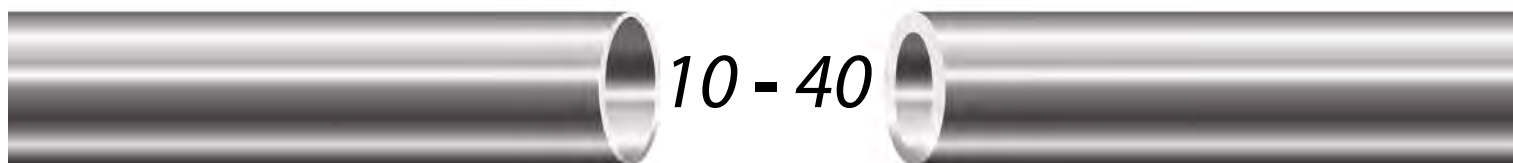

PÁGINA | PAGE

143

Consulta en nuestra ficha técnica datos | Check our technical sheet for data

DIN 2353 Pipe fittings

Racores DIN 2353

Verschraubungen Din 2353

Raccords à bague DIN 2353

Nuts DIN 3870

Tuercas Métricas DIN 3870

Muttern DIN 3870 (M)

Écrou DIN 3870



TUBO PIPE	SERIE SERIES	ROSCA THREAD	Referencia Part n°	€
4	LL	M8X1	Z MLL 4	3,91
6	LL	M10X1	Z MLL 6	3,59
8	LL	M12X1	Z MLL 8	4,18
6	L	M12X1.5	Z ML 6	2,19
8	L	M14X1.5	Z ML 8	2,64
10	L	M16X1.5	Z ML 10	3,04
12	L	M18X1.5	Z ML 12	3,65
15	L	M22X1.5	Z ML 15	5,28
18	L	M26X1.5	Z ML 18	8,21
22	L	M30X2	Z ML 22	10,66
28	L	M36X2	Z ML 28	21,93
35	L	M45X2	Z ML 35	36,67
42	L	M52X2	Z ML 42	45,78
6	S	M14X1.5	Z MS 6	2,87
8	S	M16X1.5	Z MS 8	3,23
10	S	M18X1.5	Z MS 10	4,05
12	S	M20X1.5	Z MS 12	4,49
14	S	M22X1.5	Z MS 14	7,31
16	S	M24X1.5	Z MS 16	8,12
20	S	M30X2	Z MS 20	12,38
25	S	M36X2	Z MS 25	29,22
30	S	M42X2	Z MS 30	37,58
38	S	M52X2	Z MS 38	57,15

Cutting rings DIN 3861

Anillos de corte DIN 3861

Schneidringe DIN 3861 (D)

Bague DIN 3861



TUBO PIPE	SERIE SERIES	Referencia Part n°	€
4	LL	Z ACLL 4	2,25
6	LL	Z ACLL 6	2,46
8	LL	Z ACLL 8	2,55
6	L/S	Z ACL 6	2,05
8	L/S	Z ACL 8	2,11
10	L/S	Z ACL 10	2,70
12	L/S	Z ACL 12	2,81
15	L	Z ACL 15	3,09
18	L	Z ACL 18	3,37
22	L	Z ACL 22	4,50
28	L	Z ACL 28	6,75
35	L	Z ACL 35	10,32
42	L	Z ACL 42	12,05
14	S	Z ACS 14	3,53
16	S	Z ACS 16	3,83
20	S	Z ACS 20	4,50
25	S	Z ACS 25	6,75
30	S	Z ACS 30	10,12
38	S	Z ACS 38	10,89

Reinforced ring

Anillos de refuerzo

Verstärkungsring

Bague de renforcement



TUBO PIPE	Referencia Part n°	€
4	Z VHS 4	*
5	Z VHS 5	*
6	Z VHS 6	*
7	Z VHS 7	*
8	Z VHS 8	*
9	Z VHS 9	*
10	Z VHS 10	*
11	Z VHS 11	*
12	Z VHS 12	*
13	Z VHS 13	*
14	Z VHS 14	*
15	Z VHS 15	*
16	Z VHS 16	*
17	Z VHS 17	*
18	Z VHS 18	*
19	Z VHS 19	*
20	Z VHS 20	*
22	Z VHS 22	*
24	Z VHS 24	*
25	Z VHS 25	*
31	Z VHS 31	*
33	Z VHS 33	*
38	Z VHS 38	*

Cutting ring with joint

Anillos de corte con junta

Schneidring mit Dichtung

Bague avec joint



TUBO PIPE	SERIE SERIES	Referencia Part n°	€
6	L	Z ACJL 6	5,04
8	L	Z ACJL 8	5,16
10	L	Z ACJL 10	5,81
12	L	Z ACJL 12	4,94
15	L	Z ACJL 15	8,23
18	L	Z ACJL 18	10,29
22	L	Z ACJL 22	11,76
28	L	Z ACJL 28	16,85
35	L	Z ACJL 35	24,95
42	L	Z ACJL 42	31,20
6	S	Z ACJS 6	5,15
8	S	Z ACJS 8	5,19
10	S	Z ACJS 10	5,85
12	S	Z ACJS 12	6,66
14	S	Z ACJS 14	8,10
16	S	Z ACJS 16	9,33
20	S	Z ACJS 20	12,32
25	S	Z ACJS 25	16,54
30	S	Z ACJS 30	21,70
38	S	Z ACJS 38	31,31

DIN 2353 Pipe fittings

Racores DIN 2353
Verschraubungen Din 2353
Raccords à bague DIN 2353

S.S.Cutting ring with joint ZACJ2

Anillos de corte con junta ZACJ2

Schneidring mit Dichtung ZACJ2

Bague Acier inox avec joint ZACJ2

**NEW**

ZACJ2 Equipped Nut

Tuerca equipada ZACJ2

ZACJ2 ausgestattete Mutter

Écrou équipé ZACJ2

**NEW**

TUBO PIPE	SERIE SERIES	Referencia Part n°	€
6	L	Z ACJ2L 6	10,62
8	L	Z ACJ2L 8	10,62
10	L	Z ACJ2L 10	11,39
12	L	Z ACJ2L 12	11,74
15	L	Z ACJ2L 15	17,47
18	L	Z ACJ2L 18	19,56
22	L	Z ACJ2L 22	24,18
28	L	Z ACJ2L 28	29,49
35	L	Z ACJ2L 35	45,42
42	L	Z ACJ2L 42	69,88
6	S	Z ACJ2S 6	11,18
8	S	Z ACJ2S 8	11,18
10	S	Z ACJ2S 10	11,88
12	S	Z ACJ2S 12	15,37
14	S	Z ACJ2S 14	17,47
16	S	Z ACJ2S 16	20,26
20	S	Z ACJ2S 20	26,55
25	S	Z ACJ2S 25	46,12
30	S	Z ACJ2S 30	55,90
38	S	Z ACJ2S 38	76,86

TUBO PIPE	SERIE SERIES	ROSCA THREAD	Referencia Part n°	€
6	L	M12X1.5	Z MJ2L 6	13,38
8	L	M14X1.5	Z MJ2L 8	13,15
10	L	M16X1.5	Z MJ2L 10	14,52
12	L	M18X1.5	Z MJ2L 12	15,49
15	L	M22X1.5	Z MJ2L 15	22,67
18	L	M26X1.5	Z MJ2L 18	26,46
22	L	M30X2	Z MJ2L 22	33,52
28	L	M36X2	Z MJ2L 28	41,24
35	L	M45X2	Z MJ2L 35	66,18
42	L	M52X2	Z MJ2L 42	106,39
6	S	M14X1.5	Z MJ2S 6	14,30
8	S	M16X1.5	Z MJ2S 8	14,56
10	S	M18X1.5	Z MJ2S 10	16,22
12	S	M20X1.5	Z MJ2S 12	19,92
14	S	M22X1.5	Z MJ2S 14	23,76
16	S	M24X1.5	Z MJ2S 16	27,18
20	S	M30X2	Z MJ2S 20	36,33
25	S	M36X2	Z MJ2S 25	75,57
30	S	M42X2	Z MJ2S 30	80,78
38	S	M52X2	Z MJ2S 38	125,94

PREVENTS LEAKS IN EQUIPMENT SUBJECT TO HIGH VIBRATIONS
EVITA FUGAS EN EQUIPAMIENTOS SOMETIDOS A ALTAS VIBRACIONES



ZACJ2

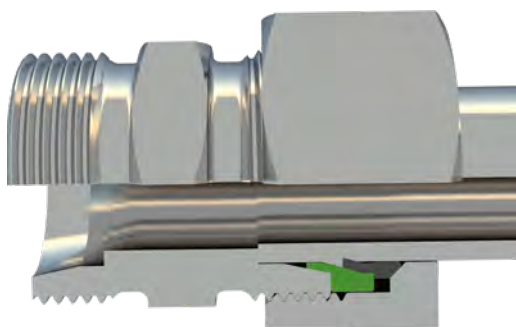

- ‡ Pressure rating up to 800 bar (PN)
- ‡ Reduction of tightening torques up to 25%
- ‡ Easier assembly
- ‡ Simple handling through functional nut

- ‡ Hasta una presión nominal (PN) de 800 bar
- ‡ Reducción de los pares de apriete en hasta 25%
- ‡ Un montaje aún más sencillo
- ‡ Sencillo manejo mediante tuerca funcional

DIN 2353 Pipe fittings

Racores DIN 2353

Verschraubungen Din 2353

Raccords à bague DIN 2353

Straight coupling

Racor unión recta tubo - tubo

Gerade Verschraubungen (G)

Raccord union double



TUBO PIPE	SERIE SERIES	Referencia Part n°	€	Referencia STA Part N° STA	€
4	LL	Z DLL 4	34,22	---	*
6	LL	Z DLL 6	30,00	---	*
8	LL	Z DLL 8	28,95	---	*
6	L	Z DL 6	16,65	Z STA DL 6	7,43
8	L	Z DL 8	17,44	Z STA DL 8	8,14
10	L	Z DL 10	19,36	Z STA DL 10	9,39
12	L	Z DL 12	21,43	Z STA DL 12	9,70
15	L	Z DL 15	30,44	Z STA DL 15	14,77
18	L	Z DL 18	36,35	Z STA DL 18	16,47
22	L	Z DL 22	48,06	Z STA DL 22	21,83
28	L	Z DL 28	70,88	Z STA DL 28	35,91
35	L	Z DL 35	111,31	Z STA DL 35	55,40
42	L	Z DL 42	176,78	Z STA DL 42	86,46
6	S	Z DS 6	19,42	Z STA DS 6	9,46
8	S	Z DS 8	20,08	Z STA DS 8	9,61
10	S	Z DS 10	25,50	Z STA DS 10	13,11
12	S	Z DS 12	29,53	Z STA DS 12	16,20
14	S	Z DS 14	37,87	Z STA DS 14	20,03
16	S	Z DS 16	37,65	Z STA DS 16	17,73
20	S	Z DS 20	56,77	Z STA DS 20	29,05
25	S	Z DS 25	115,40	Z STA DS 25	47,28
30	S	Z DS 30	142,58	Z STA DS 30	61,48
38	S	Z DS 38	194,36	Z STA DS 38	80,58

Equal elbow coupling

Racor unión en codo tubo - tubo

Winkel-Verschraubungen (W)

Raccord coude égal



TUBO PIPE	SERIE SERIES	Referencia Part n°	€	Referencia STA Part N° STA	€
4	LL	Z ELL 4	51,01	---	*
6	LL	Z ELL 6	45,30	---	*
8	LL	Z ELL 8	49,13	---	*
6	L	Z EL 6	27,57	Z STA EL 6	18,35
8	L	Z EL 8	28,86	Z STA EL 8	19,57
10	L	Z EL 10	32,51	Z STA EL 10	22,55
12	L	Z EL 12	35,53	Z STA EL 12	23,80
15	L	Z EL 15	46,98	Z STA EL 15	31,31
18	L	Z EL 18	62,46	Z STA EL 18	42,58
22	L	Z EL 22	86,74	Z STA EL 22	60,50
28	L	Z EL 28	127,41	Z STA EL 28	92,43
35	L	Z EL 35	202,28	Z STA EL 35	146,37
42	L	Z EL 42	316,97	Z STA EL 42	226,65
6	S	Z ES 6	31,63	Z STA ES 6	21,67
8	S	Z ES 8	34,90	Z STA ES 8	24,42
10	S	Z ES 10	37,42	Z STA ES 10	25,04
12	S	Z ES 12	41,60	Z STA ES 12	28,27
14	S	Z ES 14	52,90	Z STA ES 14	35,06
16	S	Z ES 16	59,99	Z STA ES 16	40,07
20	S	Z ES 20	89,62	Z STA ES 20	61,90
25	S	Z ES 25	159,93	Z STA ES 25	91,81
30	S	Z ES 30	222,75	Z STA ES 30	141,66
38	S	Z ES 38	317,89	Z STA ES 38	204,11

Straight reducing coupling

Racor unión recta en reducción
tubo - tubo

Gerade Reduzierschraubungen (GR)

Raccord union double en réduction



TUBO PIPE	PIPE	SERIE SERIES	Referencia Part n°	€	Referencia STA Part N° STA	€
8	6	L	Z DL 8-6	19,43	Z STA DL 8-6	10,04
10	6	L	Z DL 10-6	20,66	Z STA DL 10-6	10,94
10	8	L	Z DL 10-8	18,51	Z STA DL 10-8	8,75
12	6	L	Z DL 12-6	28,45	Z STA DL 12-6	17,85
12	8	L	Z DL 12-8	28,60	Z STA DL 12-8	16,58
12	10	L	Z DL 12-10	21,84	Z STA DL 12-10	10,87
15	6	L	Z DL 15-6	36,45	Z STA DL 15-6	23,88
15	8	L	Z DL 15-8	39,31	Z STA DL 15-8	26,71
15	10	L	Z DL 15-10	30,14	Z STA DL 15-10	17,20
15	12	L	Z DL 15-12	26,94	Z STA DL 15-12	13,12
18	8	L	Z DL 18-8	42,57	Z STA DL 18-8	27,86
18	10	L	Z DL 18-10	34,38	Z STA DL 18-10	19,33
18	12	L	Z DL 18-12	35,14	Z STA DL 18-12	19,21
18	15	L	Z DL 18-15	39,65	Z STA DL 18-15	21,75
22	12	L	Z DL 22-12	46,92	Z STA DL 22-12	27,81
22	15	L	Z DL 22-15	45,66	Z STA DL 22-15	24,58
22	18	L	Z DL 22-18	49,86	Z STA DL 22-18	26,68
28	22	L	Z DL 28-22	76,02	Z STA DL 28-22	45,29
35	28	L	Z DL 35-28	123,84	Z STA DL 35-28	78,27
42	28	L	Z DL 42-28	148,85	Z STA DL 42-28	86,07
42	35	L	Z DL 42-35	206,95	Z STA DL 42-35	133,71
8	6	S	Z DS 8-6	27,11	Z STA DS 8-6	16,77
10	6	S	Z DS 10-6	28,81	Z STA DS 10-6	17,52
10	8	S	Z DS 10-8	28,30	Z STA DS 10-8	18,55
12	6	S	Z DS 12-6	32,62	Z STA DS 12-6	20,85
12	8	S	Z DS 12-8	31,71	Z STA DS 12-8	19,68
12	10	S	Z DS 12-10	30,53	Z STA DS 12-10	17,55
14	10	S	Z DS 14-10	36,71	Z STA DS 14-10	21,47
16	10	S	Z DS 16-10	52,94	Z STA DS 16-10	36,67
16	12	S	Z DS 16-12	37,17	Z STA DS 16-12	20,43
16	14	S	Z DS 16-14	42,49	Z STA DS 16-14	23,49
20	10	S	Z DS 20-10	60,92	Z STA DS 20-10	40,74
20	12	S	Z DS 20-12	74,07	Z STA DS 20-12	53,42
20	14	S	Z DS 20-14	82,38	Z STA DS 20-14	59,47
20	16	S	Z DS 20-16	57,63	Z STA DS 20-16	33,69
25	16	S	Z DS 25-16	92,95	Z STA DS 25-16	48,80
25	20	S	Z DS 25-20	98,01	Z STA DS 25-20	49,97
30	20	S	Z DS 30-20	126,35	Z STA DS 30-20	71,82
30	25	S	Z DS 30-25	166,65	Z STA DS 30-25	91,92
38	25	S	Z DS 38-25	182,40	Z STA DS 38-25	91,32
38	30	S	Z DS 38-30	205,07	Z STA DS 38-30	107,51

DIN 2353 Pipe fittings

Racores DIN 2353
Verschraubungen Din 2353
Raccords à bague DIN 2353

Equal Tee

Racor unión en T tubo - tubo

T-Verschraubungen (T)

Raccord Té égal



Equal cross

Racor unión en cruz tubo - tubo

Kreuz-Verschraubungen (K)

Raccord croix égal



TUBO PIPE	SERIE SERIES	Referencia Part n°	€	Referencia STA Part N° STA	€
4	LL	Z TLL 4	65,92	---	*
6	LL	Z TLL 6	66,67	---	*
8	LL	Z TLL 8	72,82	---	*
6	L	Z TL 6	35,33	Z STA TL 6	21,56
8	L	Z TL 8	38,30	Z STA TL 8	24,42
10	L	Z TL 10	41,05	Z STA TL 10	26,17
12	L	Z TL 12	45,71	Z STA TL 12	28,17
15	L	Z TL 15	63,39	Z STA TL 15	39,95
18	L	Z TL 18	82,36	Z STA TL 18	52,61
22	L	Z TL 22	114,31	Z STA TL 22	75,02
28	L	Z TL 28	170,42	Z STA TL 28	118,02
35	L	Z TL 35	296,67	Z STA TL 35	212,87
42	L	Z TL 42	417,17	Z STA TL 42	281,75
6	S	Z TS 6	44,15	Z STA TS 6	29,28
8	S	Z TS 8	45,87	Z STA TS 8	30,22
10	S	Z TS 10	51,71	Z STA TS 10	33,20
12	S	Z TS 12	60,00	Z STA TS 12	40,07
14	S	Z TS 14	76,88	Z STA TS 14	50,18
16	S	Z TS 16	82,42	Z STA TS 16	52,61
20	S	Z TS 20	119,47	Z STA TS 20	77,95
25	S	Z TS 25	226,96	Z STA TS 25	124,84
30	S	Z TS 30	328,14	Z STA TS 30	206,56
38	S	Z TS 38	466,52	Z STA TS 38	295,91

TUBO PIPE	SERIE SERIES	Referencia Part n°	€	Referencia STA Part N° STA	€
6	L	Z KVL 6	70,20	Z STA KVL 6	51,88
8	L	Z KVL 8	71,41	Z STA KVL 8	52,94
10	L	Z KVL 10	94,35	Z STA KVL 10	74,54
12	L	Z KVL 12	91,77	Z STA KVL 12	68,42
15	L	Z KVL 15	137,66	Z STA KVL 15	106,45
18	L	Z KVL 18	155,70	Z STA KVL 18	116,07
22	L	Z KVL 22	192,30	Z STA KVL 22	139,96
28	L	Z KVL 28	223,20	Z STA KVL 28	153,38
35	L	Z KVL 35	556,50	Z STA KVL 35	444,81
42	L	Z KVL 42	798,30	Z STA KVL 42	617,78
6	S	Z KVS 6	79,44	Z STA KVS 6	59,64
8	S	Z KVS 8	91,10	Z STA KVS 8	70,27
10	S	Z KVS 10	118,78	Z STA KVS 10	94,14
12	S	Z KVS 12	136,55	Z STA KVS 12	110,01
14	S	Z KVS 14	181,21	Z STA KVS 14	145,65
16	S	Z KVS 16	196,60	Z STA KVS 16	156,89
20	S	Z KVS 20	215,25	Z STA KVS 20	159,93
25	S	Z KVS 25	311,62	Z STA KVS 25	175,50
30	S	Z KVS 30	419,80	Z STA KVS 30	257,74
38	S	Z KVS 38	674,76	Z STA KVS 38	447,32

DIN 2353 Pipe fittings

Racores DIN 2353

Verschraubungen Din 2353

Raccords à bague DIN 2353

Straight male stud coupling BSP cylindrical

Racor recto rosca cilíndrica BSP

Gerade Einschraubversch. BSP 60°
Innenkonus – GE-R

Raccord union simple gaz cylindrique mâle



TUBO PIPE	SERIE SERIES	ROSCA THREAD	Referencia Part n°	€	Referencia STA Part N° STA	€
6	LL	1/8" BSP	Z ALL 6 R 1/8	14,51	---	*
10	L	1/8" BSP	Z AL 10 R 1/8	14,80	---	*
15	L	3/4" BSP	Z AL 15 R 3/4	29,11	---	*
6	S	1/4" BSP	Z AS 6 R 1/4	18,51	Z STA AS 6 R 1/4	13,43
8	S	1/4" BSP	Z AS 8 R 1/4	15,10	Z STA AS 8 R 1/4	11,01
8	S	1/2" BSP	Z AS 8 R 1/2	27,25	---	*
10	S	1/4" BSP	Z AS 10 R 1/4	16,99	Z STA AS 10 R 1/4	12,16
10	S	3/8" BSP	Z AS 10 R 3/8	17,40	Z STA AS 10 R 3/8	13,34
38	S	1" 1/4 BSP	Z AS 38 R 1 1/4	127,89	Z STA AS 38 R 1 1/4	86,04

Until end of stock / Hasta fin de existencias / Bis zum Ende des Lagerbestandes / Jusqu'à la fin du stock

Straight male stud coupling Metric cylindrical with captive seal

Racor recto rosca cilíndrica Métrica con junta

Gerade metr. Einschraubversch. mit
Flachdichtung GE-M-EDRaccord union simple mâle cylindrique
Métrique avec joint plat

TUBO PIPE	SERIE SERIES	ROSCA THREAD	Referencia Part n°	€	Referencia STA Part N° STA	€
6	L	M10x1	Z AL 6 M 10X1 WD	12,70	Z STA AL 6 M 10X1 WD	8,03
8	L	M12x1.5	Z AL 8 M 12X1.5 WD	16,81	Z STA AL 8 M 12X1.5 WD	12,10
10	L	M12x1.5	Z AL 10 M 12X1.5 WD	27,86	Z STA AL 10 M 12X1.5 WD	22,82
10	L	M14x1.5	Z AL 10 M 14X1.5 WD	20,20	Z STA AL 10 M 14X1.5 WD	15,15
10	L	M16x1.5	Z AL 10 M 16X1.5 WD	22,62	Z STA AL 10 M 16X1.5 WD	17,57
12	L	M16x1.5	Z AL 12 M 16X1.5 WD	22,73	Z STA AL 12 M 16X1.5 WD	16,80
12	L	M18x1.5	Z AL 12 M 18X1.5 WD	23,67	Z STA AL 12 M 18X1.5 WD	17,74
12	L	M22x1.5	Z AL 12 M 22X1.5 WD	30,75	Z STA AL 12 M 22X1.5 WD	24,82
15	L	M18x1.5	Z AL 15 M 18X1.5 WD	33,13	Z STA AL 15 M 18X1.5 WD	25,23
18	L	M22x1.5	Z AL 18 M 22X1.5 WD	35,79	Z STA AL 18 M 22X1.5 WD	25,79
22	L	M26x1.5	Z AL 22 M 26X1.5 WD	43,43	Z STA AL 22 M 26X1.5 WD	30,25
28	L	M33x2	Z AL 28 M 33X2 WD	58,27	Z STA AL 28 M 33X2 WD	40,72
35	L	M42x2	Z AL 35 M 42X2 WD	129,80	Z STA AL 35 M 42X2 WD	101,79
42	L	M48x2	Z AL 42 M 48X2 WD	192,60	Z STA AL 42 M 48X2 WD	147,38
6	S	M12x1.5	Z AS 6 M 12X1.5 WD	28,37	Z STA AS 6 M 12X1.5 WD	23,33
6	S	M14x1.5	Z AS 6 M 14X1.5 WD	28,56	Z STA AS 6 M 14X1.5 WD	23,52
8	S	M14x1.5	Z AS 8 M 14X1.5 WD	30,05	Z STA AS 8 M 14X1.5 WD	24,75
10	S	M16x1.5	Z AS 10 M 16X1.5 WD	33,45	Z STA AS 10 M 16X1.5 WD	27,19
12	S	M14x1.5	Z AS 12 M 14X1.5 WD	27,63	Z STA AS 12 M 14X1.5 WD	20,91
12	S	M18x1.5	Z AS 12 M 18X1.5 WD	26,78	Z STA AS 12 M 18X1.5 WD	20,06
14	S	M20x1.5	Z AS 14 M 20X1.5 WD	44,97	Z STA AS 14 M 20X1.5 WD	35,98
16	S	M22x1.5	Z AS 16 M 22X1.5 WD	36,54	Z STA AS 16 M 22X1.5 WD	26,52
20	S	M27x2	Z AS 20 M 27X2 WD	46,21	Z STA AS 20 M 27X2 WD	32,29
25	S	M33x2	Z AS 25 M 33X2 WD	100,79	Z STA AS 25 M 33X2 WD	66,67
30	S	M42x2	Z AS 30 M 42X2 WD	140,62	Z STA AS 30 M 42X2 WD	100,01
38	S	M48x2	Z AS 38 M 48X2 WD	209,60	Z STA AS 38 M 48X2 WD	152,65

Straight male stud coupling UNF

Racor recto rosca UNF

Gerade Einschraubversch. UNF

Raccord union simple mâle UNF



TUBO PIPE	SERIE SERIES	ROSCA THREAD	Referencia Part n°	€	Referencia STA Part N° STA	€
8	L	7/16" UNF	Z AL 8 7/16 UNF	23,49	Z STA AL 8 7/16 UNF	18,78
10	L	7/16" UNF	Z AL 10 7/16 UNF	24,40	Z STA AL 10 7/16 UNF	19,35
12	L	3/4" UNF	Z AL 12 3/4 UNF	25,60	Z STA AL 12 3/4 UNF	19,67
12	L	9/16" UNF	Z AL 12 9/16 UNF	23,07	Z STA AL 12 9/16 UNF	17,14
15	L	3/4" UNF	Z AL 15 3/4 UNF	34,73	Z STA AL 15 3/4 UNF	26,83
18	L	7/8" UNF	Z AL 18 7/8 UNF	34,84	Z STA AL 18 7/8 UNF	24,84
22	L	1" 1/16 UNF	Z AL 22 1 1/16 UNF	42,93	Z STA AL 22 1 1/16 UNF	29,75
28	L	1" 5/16 UNF	Z AL 28 1 5/16 UNF	62,40	Z STA AL 28 1 5/16 UNF	44,85
35	L	1" 5/8 UNF	Z AL 35 1 5/8 UNF	110,77	Z STA AL 35 1 5/8 UNF	82,76
8	S	7/16" UNF	Z AS 8 7/16 UNF	22,54	Z STA AS 8 7/16 UNF	17,24
10	S	9/16" UNF	Z AS 10 9/16 UNF	25,70	Z STA AS 10 9/16 UNF	19,45
12	S	9/16" UNF	Z AS 12 9/16 UNF	26,65	Z STA AS 12 9/16 UNF	19,92
16	S	3/4" UNF	Z AS 16 3/4 UNF	37,75	Z STA AS 16 3/4 UNF	27,73
20	S	7/8" UNF	Z AS 20 7/8 UNF	51,81	Z STA AS 20 7/8 UNF	37,89
20	S	1" 1/16 UNF	Z AS 20 1 1/16 UNF	54,37	Z STA AS 20 1 1/16 UNF	40,45
25	S	1" 5/16 UNF	Z AS 25 1 5/16 UNF	92,51	Z STA AS 25 1 5/16 UNF	58,39
30	S	1" 5/16 UNF	Z AS 30 1 5/16 UNF	112,13	Z STA AS 30 1 5/16 UNF	71,52
38	S	1" 5/8 UNF	Z AS 38 1 5/8 UNF	185,51	Z STA AS 38 1 5/8 UNF	128,56

DIN 2353 Pipe fittings

Racores DIN 2353

Verschraubungen Din 2353

Raccords à bague DIN 2353

Straight male stud coupling NPT

Racor recto rosca cónica NPT

Gerade Einschraubversch.
NPT - EVGE-NPT

Raccord union simple mâle NPT



TUBO PIPE	SERIE SERIES	ROSCA THREAD	Referencia Part n°	€	Referencia STA Part N° STA	€
6	L	1/8"NPT	Z AKL 6 1/8 NPT	13,90	Z STA AKL 6 1/8 NPT	9,23
6	L	1/4"NPT	Z AKL 6 1/4 NPT	18,64	Z STA AKL 6 1/4 NPT	13,96
6	L	3/8"NPT	Z AKL 6 3/8 NPT	24,23	Z STA AKL 6 3/8 NPT	19,56
8	L	1/8"NPT	Z AKL 8 1/8 NPT	14,67	Z STA AKL 8 1/8 NPT	9,96
8	L	1/4"NPT	Z AKL 8 1/4 NPT	15,50	Z STA AKL 8 1/4 NPT	10,79
8	L	3/8"NPT	Z AKL 8 3/8 NPT	17,77	Z STA AKL 8 3/8 NPT	13,06
8	L	1/2"NPT	Z AKL 8 1/2 NPT	21,54	Z STA AKL 8 1/2 NPT	16,83
10	L	1/4"NPT	Z AKL 10 1/4 NPT	16,16	Z STA AKL 10 1/4 NPT	11,11
10	L	3/8"NPT	Z AKL 10 3/8 NPT	17,63	Z STA AKL 10 3/8 NPT	12,59
10	L	1/2"NPT	Z AKL 10 1/2 NPT	24,03	Z STA AKL 10 1/2 NPT	18,99
12	L	1/4"NPT	Z AKL 12 1/4 NPT	19,96	Z STA AKL 12 1/4 NPT	14,04
12	L	3/8"NPT	Z AKL 12 3/8 NPT	20,30	Z STA AKL 12 3/8 NPT	14,36
12	L	1/2"NPT	Z AKL 12 1/2 NPT	21,87	Z STA AKL 12 1/2 NPT	15,94
15	L	3/8"NPT	Z AKL 15 3/8 NPT	28,02	Z STA AKL 15 3/8 NPT	20,13
15	L	1/2"NPT	Z AKL 15 1/2 NPT	29,09	Z STA AKL 15 1/2 NPT	21,19
18	L	1/2"NPT	Z AKL 18 1/2 NPT	35,39	Z STA AKL 18 1/2 NPT	25,39
18	L	3/4"NPT	Z AKL 18 3/4 NPT	38,11	Z STA AKL 18 3/4 NPT	28,11
22	L	3/4"NPT	Z AKL 22 3/4 NPT	40,39	Z STA AKL 22 3/4 NPT	27,21
28	L	1"NPT	Z AKL 28 1 NPT	62,15	Z STA AKL 28 1 NPT	44,60
35	L	1 1/4"NPT	Z AKL 35 1 1/4 NPT	82,54	Z STA AKL 35 1 1/4 NPT	54,53
42	L	1 1/2"NPT	Z AKL 42 1 1/2 NPT	129,56	Z STA AKL 42 1 1/2 NPT	84,33
6	S	1/8"NPT	Z AKS 6 1/8 NPT	20,66	Z STA AKS 6 1/8 NPT	15,62
6	S	1/4"NPT	Z AKS 6 1/4 NPT	20,96	Z STA AKS 6 1/4 NPT	15,92
6	S	3/8"NPT	Z AKS 6 3/8 NPT	26,01	Z STA AKS 6 3/8 NPT	21,33
8	S	1/4"NPT	Z AKS 8 1/4 NPT	18,16	Z STA AKS 8 1/4 NPT	12,86
8	S	3/8"NPT	Z AKS 8 3/8 NPT	28,16	Z STA AKS 8 3/8 NPT	22,86
8	S	1/2"NPT	Z AKS 8 1/2 NPT	29,42	Z STA AKS 8 1/2 NPT	24,12
10	S	1/4"NPT	Z AKS 10 1/4 NPT	21,57	Z STA AKS 10 1/4 NPT	15,32
10	S	3/8"NPT	Z AKS 10 3/8 NPT	21,22	Z STA AKS 10 3/8 NPT	14,96
10	S	1/2"NPT	Z AKS 10 1/2 NPT	33,10	Z STA AKS 10 1/2 NPT	26,85
12	S	1/4"NPT	Z AKS 12 1/4 NPT	28,30	Z STA AKS 12 1/4 NPT	21,57
12	S	3/8"NPT	Z AKS 12 3/8 NPT	25,90	Z STA AKS 12 3/8 NPT	19,17
12	S	1/2"NPT	Z AKS 12 1/2 NPT	26,78	Z STA AKS 12 1/2 NPT	20,05
14	S	1/2"NPT	Z AKS 14 1/2 NPT	34,63	Z STA AKS 14 1/2 NPT	25,64
16	S	1/2"NPT	Z AKS 16 1/2 NPT	36,25	Z STA AKS 16 1/2 NPT	26,23
16	S	3/4"NPT	Z AKS 16 3/4 NPT	58,45	Z STA AKS 16 3/4 NPT	48,43
20	S	1/2"NPT	Z AKS 20 1/2 NPT	43,91	Z STA AKS 20 1/2 NPT	29,99
20	S	3/4"NPT	Z AKS 20 3/4 NPT	58,20	Z STA AKS 20 3/4 NPT	44,27
20	S	1"NPT	Z AKS 20 1 NPT	62,11	Z STA AKS 20 1 NPT	48,19
25	S	3/4"NPT	Z AKS 25 3/4 NPT	85,50	Z STA AKS 25 3/4 NPT	51,38
25	S	1"NPT	Z AKS 25 1 NPT	83,02	Z STA AKS 25 1 NPT	48,90
30	S	1"NPT	Z AKS 30 1 NPT	115,34	Z STA AKS 30 1 NPT	74,73
30	S	1 1/4"NPT	Z AKS 30 1 1/4 NPT	117,16	Z STA AKS 30 1 1/4 NPT	76,55
38	S	1 1/2"NPT	Z AKS 38 1 1/2 NPT	150,23	Z STA AKS 38 1 1/2 NPT	93,28

Straight male stud coupling BSPT

Racor recto rosca cónica BSPT

Gerade Einschraubversch.
kegelig - GE-BSPT

Raccord union simple mâle conique



TUBO PIPE	SERIE SERIES	ROSCA THREAD	Referencia Part n°	€	Referencia STA Part N° STA	€
6	LL	1/8" BSPT	Z AKLL 6 R 1/8	*	---	*
8	LL	1/8" BSPT	Z AKLL 8 R 1/8	*	---	*
6	L	1/8" BSPT	Z AKL 6 R 1/8	13,26	Z STA AKL 6 R 1/8	8,58
6	L	1/4" BSPT	Z AKL 6 R 1/4	14,75	Z STA AKL 6 R 1/4	10,07
8	L	1/8" BSPT	Z AKL 8 R 1/8	16,38	Z STA AKL 8 R 1/8	11,67
8	L	1/4" BSPT	Z AKL 8 R 1/4	15,33	Z STA AKL 8 R 1/4	10,62
6	L	3/8" BSPT	Z AKL 6 R 3/8	21,87	Z STA AKL 6 R 3/8	17,19
8	L	3/8" BSPT	Z AKL 8 R 3/8	18,53	Z STA AKL 8 R 3/8	13,82
10	L	1/4" BSPT	Z AKL 10 R 1/4	15,67	Z STA AKL 10 R 1/4	10,63
10	L	3/8" BSPT	Z AKL 10 R 3/8	15,29	Z STA AKL 10 R 3/8	10,25
10	L	1/2" BSPT	Z AKL 10 R 1/2	20,21	Z STA AKL 10 R 1/2	15,16
12	L	1/4" BSPT	Z AKL 12 R 1/4	18,23	Z STA AKL 12 R 1/4	12,30
12	L	3/8" BSPT	Z AKL 12 R 3/8	18,35	Z STA AKL 12 R 3/8	12,42
12	L	1/2" BSPT	Z AKL 12 R 1/2	20,75	Z STA AKL 12 R 1/2	14,82
15	L	3/8" BSPT	Z AKL 15 R 3/8	27,05	Z STA AKL 15 R 3/8	19,15
15	L	1/2" BSPT	Z AKL 15 R 1/2	25,18	Z STA AKL 15 R 1/2	17,29
18	L	1/2" BSPT	Z AKL 18 R 1/2	29,29	Z STA AKL 18 R 1/2	19,29
22	L	3/4" BSPT	Z AKL 22 R 3/4	37,54	Z STA AKL 22 R 3/4	24,36
28	L	1" BSPT	Z AKL 28 R 1	62,40	Z STA AKL 28 R 1	44,85
35	L	1 1/4" BSPT	Z AKL 35 R 1 1/4	83,00	Z STA AKL 35 R 1 1/4	54,98
42	L	1 1/4" BSPT	Z AKL 42 R 1 1/4	121,15	Z STA AKL 42 R 1 1/4	75,93
6	S	1/4" BSPT	Z AKS 6 R 1/4	17,81	Z STA AKS 6 R 1/4	12,77
8	S	1/4" BSPT	Z AKS 8 R 1/4	17,18	Z STA AKS 8 R 1/4	11,88
10	S	3/8" BSPT	Z AKS 10 R 3/8	30,40	Z STA AKS 10 R 3/8	24,15
14	S	1/2" BSPT	Z AKS 14 R 1/2	55,22	Z STA AKS 14 R 1/2	46,24
16	S	1/2" BSPT	Z AKS 16 R 1/2	33,98	Z STA AKS 16 R 1/2	23,96
20	S	3/4" BSPT	Z AKS 20 R 3/4	48,26	Z STA AKS 20 R 3/4	34,34
25	S	1" BSPT	Z AKS 25 R 1	84,33	Z STA AKS 25 R 1	50,20
30	S	1 1/4" BSPT	Z AKS 30 R 1 1/4	202,69	Z STA AKS 30 R 1 1/4	162,08

Straight male stud coupling Metric

Racor recto rosca cónica Métrica

Gerade Einschraubversch. metr. kon.- EVGE-M
(KEG)

Raccord union simple mâle Métrique conique



TUBO PIPE	SERIE SERIES	ROSCA THREAD	Referencia Part n°	€
6	LL	M10X1	Z AKLL 6 M10X1	21,06
6	L	M10X1	Z AKL 6 M 10X1	21,24
8	L	M12X1.5	Z AKL 8 M 12X1.5	27,37
10	L	M14X1.5	Z AKL 10 M 14X1.5	30,49
12	L	M16X1.5	Z AKL 12 M 16X1.5	33,34
15	L	M18X1.5	Z AKL 15 M 18X1.5	45,62
18	L	M22X1.5	Z AKL 18 M 22X1.5	59,65
22	L	M26X1.5	Z AKL 22 M 26X1.5	38,36

DIN 2353 Pipe fittings

Racores DIN 2353
Verschraubungen Din 2353
Raccords à bague DIN 2353

Male stud elbow BSPT

Racor en codo rosca cónica BSPT

W-Einschraubverschr. BSPT
kon. - WE-R (KEG)

Raccordo union coude mâle gaz conique



Male stud elbow NPT

Racor en codo rosca cónica NPT

W-Einschraubverschr. NPT - WE-NPT kon

Raccordo union coude mâle NPT



TUBO PIPE	SERIE SERIES	ROSCA THREAD	Referencia Part n°	€	Referencia STA Part N° STA	€
6	LL	1/8" BSPT	Z CKLL 6 R 1/8	21,67	---	*
6	L	1/8" BSPT	Z CKL 6 R 1/8	18,98	Z STA CKL 6 R 1/8	14,30
6	L	1/4" BSPT	Z CKL 6 R 1/4	18,49	Z STA CKL 6 R 1/4	13,82
8	L	1/8" BSPT	Z CKL 8 R 1/8	22,12	Z STA CKL 8 R 1/8	17,41
8	L	1/4" BSPT	Z CKL 8 R 1/4	21,17	Z STA CKL 8 R 1/4	16,47
8	L	3/8" BSPT	Z CKL 8 R 3/8	27,70	Z STA CKL 8 R 3/8	22,99
8	L	1/2" BSPT	Z CKL 8 R 1/2	36,42	Z STA CKL 8 R 1/2	31,72
10	L	1/8" BSPT	Z CKL 10 R 1/8	32,59	Z STA CKL 10 R 1/8	27,55
10	L	1/4" BSPT	Z CKL 10 R 1/4	22,52	Z STA CKL 10 R 1/4	17,48
10	L	3/8" BSPT	Z CKL 10 R 3/8	26,77	Z STA CKL 10 R 3/8	21,72
10	L	1/2" BSPT	Z CKL 10 R 1/2	26,55	Z STA CKL 10 R 1/2	21,50
12	L	1/4" BSPT	Z CKL 12 R 1/4	26,48	Z STA CKL 12 R 1/4	20,55
12	L	3/8" BSPT	Z CKL 12 R 3/8	27,28	Z STA CKL 12 R 3/8	21,35
12	L	1/2" BSPT	Z CKL 12 R 1/2	32,50	Z STA CKL 12 R 1/2	26,57
15	L	3/8" BSPT	Z CKL 15 R 3/8	45,30	Z STA CKL 15 R 3/8	37,41
15	L	1/2" BSPT	Z CKL 15 R 1/2	37,51	Z STA CKL 15 R 1/2	29,61
18	L	1/2" BSPT	Z CKL 18 R 1/2	47,43	Z STA CKL 18 R 1/2	37,43
22	L	3/4" BSPT	Z CKL 22 R 3/4	80,74	Z STA CKL 22 R 3/4	67,56
28	L	1" BSPT	Z CKL 28 R 1	160,44	Z STA CKL 28 R 1	142,89
35	L	1 1/4" BSPT	Z CKL 35 R 1 1/4	278,98	Z STA CKL 35 R 1 1/4	250,96
6	S	1/4" BSPT	Z CKS 6 R 1/4	26,20	Z STA CKS 6 R 1/4	21,16
8	S	1/4" BSPT	Z CKS 8 R 1/4	28,72	Z STA CKS 8 R 1/4	23,42
8	S	3/8" BSPT	Z CKS 8 R 3/8*	48,25	---	*
8	S	1/2" BSPT	Z CKS 8 R 1/2	34,51	Z STA CKS 8 R 1/2	29,21
10	S	1/4" BSPT	Z CKS 10 R 1/4	36,98	Z STA CKS 10 R 1/4	30,73
10	S	3/8" BSPT	Z CKS 10 R 3/8	32,03	Z STA CKS 10 R 3/8	25,78
10	S	1/2" BSPT	Z CKS 10 R 1/2*	50,89	---	*
12	S	3/8" BSPT	Z CKS 12 R 3/8	37,78	Z STA CKS 12 R 3/8	31,05
14	S	1/2" BSPT	Z CKS 14 R 1/2	46,63	Z STA CKS 14 R 1/2	37,65
16	S	1/2" BSPT	Z CKS 16 R 1/2	55,56	Z STA CKS 16 R 1/2	45,54
20	S	3/4" BSPT	Z CKS 20 R 3/4	86,33	Z STA CKS 20 R 3/4	72,40
25	S	1" BSPT	Z CKS 25 R 1	158,60	Z STA CKS 25 R 1	124,48
30	S	1 1/4" BSPT	Z CKS 30 R 1 1/4	309,05	Z STA CKS 30 R 1 1/4	268,44
38	S	1 1/2" BSPT	Z CKS 38 R 1 1/2	413,96	Z STA CKS 38 R 1 1/2	357,01

*Until end of stock / Hasta fin de existencias / Bis zum Ende des Lagerbestandes / Jusqu'à la fin du stock

90° Adjustable male stud elbow BSP

Racor en codo orientable BSP

Einstellbare W-Verschr. BSP - SWVE-M-R

Coude orientable mâle BSP



TUBO PIPE	SERIE SERIES	ROSCA THREAD	Referencia Part n°	€	Referencia STA Part N° STA	€
6	L	1/8" BSP	Z WEE 6L R 1/8	24,15	Z STA WEE 6L R 1/8	19,47
8	L	1/4" BSP	Z WEE 8L R 1/4	33,35	Z STA WEE 8L R 1/4	28,64
10	L	1/4" BSP	Z WEE 10L R 1/4	35,88	Z STA WEE 10L R 1/4	30,84
12	L	3/8" BSP	Z WEE 12L R 3/8	47,64	Z STA WEE 12L R 3/8	41,71
15	L	1/2" BSP	Z WEE 15L R 1/2	88,92	Z STA WEE 15L R 1/2	81,02
18	L	1/2" BSP	Z WEE 18L R 1/2	93,97	Z STA WEE 18L R 1/2	83,97
22	L	3/4" BSP	Z WEE 22L R 3/4	147,68	Z STA WEE 22L R 3/4	134,50
6	S	1/4" BSP	Z WEE 6S R 1/4	27,26	Z STA WEE 6S R 1/4	22,22
8	S	1/4" BSP	Z WEE 8S R 1/4	38,29	Z STA WEE 8S R 1/4	32,99
10	S	3/8" BSP	Z WEE 10S R 3/8	51,97	Z STA WEE 10S R 3/8	45,72
12	S	3/8" BSP	Z WEE 12S R 3/8	63,25	Z STA WEE 12S R 3/8	56,52
16	S	1/2" BSP	Z WEE 16S R 1/2	102,38	Z STA WEE 16S R 1/2	92,36
20	S	3/4" BSP	Z WEE 20S R 3/4	125,52	Z STA WEE 20S R 3/4	111,60
25	S	1" BSP	Z WEE 25S R 1	241,76	Z STA WEE 25S R 1	207,64

Male stud elbow metrical conical

Racor en codo rosca cónica Métrica

W-Einschraubverschr. metr. kon. - WE-M (KEG)

Raccordo équerre mâle métrique



TUBO PIPE	SERIE SERIES	ROSCA THREAD	Referencia Part n°	€
6	L	M10X1	Z CKL 6 M 10X1	34,22
8	L	M12X1.5	Z CKL 8 M 12X1.5	44,10
10	L	M14X1.5	Z CKL 10 M 14X1.5	47,52
12	L	M16X1.5	Z CKL 12 M 16X1.5	55,16
15	L	M18X1.5	Z CKL 15 M 18X1.5	77,01
18	L	M22X1.5	Z CKL 18 M 22X1.5	88,61
6	S	M12X1.5	Z CKS 6 M 12X1.5	35,64
8	S	M14X1.5	Z CKS 8 M 14X1.5	63,95
10	S	M16X1.5	Z CKS 10 M 16X1.5	66,13
12	S	M18X1.5	Z CKS 12 M 18X1.5	67,68
14	S	M20X1.5	Z CKS 14 M 20X1.5	69,30
16	S	M22X1.5	Z CKS 16 M 22X1.5	100,84

DIN 2353 Pipe fittings

Racores DIN 2353

Verschraubungen Din 2353

Raccords à bague DIN 2353

Male stud barrel TEE BSPT

Racor en L rosca cónica BSPT

L-Einschraubverschr. BSPT kon. (LR)

Raccord TÊ mâle gaz conique latéral



TUBO PIPE	SERIE SERIES	ROSCA THREAD	Referencia Part n°	€
6	L	1/8" BSPT	Z LKL 6 R 1/8	61,42
8	L	1/4" BSPT	Z LKL 8 R 1/4	64,91
10	L	1/4" BSPT	Z LKL 10 R 1/4	69,65
12	L	3/8" BSPT	Z LKL 12 R 3/8	73,71
15	L	1/2" BSPT	Z LKL 15 R 1/2	103,52
18	L	1/2" BSPT	Z LKL 18 R 1/2	170,54
6	S	1/4" BSPT	Z LKS 6 R 1/4	66,80
8	S	1/4" BSPT	Z LKS 8 R 1/4	73,92
10	S	3/8" BSPT	Z LKS 10 R 3/8	87,04
12	S	3/8" BSPT	Z LKS 12 R 3/8	92,79
14	S	1/2" BSPT	Z LKS 14 R 1/2	114,05
16	S	1/2" BSPT	Z LKS 16 R 1/2	143,87

Male stud barrel TEE Metric

Racor en L rosca cónica Métrica

L-Einschraubverschr. metr. kon. (LM)

Raccord Tê mâle Métrique latéral



TUBO PIPE	SERIE SERIES	ROSCA THREAD	Referencia Part n°	€
6	L	M10X1	Z LKL 6 M 10X1	*
8	L	M12X1.5	Z LKL 8 M 12X1.5	*
10	L	M14X1.5	Z LKL 10 M 14X1.5	*
12	L	M16X1.5	Z LKL 12 M 16X1.5	*
15	L	M18X1.5	Z LKL 15 M 18X1.5	*
18	L	M22X1.5	Z LKL 18 M 22X1.5	*
6	S	M12X1.5	Z LKS 6 M 12X1.5	*
8	S	M14X1.5	Z LKS 8 M 14X1.5	*
10	S	M16X1.5	Z LKS 10 M 16X1.5	*
12	S	M18X1.5	Z LKS 12 M 18X1.5	*
14	S	M20X1.5	Z LKS 14 M 20X1.5	*
16	S	M22X1.5	Z LKS 16 M 22X1.5	*

Male stud branch TEE BSPT

Racor en T rosca cónica BSPT

T-Einschraubverschr. BSPT kon. (TR)

Raccord TÊ mâle gaz conique au centre



TUBO PIPE	SERIE SERIES	ROSCA THREAD	Referencia Part n°	€
6	L	1/8" BSPT	Z FKL 6 R 1/8	24,53
8	L	1/8" BSPT	Z FKL 8 R 1/8*	36,50
8	L	1/4" BSPT	Z FKL 8 R 1/4	37,29
10	L	1/4" BSPT	Z FKL 10 R 1/4	43,62
12	L	3/8" BSPT	Z FKL 12 R 3/8	51,04
15	L	1/2" BSPT	Z FKL 15 R 1/2	57,39
18	L	1/2" BSPT	Z FKL 18 R 1/2	133,37
6	S	1/4" BSPT	Z FKS 6 R 1/4	43,70
8	S	1/4" BSPT	Z FKS 8 R 1/4	77,21
10	S	3/8" BSPT	Z FKS 10 R 3/8	78,97
12	S	3/8" BSPT	Z FKS 12 R 3/8	50,71
14	S	1/2" BSPT	Z FKS 14 R 1/2	122,83

*Until end of stock / Hasta fin de existencias / Bis zum Ende des Lagerbestandes / Jusqu'à la fin du stock

Male stud branch TEE Metrical

Racor en T rosca cónica Métrica

T-Einschraubverschr. metr. kon. (TM)

Raccord TÊ mâle Métrique au centre



TUBO PIPE	SERIE SERIES	ROSCA THREAD	Referencia Part n°	€
6	L	M10X1	Z FKL 6 M 10X1	*
8	L	M12X1.5	Z FKL 8 M 12X1.5	*
10	L	M14X1.5	Z FKL 10 M 14X1.5	*
12	L	M16X1.5	Z FKL 12 M 16X1.5	*
15	L	M18X1.5	Z FKL 15 M 18X1.5	*
6	S	M12X1.5	Z FKS 6 M 12X1.5	*
8	S	M14X1.5	Z FKS 8 M 14X1.5	*
10	S	M16X1.5	Z FKS 10 M 16X1.5	*
12	S	M18X1.5	Z FKS 12 M 18X1.5	*
14	S	M20X1.5	Z FKS 14 M 20X1.5	*
16	S	M22X1.5	Z FKS 16 M 22X1.5	*

DIN 2353 Pipe fittings

Racores DIN 2353
Verschraubungen Din 2353
Raccords à bague DIN 2353

Standpipe reducer swivel female (light series)

Racor de reducción con TL Métrica (serie ligera)

Metr. Reduzierschraubung
(Leichte Baureihe)

Raccord union simple femelle tournante
Métrique (série légère)



TUBO PIPE	SERIE PIPE	SERIE SERIES	Referencia Part n°	€	Referencia Part n°	€
8	6	L	Z KORL 8-6 TLM	27,03	Z STA KORL 8-6 TLM	22,36
10	6	L	Z KORL 10-6 TLM	27,36	Z STA KORL 10-6 TLM	22,69
10	8	L	Z KORL 10-8 TLM	24,54	Z STA KORL 10-8 TLM	19,83
12	6	L	Z KORL 12-6 TLM	32,85	Z STA KORL 12-6 TLM	28,17
12	8	L	Z KORL 12-8 TLM	24,44	Z STA KORL 12-8 TLM	19,73
12	10	L	Z KORL 12-10 TLM	29,51	Z STA KORL 12-10 TLM	24,47
15	6	L	Z KORL 15-6 TLM	39,11	Z STA KORL 15-6 TLM	34,44
15	8	L	Z KORL 15-8 TLM	33,95	Z STA KORL 15-8 TLM	29,24
15	10	L	Z KORL 15-10 TLM	37,12	Z STA KORL 15-10 TLM	32,08
15	12	L	Z KORL 15-12 TLM	28,80	Z STA KORL 15-12 TLM	22,87
18	8	L	Z KORL 18-8 TLM	43,85	Z STA KORL 18-8 TLM	39,14
18	10	L	Z KORL 18-10 TLM	37,22	Z STA KORL 18-10 TLM	32,18
18	12	L	Z KORL 18-12 TLM	39,36	Z STA KORL 18-12 TLM	33,43
18	15	L	Z KORL 18-15 TLM	44,93	Z STA KORL 18-15 TLM	37,03
22	10	L	Z KORL 22-10 TLM	41,05	Z STA KORL 22-10 TLM	36,00
22	12	L	Z KORL 22-12 TLM	40,70	Z STA KORL 22-12 TLM	34,77
22	15	L	Z KORL 22-15 TLM	46,42	Z STA KORL 22-15 TLM	38,52
22	18	L	Z KORL 22-18 TLM	54,60	Z STA KORL 22-18 TLM	44,60
28	10	L	Z KORL 28-10 TLM	72,44	Z STA KORL 28-10 TLM	67,39
28	12	L	Z KORL 28-12 TLM	61,15	Z STA KORL 28-12 TLM	55,22
28	15	L	Z KORL 28-15 TLM	92,41	Z STA KORL 28-15 TLM	84,52
28	18	L	Z KORL 28-18 TLM	60,51	Z STA KORL 28-18 TLM	50,51
28	22	L	Z KORL 28-22 TLM	67,35	Z STA KORL 28-22 TLM	54,17
35	12	L	Z KORL 35-12 TLM	100,15	Z STA KORL 35-12 TLM	94,22
35	22	L	Z KORL 35-22 TLM	110,23	Z STA KORL 35-22 TLM	97,05
35	28	L	Z KORL 35-28 TLM	97,00	Z STA KORL 35-28 TLM	79,45
42	22	L	Z KORL 42-22 TLM	186,89	Z STA KORL 42-22 TLM	173,71
42	28	L	Z KORL 42-28 TLM	137,80	Z STA KORL 42-28 TLM	120,25
42	35	L	Z KORL 42-35 TLM	141,47	Z STA KORL 42-35 TLM	113,46

Standpipe reducer swivel female (heavy series)

Racor de reducción con TL Métrica (serie pesada)

Metr. Reduzierschraubung (Schwere
Baureihe)

Raccord union simple femelle tournante
Métrique (série lourde)



TUBO PIPE	SERIE PIPE	SERIE SERIES	Referencia Part n°	€	Referencia Part n°	€
8	6	S	Z KORS 8-6 TLM	43,10	Z STA KORS 8-6 TLM	38,06
10	6	S	Z KORS 10-6 TLM	46,50	Z STA KORS 10-6 TLM	41,46
10	8	S	Z KORS 10-8 TLM	46,28	Z STA KORS 10-8 TLM	40,98
12	6	S	Z KORS 12-6 TLM	46,97	Z STA KORS 12-6 TLM	41,92
12	8	S	Z KORS 12-8 TLM	42,99	Z STA KORS 12-8 TLM	37,69
12	10	S	Z KORS 12-10 TLM	50,92	Z STA KORS 12-10 TLM	44,67
14	10	S	Z KORS 14-10 TLM	56,15	Z STA KORS 14-10 TLM	49,89
14	12	S	Z KORS 14-12 TLM	55,41	Z STA KORS 14-12 TLM	48,68
16	6	S	Z KORS 16-6 TLM	66,26	Z STA KORS 16-6 TLM	61,22
16	8	S	Z KORS 16-8 TLM	64,77	Z STA KORS 16-8 TLM	59,47
16	10	S	Z KORS 16-10 TLM	62,24	Z STA KORS 16-10 TLM	55,98
16	12	S	Z KORS 16-12 TLM	48,07	Z STA KORS 16-12 TLM	41,34
20	8	S	Z KORS 20-8 TLM	81,64	Z STA KORS 20-8 TLM	76,34
20	10	S	Z KORS 20-10 TLM	81,71	Z STA KORS 20-10 TLM	75,46
20	12	S	Z KORS 20-12 TLM	60,39	Z STA KORS 20-12 TLM	53,66
20	14	S	Z KORS 20-14 TLM	82,70	Z STA KORS 20-14 TLM	73,71
20	16	S	Z KORS 20-16 TLM	70,50	Z STA KORS 20-16 TLM	60,48
25	12	S	Z KORS 25-12 TLM	103,23	Z STA KORS 25-12 TLM	96,50
25	16	S	Z KORS 25-16 TLM	109,85	Z STA KORS 25-16 TLM	99,83
25	20	S	Z KORS 25-20 TLM	119,04	Z STA KORS 25-20 TLM	105,11
30	16	S	Z KORS 30-16 TLM	151,97	Z STA KORS 30-16 TLM	141,95
30	20	S	Z KORS 30-20 TLM	133,51	Z STA KORS 30-20 TLM	119,59
30	25	S	Z KORS 30-25 TLM	174,85	Z STA KORS 30-25 TLM	140,72
38	20	S	Z KORS 38-20 TLM	170,85	Z STA KORS 38-20 TLM	156,92
38	25	S	Z KORS 38-25 TLM	193,18	Z STA KORS 38-25 TLM	159,06
38	30	S	Z KORS 38-30 TLM	251,18	Z STA KORS 38-30 TLM	210,57

DIN 2353 Pipe fittings

Racoeres DIN 2353

Verschraubungen Din 2353

Raccords à bague DIN 2353

Male-female reducing adaptor BSP cylindrical with flat seal

Reducción con rosca M-HF BSP con junta plana

Reduzierstück m - w fest BSP zyl. mit Flachdichtung

Raccord réduction mâle gaz-fem gaz avec joint plat



ROSCA (H) THREAD (F)	ROSCA (M) THREAD (M)	Referencia Part n°	€
1/4" BSP	1/8" BSP	Z RI-R 1/8 R 1/4WD	13,51
1/8" BSP	1/4" BSP	Z RI-R 1/4 R 1/8WD	13,02
3/8" BSP	1/4" BSP	Z RI-R 1/4 R 3/8WD	17,16
1/2" BSP	1/4" BSP	Z RI-R 1/4 R 1/2WD	25,23
1/8" BSP	3/8" BSP	Z RI-R 3/8 R 1/8WD	19,99
1/4" BSP	3/8" BSP	Z RI-R 3/8 R 1/4WD	18,65
1/2" BSP	3/8" BSP	Z RI-R 3/8 R 1/2WD	24,72
3/4" BSP	3/8" BSP	Z RI-R 3/8 R 3/4WD	39,52
1/8" BSP	1/2" BSP	Z RI-R 1/2 R 1/8WD	25,79
1/4" BSP	1/2" BSP	Z RI-R 1/2 R 1/4WD	12,52
3/8" BSP	1/2" BSP	Z RI-R 1/2 R 3/8WD	17,16
3/4" BSP	1/2" BSP	Z RI-R 1/2 R 3/4WD	22,43
1/4" BSP	3/4" BSP	Z RI-R 3/4 R 1/4WD	19,85
3/8" BSP	3/4" BSP	Z RI-R 3/4 R 3/8WD	25,39
1/2" BSP	3/4" BSP	Z RI-R 3/4 R 1/2WD	26,00
1" BSP	3/4" BSP	Z RI-R 3/4 R 1WD	42,48
1/4" BSP	1" BSP	Z RI-R 1 R 1/4WD	39,30
3/8" BSP	1" BSP	Z RI-R 1 R 3/8WD	28,81
1/2" BSP	1" BSP	Z RI-R 1 R 1/2WD	27,79
3/4" BSP	1" BSP	Z RI-R 1 R 3/4WD	43,62
1"1/4 BSP	1" BSP	Z RI-R 1 R 1 1/4WD	170,20
1/2" BSP	1"1/4 BSP	Z RI-R 1 1/4 R 1/2WD	46,84
3/4" BSP	1"1/4 BSP	Z RI-R 1 1/4 R 3/4WD	47,43
1" BSP	1"1/4 BSP	Z RI-R 1 1/4 R 1WD	69,98
1"1/2 BSP	1"1/4 BSP	Z RI-R 1 1/4 R 1 1/2WD	193,02
1/2" BSP	1"1/2 BSP	Z RI-R 1 1/2 R 1/2WD	64,68
3/4" BSP	1"1/2 BSP	Z RI-R 1 1/2 R 3/4WD	64,97
1" BSP	1"1/2 BSP	Z RI-R 1 1/2 R 1WD	62,55
1"1/4 BSP	1"1/2 BSP	Z RI-R 1 1/2 R 1 1/4WD	87,95
2" BSP	1"1/2 BSP	Z RI-R 1 1/2 R 2WD	167,55
1"1/2 BSP	2" BSP	Z RI-R 2 R 1 1/2WD	147,66

DIN 2353 Pipe fittings

Racores DIN 2353
Verschraubungen Din 2353
Raccords à bague DIN 2353

Adjustable stud elbow with nut and ring

Racor en codo regulable con tuerca y anillo

Einstellbarere metr. W-Verschraubung

Raccord coude orientable tube lisse équipé



TUBO PIPE	SERIE SERIES	Referencia Part n°	€	Referencia STA Part N° STA	€
6	L	Z EEL 6 CTA	26,95	Z STA EEL 6 CTA	24,75
15	L	Z EEL 15 CTA	49,49	Z STA EEL 15 CTA	43,64
35	L	Z EEL 35 CTA	179,35	Z STA EEL 35 CTA	160,43
6	S	Z EES 6 CTA	25,47	Z STA EES 6 CTA	21,20
16	S	Z EES 16 CTA	58,57	Z STA EES 16 CTA	53,57

Until end of stock / Hasta fin de existencias / Bis zum Ende des Lagerbestandes / Jusqu'à la fin du stock

Adjustable stud elbow with o'ring

Racor en codo regulable TL Métrica

Einstellbarere metr. W-Verschraubung
mit O-Ring

Raccord coude orientable Métrique avec o'ring



TUBO PIPE	SERIE SERIES	Referencia Part n°	€	Referencia STA Part N° STA	€
6	L	Z EEL 6 TLM	26,23	Z STA EEL 6 TLM	21,55
8	L	Z EEL 8 TLM	28,01	Z STA EEL 8 TLM	23,30
10	L	Z EEL 10 TLM	28,92	Z STA EEL 10 TLM	23,87
12	L	Z EEL 12 TLM	36,44	Z STA EEL 12 TLM	30,51
15	L	Z EEL 15 TLM	48,70	Z STA EEL 15 TLM	40,81
18	L	Z EEL 18 TLM	67,55	Z STA EEL 18 TLM	57,55
22	L	Z EEL 22 TLM	86,94	Z STA EEL 22 TLM	73,76
28	L	Z EEL 28 TLM	129,95	Z STA EEL 28 TLM	112,40
35	L	Z EEL 35 TLM	177,92	Z STA EEL 35 TLM	149,91
42	L	Z EEL 42 TLM	382,34	Z STA EEL 42 TLM	337,12
6	S	Z EES 6 TLM	38,25	Z STA EES 6 TLM	33,21
8	S	Z EES 8 TLM	39,06	Z STA EES 8 TLM	33,76
10	S	Z EES 10 TLM	40,44	Z STA EES 10 TLM	34,19
12	S	Z EES 12 TLM	52,23	Z STA EES 12 TLM	45,50
14	S	Z EES 14 TLM	66,22	Z STA EES 14 TLM	57,24
16	S	Z EES 16 TLM	65,68	Z STA EES 16 TLM	55,66
20	S	Z EES 20 TLM	95,44	Z STA EES 20 TLM	81,52
25	S	Z EES 25 TLM	161,46	Z STA EES 25 TLM	127,34
30	S	Z EES 30 TLM	213,16	Z STA EES 30 TLM	172,55
38	S	Z EES 38 TLM	346,58	Z STA EES 38 TLM	289,63

Adjustable stud branch TEE with o'ring

Racor en T regulable TL Métrica

Einstellbare T-Verschraubung T-Form

Raccord TÉ orientable Métrique avec o'ring



TUBO PIPE	SERIE SERIES	Referencia Part n°	€	Referencia STA Part N° STA	€
6	L	Z TEL 6 TLM	34,48	Z STA TEL 6 TLM	25,26
8	L	Z TEL 8 TLM	37,10	Z STA TEL 8 TLM	27,81
10	L	Z TEL 10 TLM	40,29	Z STA TEL 10 TLM	30,32
12	L	Z TEL 12 TLM	47,19	Z STA TEL 12 TLM	35,46
15	L	Z TEL 15 TLM	70,87	Z STA TEL 15 TLM	55,20
18	L	Z TEL 18 TLM	121,76	Z STA TEL 18 TLM	101,88
22	L	Z TEL 22 TLM	138,10	Z STA TEL 22 TLM	111,87
28	L	Z TEL 28 TLM	195,68	Z STA TEL 28 TLM	160,71
35	L	Z TEL 35 TLM	339,18	Z STA TEL 35 TLM	283,27
42	L	Z TEL 42 TLM	441,68	Z STA TEL 42 TLM	351,36
6	S	Z TES 6 TLM	53,69	Z STA TES 6 TLM	43,74
8	S	Z TES 8 TLM	48,55	Z STA TES 8 TLM	38,07
10	S	Z TES 10 TLM	56,51	Z STA TES 10 TLM	44,13
12	S	Z TES 12 TLM	60,52	Z STA TES 12 TLM	47,19
14	S	Z TES 14 TLM	96,74	Z STA TES 14 TLM	78,90
16	S	Z TES 16 TLM	108,44	Z STA TES 16 TLM	88,52
20	S	Z TES 20 TLM	139,71	Z STA TES 20 TLM	111,99
25	S	Z TES 25 TLM	225,84	Z STA TES 25 TLM	157,72
30	S	Z TES 30 TLM	311,23	Z STA TES 30 TLM	230,14
38	S	Z TES 38 TLM	467,64	Z STA TES 38 TLM	353,86

Adjustable stud barrel TEE with o'ring

Racor en T regulable TL Métrica

Einstellbare T-Verschraubung L-Form

Raccord TÉ orientable renversé Métrique
avec o'ring



TUBO PIPE	SERIE SERIES	ROSCA THREAD	Referencia Part n°	€	Referencia STA Part N° STA	€
6	L	M12X1.5	Z LEL 6 TLM	33,31	Z STA LEL 6 TLM	24,09
8	L	M14X1.5	Z LEL 8 TLM	52,04	Z STA LEL 8 TLM	42,75
10	L	M16X1.5	Z LEL 10 TLM	45,48	Z STA LEL 10 TLM	35,51
12	L	M18X1.5	Z LEL 12 TLM	56,19	Z STA LEL 12 TLM	44,46
15	L	M22X1.5	Z LEL 15 TLM	77,75	Z STA LEL 15 TLM	62,09
18	L	M26X1.5	Z LEL 18 TLM	100,22	Z STA LEL 18 TLM	80,34
22	L	M30X2	Z LEL 22 TLM	144,60	Z STA LEL 22 TLM	118,37
28	L	M36X2	Z LEL 28 TLM	197,01	Z STA LEL 28 TLM	162,03
35	L	M45X2	Z LEL 35 TLM	352,62	Z STA LEL 35 TLM	296,71
42	L	M52X2	Z LEL 42 TLM	469,25	Z STA LEL 42 TLM	378,93
6	S	M14X1.5	Z LES 6 TLM	43,10	Z STA LES 6 TLM	33,14
8	S	M16X1.5	Z LES 8 TLM	54,90	Z STA LES 8 TLM	44,43
10	S	M18X1.5	Z LES 10 TLM	72,07	Z STA LES 10 TLM	59,69
12	S	M20X1.5	Z LES 12 TLM	64,43	Z STA LES 12 TLM	51,10
14	S	M22X1.5	Z LES 14 TLM	103,19	Z STA LES 14 TLM	85,35
16	S	M24X1.5	Z LES 16 TLM	109,93	Z STA LES 16 TLM	90,01
20	S	M30X2	Z LES 20 TLM	144,42	Z STA LES 20 TLM	116,70
25	S	M36X2	Z LES 25 TLM	241,58	Z STA LES 25 TLM	173,46
30	S	M42X2	Z LES 30 TLM	333,34	Z STA LES 30 TLM	252,24
38	S	M52X2	Z LES 38 TLM	488,66	Z STA LES 38 TLM	374,88

DIN 2353 Pipe fittings

Racores DIN 2353

Verschraubungen Din 2353

Raccords à bague DIN 2353

Straight connection with o'ring

Racor unión TL Métrica

Gerader Zwischenstutzen mit O-Ring

Raccord union tournante Métrique égale



TUBO PIPE	SERIE SERIES	Referencia Part n°	€
6	L	Z ATL 6	24,23
8	L	Z ATL 8	32,57
10	L	Z ATL 10	33,10
12	L	Z ATL 12	39,00
15	L	Z ATL 15	43,88
18	L	Z ATL 18	49,37
22	L	Z ATL 22	73,53
28	L	Z ATL 28	110,23
35	L	Z ATL 35	207,77
42	L	Z ATL 42	277,60
6	S	Z ATS 6	33,38
8	S	Z ATS 8	38,77
10	S	Z ATS 10	39,98
12	S	Z ATS 12	52,49
14	S	Z ATS 14	70,86
16	S	Z ATS 16	71,26
20	S	Z ATS 20	98,19
25	S	Z ATS 25	128,13
30	S	Z ATS 30	219,15
38	S	Z ATS 38	294,61

Straight stud standpipe adaptor with captive seal BSP cylindrical-metric swivel fem.

Racor recto macho BSP con junta plana - TLM

Gerader Einschraubstutzen BSP ZYL. M/Dichtkegel und O-Ring

Raccord adapt.tube lisse-mâle gaz BSP avec joint plat-fem.tourn.métrique



TUBO PIPE	SERIE SERIES	ROSCA THREAD	Referencia Part n°	€
6	L	1/8"BSP	Z RAL 6 R 1/8TLMWD	39,48
8	L	1/4"BSP	Z RAL 8 R 1/4TLMWD	16,72
10	L	1/4"BSP	Z RAL 10 R 1/4TLMWD	18,87
12	L	1/4"BSP	Z RAL 12 R 1/4TLMWD	19,81
12	L	3/8"BSP	Z RAL 12 R 3/8TLMWD	19,16
12	L	1/2"BSP	Z RAL 12 R 1/2TLMWD	26,06
15	L	1/2"BSP	Z RAL 15 R 1/2TLMWD	30,72
18	L	1/2"BSP	Z RAL 18 R 1/2TLMWD	31,53
22	L	3/4"BSP	Z RAL 22 R 3/4TLMWD	44,43
28	L	1"BSP	Z RAL 28 R 1TLMWD	61,96
35	L	1 1/4 BSP	Z RAL 35 R 1 1/4TLMWD	112,49
42	L	1 1/2 BSP	Z RAL 42 R 1 1/2TLMWD	109,17
6	S	1/4"BSP	Z RAS 6 R 1/4TLMWD	33,09
8	S	1/4"BSP	Z RAS 8 R 1/4TLMWD	17,30
10	S	3/8"BSP	Z RAS 10 R 3/8TLMWD	25,12
12	S	3/8"BSP	Z RAS 12 R 3/8TLMWD	24,84
12	S	1/2"BSP	Z RAS 12 R 1/2TLMWD	34,13
14	S	1/2"BSP	Z RAS 14 R 1/2TLMWD	29,57
16	S	1/2"BSP	Z RAS 16 R 1/2TLMWD	39,12
20	S	3/4"BSP	Z RAS 20 R 3/4TLMWD	49,96
25	S	1"BSP	Z RAS 25 R 1TLMWD	106,75
30	S	1 1/4 BSP	Z RAS 30 R 1 1/4TLMWD	142,21
38	S	1 1/2 BSP	Z RAS 38 R 1 1/2TLMWD	113,66

Straight stud standpipe adaptor NPT- metric swivel fem.

Racor recto macho NPT - TL Metrica

Gerader Einschraubstutzen NPT M/Dichtkegel

Raccord adapteur tube lisse - mâle NPT- fem. tourn. métrique



TUBO PIPE	SERIE SERIES	ROSCA THREAD	Referencia Part n°	€
6	L	1/8"NPT	Z RAL 6 R 1/8 NPTTLM	29,00
8	L	1/4"NPT	Z RAL 8 R 1/4 NPTTLM	38,83
10	L	1/4"NPT	Z RAL 10 R 1/4 NPTTLM	40,01
12	L	3/8" NPT	Z RAL 12 R 3/8 NPTTLM	55,98
15	L	1/2" NPT	Z RAL 15 R 1/2 NPTTLM	59,31
18	L	1/2"NPT	Z RAL 18 R 1/2 NPTTLM	84,40
22	L	3/4"NPT	Z RAL 22 R 3/4 NPTTLM	69,76
28	L	1"NPT	Z RAL 28 R 1 NPTTLM	93,93
35	L	1 1/4 NPT	Z RAL 35 R 1 1/4 NPTTLM	122,69
42	L	1 1/2 NPT	Z RAL 42 R 1 1/2 NPTTLM	186,84
6	S	1/4"NPT	Z RAS 6 R 1/4 NPTTLM	42,98
8	S	1/4"NPT	Z RAS 8 R 1/4 NPTTLM	28,81
10	S	3/8"NPT	Z RAS 10 R 3/8 NPTTLM	42,98
12	S	1/4" NPT	Z RAS 12 R 1/4 NPTTLM	34,71
14	S	1/2"NPT	Z RAS 14 R 1/2 NPTTLM	64,44
16	S	1/2"NPT	Z RAS 16 R 1/2 NPTTLM	84,56
20	S	3/4"NPT	Z RAS 20 R 3/4 NPTTLM	119,49
25	S	3/4"NPT	Z RAS 25 R 3/4 NPTTLM	110,83
25	S	1"NPT	Z RAS 25 R 1 NPTTLM	97,34
30	S	1"NPT	Z RAS 30 R 1 NPTTLM	120,96
30	S	1 1/4 NPT	Z RAS 30 R 1 1/4 NPTTLM	152,01
38	S	1 1/2 NPT	Z RAS 38 R 1 1/2 NPTTLM	307,58

Straight stud standpipe adaptor Metric with captive seal-metric swivel fem.

Racor recto macho Métrico con junta plana - tubo TLM

Gerader Einschraubstutzen metr. ZYL. M/ Dichtkegel und O-Ring

Raccord adapt.tube lisse-mâle Métrique avec joint plat-fem.tourn.métrique



TUBO PIPE	SERIE SERIES	ROSCA THREAD	Referencia Part n°	€
6	L	M10X1	Z RAL 6M10X1TLMWD	42,67
8	L	M12X1.5	Z RAL 8M12X1.5TLMWD	37,73
10	L	M14X1.5	Z RAL 10M14X1.5TLMWD	47,91
12	L	M16X1.5	Z RAL 12M16X1.5TLMWD	46,18
15	L	M18X1.5	Z RAL 15M18X1.5TLMWD	57,91
18	L	M22X1.5	Z RAL 18M22X1.5TLMWD	74,38
22	L	M26X1.5	Z RAL 22M26X1.5TLMWD	85,82
28	L	M33X2	Z RAL 28M33X2TLMWD	136,70
35	L	M42X2	Z RAL 35M42X2TLMWD	210,81
42	L	M48X2	Z RAL 42M48X2TLMWD	238,63
6	S	M12X1.5	Z RAS 6M12X1.5TLMWD	42,98
8	S	M14X1.5	Z RAS 8M14X1.5TLMWD	42,48
10	S	M16X1.5	Z RAS 10M16X1.5TLMWD	44,74
12	S	M18X1.5	Z RAS 12M18X1.5TLMWD	49,03
14	S	M20X1.5	Z RAS 14M20X1.5TLMWD	67,12
16	S	M22X1.5	Z RAS 16M22X1.5TLMWD	73,52
20	S	M27X2	Z RAS 20M27X2TLMWD	99,83
25	S	M33X2	Z RAS 25M33X2TLMWD	147,62
30	S	M42X2	Z RAS 30M42X2TLMWD	203,38
38	S	M48X2	Z RAS 38M48X2TLMWD	263,41

DIN 2353 Pipe fittings

Racores DIN 2353
Verschraubungen Din 2353
Raccords à bague DIN 2353

Weldable straight coupling

Racor recto para soldar

Gerade Anschweiß-Versch. (GAV)

Raccord mamelon hexagonal Métrique
à souder



TUBO PIPE	SERIE SERIES	Referencia Part n°	€	Referencia STA Part N° STA	€
6	L	Z ASL 6	13,02	Z STA ASL 6	8,34
8	L	Z ASL 8	13,07	Z STA ASL 8	8,36
10	L	Z ASL 10	15,72	Z STA ASL 10	10,67
12	L	Z ASL 12	17,19	Z STA ASL 12	11,26
15	L	Z ASL 15	23,42	Z STA ASL 15	15,52
18	L	Z ASL 18	27,86	Z STA ASL 18	17,86
22	L	Z ASL 22	36,75	Z STA ASL 22	23,58
28	L	Z ASL 28	51,63	Z STA ASL 28	34,08
35	L	Z ASL 35	81,68	Z STA ASL 35	53,67
42	L	Z ASL 42	119,11	Z STA ASL 42	73,88
6	S	Z ASS 6	22,21	Z STA ASS 6	17,17
8	S	Z ASS 8	25,31	Z STA ASS 8	20,01
10	S	Z ASS 10	29,63	Z STA ASS 10	23,38
12	S	Z ASS 12	30,60	Z STA ASS 12	23,87
14	S	Z ASS 14	45,21	Z STA ASS 14	36,23
16	S	Z ASS 16	33,94	Z STA ASS 16	23,92
20	S	Z ASS 20	41,60	Z STA ASS 20	27,68
25	S	Z ASS 25	68,90	Z STA ASS 25	34,77
30	S	Z ASS 30	94,87	Z STA ASS 30	54,26
38	S	Z ASS 38	195,57	Z STA ASS 38	138,62

Welding nipple with o-ring

Boquilla para soldar

Schweißkegel (SK)

Raccord collet cône métrique à souder



TUBO PIPE	SERIE SERIES	Referencia Part n°	€
15x2.5	L	Z ORIL 15	9,30
18x2.5	L	Z ORIL 18	10,45
22x2.5	L	Z ORIL 22	12,03
28x3	L	Z ORIL 28	19,22
35x4	L	Z ORIL 35	32,27
42x3	L	Z ORIL 42	39,58
6x2	L/S	Z ORIS 6	7,55
8x2	L/S	Z ORIS 8	8,63
10x2	L/S	Z ORIS 10	7,96
12x2	L/S	Z ORIS 12	8,08
14x3	S	Z ORIS 14	13,47
16x3	S	Z ORIS 16	12,27
20x3	S	Z ORIS 20	14,91
25x3.5	S	Z ORIS 25	22,04
30x5	S	Z ORIS 30	30,53
38x5	S	Z ORIS 38	41,93

Weldable bulkhead coupling

Racor pasatabique para soldar

Schweiß-Schottverschraubung (ESV)

Raccord union double passe cloison
Métrique à souder



TUBO PIPE	SERIE SERIES	Referencia Part n°	€	Referencia STA Part N° STA	€
6	L	Z ESVL 6	24,57	Z STA ESVL 6	15,35
8	L	Z ESVL 8	28,30	Z STA ESVL 8	19,00
10	L	Z ESVL 10	29,12	Z STA ESVL 10	19,15
12	L	Z ESVL 12	34,63	Z STA ESVL 12	22,89
15	L	Z ESVL 15	46,65	Z STA ESVL 15	30,98
18	L	Z ESVL 18	60,02	Z STA ESVL 18	40,14
22	L	Z ESVL 22	76,68	Z STA ESVL 22	50,44
28	L	Z ESVL 28	85,56	Z STA ESVL 28	50,58
35	L	Z ESVL 35	123,79	Z STA ESVL 35	67,89
42	L	Z ESVL 42	195,72	Z STA ESVL 42	105,40
6	S	Z ESVS 6	39,78	Z STA ESVS 6	29,82
8	S	Z ESVS 8	42,95	Z STA ESVS 8	32,48
10	S	Z ESVS 10	48,62	Z STA ESVS 10	36,23
12	S	Z ESVS 12	48,47	Z STA ESVS 12	35,14
14	S	Z ESVS 14	81,02	Z STA ESVS 14	63,18
16	S	Z ESVS 16	64,58	Z STA ESVS 16	44,67
20	S	Z ESVS 20	93,81	Z STA ESVS 20	66,09
25	S	Z ESVS 25	138,42	Z STA ESVS 25	70,30
30	S	Z ESVS 30	155,95	Z STA ESVS 30	74,86
38	S	Z ESVS 38	315,56	Z STA ESVS 38	201,78

DIN 2353 Pipe fittings

Racores DIN 2353

Verschraubungen Din 2353

Raccords à bague DIN 2353

Straight bulkhead coupling

Racor recto pasatabique con tuerca

Gerade Schottverschraubung - GSV

Raccord droit union double passe cloison avec écrou



TUBO PIPE	SERIE SERIES	Referencia Part n°	€	Referencia STA Part N° STA	€
6	L	Z SVL 6	22,40	Z STA SVL 6	13,18
8	L	Z SVL 8	25,66	Z STA SVL 8	16,36
10	L	Z SVL 10	33,47	Z STA SVL 10	23,50
12	L	Z SVL 12	37,37	Z STA SVL 12	25,64
15	L	Z SVL 15	50,47	Z STA SVL 15	34,80
18	L	Z SVL 18	68,59	Z STA SVL 18	48,71
22	L	Z SVL 22	91,50	Z STA SVL 22	65,27
28	L	Z SVL 28	109,23	Z STA SVL 28	74,25
35	L	Z SVL 35	180,60	Z STA SVL 35	124,69
42	L	Z SVL 42	243,23	Z STA SVL 42	152,90
6	S	Z SVS 6	34,09	Z STA SVS 6	24,14
8	S	Z SVS 8	35,54	Z STA SVS 8	25,06
10	S	Z SVS 10	42,86	Z STA SVS 10	30,48
12	S	Z SVS 12	51,79	Z STA SVS 12	38,46
14	S	Z SVS 14	64,95	Z STA SVS 14	47,11
16	S	Z SVS 16	65,00	Z STA SVS 16	45,08
20	S	Z SVS 20	107,87	Z STA SVS 20	80,15
25	S	Z SVS 25	175,92	Z STA SVS 25	107,80
30	S	Z SVS 30	199,57	Z STA SVS 30	118,48
38	S	Z SVS 38	340,09	Z STA SVS 38	226,31

Elbow bulkhead coupling

Racor en codo pasatabique con tuerca

W-Schottverschchr. - WSV

Raccord coude égal passe cloison



TUBO PIPE	SERIE SERIES	Referencia Part n°	€	Referencia STA Part N° STA	€
6	L	Z USVL 6	48,84	Z STA USVL 6	39,62
8	L	Z USVL 8	46,64	Z STA USVL 8	37,35
10	L	Z USVL 10	44,07	Z STA USVL 10	34,11
12	L	Z USVL 12	47,76	Z STA USVL 12	36,03
15	L	Z USVL 15	80,42	Z STA USVL 15	64,75
18	L	Z USVL 18	84,69	Z STA USVL 18	64,81
22	L	Z USVL 22	129,77	Z STA USVL 22	103,54
28	L	Z USVL 28	354,96	Z STA USVL 28	319,99
35	L	Z USVL 35	617,40	Z STA USVL 35	561,50
42	L	Z USVL 42	827,29	Z STA USVL 42	736,97
6	S	Z USVS 6	81,28	Z STA USVS 6	71,33
8	S	Z USVS 8	63,62	Z STA USVS 8	53,15
10	S	Z USVS 10	57,19	Z STA USVS 10	44,81
12	S	Z USVS 12	63,48	Z STA USVS 12	50,15
14	S	Z USVS 14	97,93	Z STA USVS 14	80,09
16	S	Z USVS 16	89,50	Z STA USVS 16	69,58
20	S	Z USVS 20	212,85	Z STA USVS 20	185,13
25	S	Z USVS 25	401,96	Z STA USVS 25	333,84
30	S	Z USVS 30	625,06	Z STA USVS 30	543,96

Metric nut bulkhead

Tuerca pasatabique Métrica

Metr. Gegenmuttern für Schottverschraubungen - GM-M

Écrou Métrique passe cloison



TUBO PIPE	ROSCA THREAD	Referencia Part n°	€
6L	M12x1.5	KZTPM12	2,80
8L / 6S	M14x1.5	KZTPM14	1,45
10L / 8S	M16x1.5	KZTPM16	4,18
12L / 10S	M18x1.5	KZTPM18	4,29
12S	M20x1.5	KZTPM20	5,16
15L / 14S	M22x1.5	KZTPM22	5,63
16S	M24x1.5	KZTPM24	7,40
18L	M26x1.5	KZTPM26	9,87
22L / 20S	M30x2	KZTPM30	13,32
28L / 25S	M36x2	KZTPM36	16,48
30S	M42x2	KZTPM42	19,74
35L	M45x2	KZTPM45	23,69
42L / 38S	M52x2	KZTPM52	34,54

DIN 2353 Pipe fittings

Racores DIN 2353
Verschraubungen Din 2353
Raccords à bague DIN 2353

Female stud coupling

Racor recto hembra rosca BSP

Gerader Aufschraubstutzen – Innengewinde
BSP = GAI- R

Raccord union simple femelle gaz



TUBO PIPE	SERIE SERIES	ROSCA THREAD	Referencia Part n°	€	Referencia STA Part N° STA	€
6	L	1/8" BSP	Z GAIL 6 R 1/8	15,27	Z STA GAIL 6 R 1/8	10,60
6	L	1/4" BSP	Z GAIL 6 R 1/4	16,45	Z STA GAIL 6 R 1/4	11,77
8	L	1/4" BSP	Z GAIL 8 R 1/4	17,93	Z STA GAIL 8 R 1/4	13,22
10	L	1/4" BSP	Z GAIL 10 R 1/4	18,40	Z STA GAIL 10 R 1/4	13,35
12	L	1/2" BSP	Z GAIL 12 R 1/2	26,48	Z STA GAIL 12 R 1/2	20,55
12	L	3/8" BSP	Z GAIL 12 R 3/8	25,73	Z STA GAIL 12 R 3/8	19,80
15	L	1/2" BSP	Z GAIL 15 R 1/2	28,82	Z STA GAIL 15 R 1/2	20,92
18	L	1/2" BSP	Z GAIL 18 R 1/2	32,71	Z STA GAIL 18 R 1/2	22,70
22	L	3/4" BSP	Z GAIL 22 R 3/4	43,66	Z STA GAIL 22 R 3/4	30,48
28	L	1" BSP	Z GAIL 28 R 1	70,46	Z STA GAIL 28 R 1	52,91
35	L	1 1/4" BSP	Z GAIL 35 R 1 1/4	132,82	Z STA GAIL 35 R 1 1/4	104,81
42	L	1 1/2" BSP	Z GAIL 42 R 1 1/2	176,35	Z STA GAIL 42 R 1 1/2	131,13
6	S	1/4" BSP	Z GAIS 6 R 1/4	19,66	Z STA GAIS 6 R 1/4	14,62
8	S	1/4" BSP	Z GAIS 8 R 1/4	20,59	Z STA GAIS 8 R 1/4	15,29
10	S	3/8" BSP	Z GAIS 10 R 3/8	23,90	Z STA GAIS 10 R 3/8	17,64
12	S	3/8" BSP	Z GAIS 12 R 3/8	29,94	Z STA GAIS 12 R 3/8	23,21
14	S	3/8" BSP	Z GAIS 14 R 3/8	39,93	Z STA GAIS 14 R 3/8	30,94
14	S	1/2" BSP	Z GAIS 14 R 1/2	37,84	Z STA GAIS 14 R 1/2	28,85
16	S	1/2" BSP	Z GAIS 16 R 1/2	31,41	Z STA GAIS 16 R 1/2	21,39
20	S	3/4" BSP	Z GAIS 20 R 3/4	60,04	Z STA GAIS 20 R 3/4	46,12
25	S	1" BSP	Z GAIS 25 R 1	73,79	Z STA GAIS 25 R 1	39,67
30	S	1 1/4" BSP	Z GAIS 30 R 1 1/4	133,23	Z STA GAIS 30 R 1 1/4	92,62
38	S	1 1/2" BSP	Z GAIS 38 R 1 1/2	170,93	Z STA GAIS 38 R 1 1/2	113,97

Gauge coupling BSP cylindrical

Racor para manómetro BSP

Manometer-Verschraubung BSP ZYL - MAV-BSP

Raccord union pour manomètre gaz



TUBO PIPE	SERIE SERIES	ROSCA THREAD	Referencia Part n°	€
6	L	1/4" BSP	Z MAVL 6 R 1/4	21,62
8	L	1/4" BSP	Z MAVL 8 R 1/4	17,23
10	L	1/4" BSP	Z MAVL 10 R 1/4	21,18
12	L	1/4" BSP	Z MAVL 12 R 1/4	16,83
6	S	1/2" BSP	Z MAVS 6 R 1/2	29,27
8	S	1/2" BSP	Z MAVS 8 R 1/2	28,93
10	S	1/2" BSP	Z MAVS 10 R 1/2	56,02
12	S	1/2" BSP	Z MAVS 12 R 1/2	31,75

Seal for gauge coupling

Arandela para manómetros

Dichtkanten-Ring für Manometer-Anschlüsse - DKI

Raccord bague pour manomètres



ROSCA THREAD	Referencia Part n°	€
1/4" BSP	Z AM 6	7,73
1/2" BSP	Z AM 12	8,95

Female stud coupling Metric Cylindrical

Racor recto hembra rosca Métrica

Gerader Aufschraubstutzen – metr. Innengewinde
= GAI- M

Raccord union simple femelle Métrique



TUBO PIPE	SERIE SERIES	ROSCA THREAD	Referencia Part n°	€
6	L	M10X1	Z GAIL 6 M 10X1	24,75
8	L	M12X1.5	Z GAIL 8 M 12X1.5	30,72
10	L	M14X1.5	Z GAIL 10 M 14X1.5	34,06
12	L	M16X1.5	Z GAIL 12 M 16X1.5	31,28
15	L	M18X1.5	Z GAIL 15 M 18X1.5	57,56
18	L	M22X1.5	Z GAIL 18 M 22X1.5	68,41
22	L	M26X1.5	Z GAIL 22 M 26X1.5	57,96
28	L	M33X2	Z GAIL 28 M 33X2	114,05
35	L	M42X2	Z GAIL 35 M 42X2	207,05
42	L	M48X2	Z GAIL 42 M 48X2	275,15
6	S	M12X1.5	Z GAIS 6 M 12X1.5	35,09
8	S	M14X1.5	Z GAIS 8 M 14X1.5	42,48
10	S	M16X1.5	Z GAIS 10 M 16X1.5	40,88
12	S	M18X1.5	Z GAIS 12 M 18X1.5	50,89
14	S	M20X1.5	Z GAIS 14 M 20X1.5	63,18
16	S	M22X1.5	Z GAIS 16 M 22X1.5	68,41
20	S	M27X2	Z GAIS 20 M 27X2	97,20
25	S	M33X2	Z GAIS 25 M 33X2	139,49
30	S	M42X2	Z GAIS 30 M 42X2	260,11
38	S	M48X2	Z GAIS 38 M 48X2	353,16

Gauge coupling DKOL/DKOS cylindrical

Racor para manómetro DKOL/DKOS

Manometer-Verschraubung DKOL/DKOS

Raccord union pour manomètre DKOL/DKOS



TUBO PIPE	SERIE SERIES	ROSCA THREAD	Referencia Part n°	€
6	L	1/4" BSP	Z MAFL 6 R 1/4	19,39
8	L	1/4" BSP	Z MAFL 8 R 1/4	19,77
10	L	1/4" BSP	Z MAFL 10 R 1/4	20,53
12	L	1/4" BSP	Z MAFL 12 R 1/4	21,36
6	S	1/2" BSP	Z MAFS 6 R 1/2	28,44
8	S	1/2" BSP	Z MAFS 8 R 1/2	28,52
10	S	1/2" BSP	Z MAFS 10 R 1/2	29,28
12	S	1/2" BSP	Z MAFS 12 R 1/2	30,04

NEW

DIN 2353 Pipe fittings

Racores DIN 2353

Verschraubungen Din 2353

Raccords à bague DIN 2353

Banjo coupling with captive seal and o'ring BSP cylindrical

Racor en codo orientable sin estrangulación rosca BSP

Schwenkversch. mit Dichtkegel und O-Ring BSP ZYL

Raccord équerre orientable articulée sans étranglement gaz



TUBO PIPE	SERIE SERIES	ROSCA THREAD	Referencia Part n°	€	Referencia STA Part N° STA	€
6	L	1/8" BSP	Z WSVL 6 R 1/8	73,77	Z STA WSVL 6 R 1/8	69,10
6	L	1/4" BSP	Z WSVL 6 R 1/4	87,92	Z STA WSVL 6 R 1/4	83,25
8	L	1/4" BSP	Z WSVL 8 R 1/4	78,57	Z STA WSVL 8 R 1/4	73,86
10	L	1/4" BSP	Z WSVL 10 R 1/4	81,96	Z STA WSVL 10 R 1/4	76,91
12	L	3/8" BSP	Z WSVL 12 R 3/8	91,15	Z STA WSVL 12 R 3/8	85,22
15	L	1/2" BSP	Z WSVL 15 R 1/2	151,62	Z STA WSVL 15 R 1/2	143,72
18	L	1/2" BSP	Z WSVL 18 R 1/2	197,99	Z STA WSVL 18 R 1/2	187,99
22	L	3/4" BSP	Z WSVL 22 R 3/4	317,04	Z STA WSVL 22 R 3/4	303,86
28	L	1" BSP	Z WSVL 28 R 1	522,39	Z STA WSVL 28 R 1	504,84
35	L	1 1/4" BSP	Z WSVL 35 R 1 1/4	678,20	Z STA WSVL 35 R 1 1/4	650,18
42	L	1 1/2" BSP	Z WSVL 42 R 1 1/2	950,92	Z STA WSVL 42 R 1 1/2	905,70
6	S	1/4" BSP	Z WSVS 6 R 1/4	85,67	Z STA WSVS 6 R 1/4	80,63
8	S	1/4" BSP	Z WSVS 8 R 1/4	85,93	Z STA WSVS 8 R 1/4	80,63
10	S	3/8" BSP	Z WSVS 10 R 3/8	112,22	Z STA WSVS 10 R 3/8	105,97
12	S	3/8" BSP	Z WSVS 12 R 3/8	124,91	Z STA WSVS 12 R 3/8	118,18
14	S	1/2" BSP	Z WSVS 14 R 1/2	170,35	Z STA WSVS 14 R 1/2	161,36
16	S	1/2" BSP	Z WSVS 16 R 1/2	207,02	Z STA WSVS 16 R 1/2	197,00
20	S	3/4" BSP	Z WSVS 20 R 3/4	320,41	Z STA WSVS 20 R 3/4	306,49
25	S	1" BSP	Z WSVS 25 R 1	464,58	Z STA WSVS 25 R 1	430,46
30	S	1 1/4" BSP	Z WSVS 30 R 1 1/4	1.067,10	Z STA WSVS 30 R 1 1/4	1.026,49
38	S	1 1/2" BSP	Z WSVS 38 R 1 1/2	1.151,38	Z STA WSVS 38 R 1 1/2	1.094,43

Banjo coupling with captive seal and o'ring Metric cylindrical

Racor en codo orientable sin estrangulación rosca Métrica

Schwenkversch. mit Dichtkegel und O-Ring metr. ZYL

Raccord équerre orientable articulée sans étranglement Métrique



TUBO PIPE	SERIE SERIES	ROSCA THREAD	Referencia Part n°	€	Referencia STA Part N° STA	€
6	L	M10X1	Z WSVL 6 M 10X1	74,85	Z STA WSVL 6 M 10X1	70,17
8	L	M12X1.5	Z WSVL 8 M 12X1,5	78,23	Z STA WSVL 8 M 12X1,5	73,52
10	L	M14X1.5	Z WSVL 10 M 14X1,5	109,87	Z STA WSVL 10 M 14X1,5	104,82
12	L	M16X1.5	Z WSVL 12 M 16X1,5	125,02	Z STA WSVL 12 M 16X1,5	119,09
15	L	M18X1.5	Z WSVL 15 M 18X1,5	167,79	Z STA WSVL 15 M 18X1,5	159,89
18	L	M22X1.5	Z WSVL 18 M 22X1,5	213,32	Z STA WSVL 18 M 22X1,5	203,31
22	L	M26X1.5	Z WSVL 22 M 26X1,5	*	Z STA WSVL 22 M 26X1,5	*
28	L	M33X2	Z WSVL 28 M 33X2	*	Z STA WSVL 28 M 33X2	*
35	L	M42X2	Z WSVL 35 M 42X2	*	Z STA WSVL 35 M 42X2	*
42	L	M48X2	Z WSVL 42 M 48X2	*	Z STA WSVL 42 M 48X2	*
6	S	M12X1.5	Z WSVS 6 M 12X1,5	104,67	Z STA WSVS 6 M 12X1,5	99,62
8	S	M14X1.5	Z WSVS 8 M 14X1,5	111,65	Z STA WSVS 8 M 14X1,5	106,35
10	S	M16X1.5	Z WSVS 10 M 16X1,5	130,30	Z STA WSVS 10 M 16X1,5	124,05
12	S	M18X1.5	Z WSVS 12 M 18X1,5	147,25	Z STA WSVS 12 M 18X1,5	140,52
14	S	M20X1.5	Z WSVS 14 M 20X1,5	141,73	Z STA WSVS 14 M 20X1,5	132,75
16	S	M22X1.5	Z WSVS 16 M 22X1,5	255,46	Z STA WSVS 16 M 22X1,5	245,43
20	S	M27X2	Z WSVS 20 M 27X2	329,96	Z STA WSVS 20 M 27X2	316,04
30	S	M42X2	Z WSVS 30 M 42X2	669,80	Z STA WSVS 30 M 42X2	629,19
38	S	M48x2	Z WSVS 38 M 48X2	*	Z STA WSVS 38 M 48X2	*

DIN 2353 Pipe fittings

Racores DIN 2353
Verschraubungen Din 2353
Raccords à bague DIN 2353

Blanking plug with o'ring

Tapón de cierre para tubo con junta tórica

Verschlusskegel mit O-Ring

Raccord bouchon de fermeture avec o'ring



Green FKM o-ring

Juntas tóricas FKM verde

O-Ring FKM grün - DOZ FKM

Joint torique en FKM vert



TUBO PIPE	SERIE SERIES	Referencia Part n°	€
6	L/S	Z BUTZEN L 6	5,73
8	L/S	Z BUTZEN L 8	5,73
10	L/S	Z BUTZEN L 10	6,02
12	L/S	Z BUTZEN L 12	6,95
15	L	Z BUTZEN L 15	8,73
18	L	Z BUTZEN L 18	9,55
22	L	Z BUTZEN L 22	10,02
28	L	Z BUTZEN L 28	14,68
35	L	Z BUTZEN L 35	27,42
42	L	Z BUTZEN L 42	39,26
14	S	Z BUTZEN S 14	9,35
16	S	Z BUTZEN S 16	10,05
20	S	Z BUTZEN S 20	16,36
25	S	Z BUTZEN S 25	15,70
30	S	Z BUTZEN S 30	19,73
38	S	Z BUTZEN S 38	42,11

TUBO PIPE	Referencia Part n°	€
6	JVT06	0,83
8	JVT08	0,90
10	JVT10	0,97
12	JVT12	1,02
14	JVT14	1,11
15-16	JVT15	1,09
18	JVT18	1,29
20	JVT20	1,29
22	JVT22	1,38
25	JVT25	1,43
28	JVT28	1,50
30	JVT30	1,60
35	JVT35	2,22
38	JVT38	2,34
42	JVT42	2,54

Blanking plug with captive seal BSP cylindrical

Tapón de cierre Allen rosca BSP con junta

Verschlussverschraubung Innensechskant mit
Dichtung BSP

Raccord bouchon Allen gaz avec joint plat



ROSCA THREAD	Referencia Part n°	€
1/8" BSP	Z STOPFEN 1/8	5,04
1/4" BSP	Z STOPFEN 1/4	5,30
3/8" BSP	Z STOPFEN 3/8	6,59
1/2" BSP	Z STOPFEN 1/2	8,14
3/4" BSP	Z STOPFEN 3/4	11,93
1" BSP	Z STOPFEN 1	18,92
1"1/4 BSP	Z STOPFEN 1 1/4	29,46
1"1/2 BSP	Z STOPFEN 1 1/2	41,49

Green FKM captive seal

Juntas planas FKM verde

Dichtring flach FKM grün- DOZ FKM KL

Joint plat en FKM vert



ROSCA THREAD	Referencia Part n°	€
1/8" BSP - M10x1	JVBSP02	3,19
M12x1.5	JVM12	3,19
1/4" BSP - M14x1.5	JVBSP04	3,13
M16x1.5	JVM16	3,19
3/8" BSP	JVBSP06	3,19
M18x1.5	JVM18	3,33
M20x1.5	JVM20	3,33
1/2" BSP	JVBSP08	3,34
M22x1.5	JVM22	3,41
3/4" BSP - M26x1.5	JVBSP12	3,40
1" BSP - M33x2	JVBSP16	3,54
1"1/4 BSP - M42x2	JVBSP20	5,42
1"1/2 BSP - M48x2	JVBSP24	5,83
2" BSP	JVBSP32	20,15

Blanking plug with captive seal Metric cylindrical

Tapón de cierre Allen rosca Métrica con junta

Verschlussverschraubung Innensechskant mit
Dichtung Metr.

Raccord bouchon Allen Métrique avec joint plat



ROSCA THREAD	Referencia Part n°	€
M10X1	Z STOPFEN M 10X1	4,84
M12X1.5	Z STOPFEN M 12X1,5	5,46
M14X1.5	Z STOPFEN M 14X1,5	6,04
M16X1.5	Z STOPFEN M 16X1,5	6,39
M18X1.5	Z STOPFEN M 18X1,5	6,78
M20X1.5	Z STOPFEN M 20X1,5	8,04
M22X1.5	Z STOPFEN M 22X1,5	8,54
M26X1.5	Z STOPFEN M 26X1,5	20,13
M27X2	Z STOPFEN M 27X2	20,13
M33X2	Z STOPFEN M 33X2	23,24
M42X2	Z STOPFEN M 42X2	24,79
M48X2	Z STOPFEN M 48X2	48,41

DIN 2353 Pipe fittings

Racores DIN 2353
Verschraubungen Din 2353
Raccords à bague DIN 2353

Tool for manual pre-assembly

Vomo

Werkzeug für die manuelle Vormontage

Outil pour pre-montage



TUBO PIPE	SERIE SERIES	ROSCA THREAD	Referencia Part n°	€
6	L	12x1.5	Z VOMO L 6	*
8	L	14x1.5	Z VOMO L 8	*
10	L	16x1.5	Z VOMO L 10	*
12	L	18x1.5	Z VOMO L 12	*
15	L	22x1.5	Z VOMO L 15	*
18	L	26x1.5	Z VOMO L 18	*
22	L	30x2.0	Z VOMO L 22	*
28	L	36x2.0	Z VOMO L 28	*
35	L	45x2.0	Z VOMO L 35	*
42	L	52x2.0	Z VOMO L 42	*
6	S	14x1.5	Z VOMO S 6	*
8	S	16x1.5	Z VOMO S 8	*
10	S	18x1.5	Z VOMO S 10	*
12	S	20x1.5	Z VOMO S 12	*
14	S	22x1.5	Z VOMO S 14	*
16	S	24x1.5	Z VOMO S 16	*
20	S	30x2.0	Z VOMO S 20	*
25	S	36x2.0	Z VOMO S 25	*
30	S	42x2.0	Z VOMO S 30	*

Made of Hardened tool-steel / Material Acero Templado / Material Gehärteter Stahl / Matériel Acier Trempé

Grease

Grasa

Fett

Graisse



PESO (gr) WEIGHT (gr)	Referencia Part n°	€
145	GR ASW120	71,70

DIN 2353 Pipe fittings

Racores DIN 2353
Verschraubungen Din 2353
Raccords à bague DIN 2353

Non-return valve flow from male stud end BSP cylindrical

Válvula antirretorno rosca BSP-tubo

Rückschlagventil einseitig sperrend BSP Stecker (m)-Rohr

Clapet anti-rétour unidirectionnel à gauche mâle-tube



TUBO PIPE	SERIE SERIES	ROSCA THREAD	Referencia Part n°	€
6	L	1/8" BSP	Z RHVL 6 R 1/8	*
8	L	1/4" BSP	Z RHVL 8 R 1/4	*
10	L	1/4" BSP	Z RHVL 10 R 1/4	*
12	L	3/8" BSP	Z RHVL 12 R 3/8	*
15	L	1/2" BSP	Z RHVL 15 R 1/2	*
18	L	1/2" BSP	Z RHVL 18 R 1/2	*
22	L	3/4" BSP	Z RHVL 22 R 3/4	*
28	L	1" BSP	Z RHVL 28 R 1	*
35	L	1"1/4 BSP	Z RHVL 35 R 1 1/4	*
42	L	1"1/2 BSP	Z RHVL 42 R 1 1/2	*
6	S	1/4" BSP	Z RHVS 6 R 1/4	*
8	S	1/4" BSP	Z RHVS 8 R 1/4	*
10	S	3/8" BSP	Z RHVS 10 R 3/8	*
12	S	3/8" BSP	Z RHVS 12 R 3/8	*
14	S	1/2" BSP	Z RHVS 14 R 1/2	*
16	S	1/2" BSP	Z RHVS 16 R 1/2	*
20	S	3/4" BSP	Z RHVS 20 R 3/4	*
25	S	1" BSP	Z RHVS 25 R 1	*
30	S	1"1/4 BSP	Z RHVS 30 R 1 1/4	*
38	S	1"1/2 BSP	Z RHVS 38 R 1 1/2	*

Setting 1 bar. For other standard spring pressures, consult us. / Taraje 1 bar. Para otras presiones de tarado estandard, consultar. / Einstellung-Druck 1 bar. Bitte kontaktieren Sie uns für andere Standard-Drucke. / Tarage 1 bar. Pour d'autres pressions ressort standard, consultez-nous.

Non-return valve tube-tube

Válvula antirretorno tubo-tubo

Rückschlagventil beidseitiger Rohranschluß

Clapet anti-rétour bidirectionnel tube-tube



TUBO PIPE	SERIE SERIES	Referencia Part n°	€	Referencia STA Part N° STA	€
6	L	Z RHDL 6	40,22	Z STA RHDL 6	31,00
8	L	Z RHDL 8	49,73	Z STA RHDL 8	40,43
10	L	Z RHDL 10	48,16	Z STA RHDL 10	38,19
12	L	Z RHDL 12	58,01	Z STA RHDL 12	46,27
15	L	Z RHDL 15	68,36	Z STA RHDL 15	52,69
18	L	Z RHDL 18	94,43	Z STA RHDL 18	74,55
22	L	Z RHDL 22	127,45	Z STA RHDL 22	101,22
28	L	Z RHDL 28	212,20	Z STA RHDL 28	177,23
35	L	Z RHDL 35	760,41	Z STA RHDL 35	704,51
42	L	Z RHDL 42	1.176,73	Z STA RHDL 42	1.086,41
6	S	Z RHDS 6	40,55	Z STA RHDS 6	30,59
8	S	Z RHDS 8	42,09	Z STA RHDS 8	31,61
10	S	Z RHDS 10	50,15	Z STA RHDS 10	37,77
12	S	Z RHDS 12	59,02	Z STA RHDS 12	45,69
14	S	Z RHDS 14	72,26	Z STA RHDS 14	54,42
16	S	Z RHDS 16	85,62	Z STA RHDS 16	65,70
20	S	Z RHDS 20	112,03	Z STA RHDS 20	84,30
25	S	Z RHDS 25	194,34	Z STA RHDS 25	126,22
30	S	Z RHDS 30	326,02	Z STA RHDS 30	244,93
38	S	Z RHDS 38	715,02	Z STA RHDS 38	601,24

Setting 1 bar. For other standard spring pressures, consult us. / Taraje 1 bar. Para otras presiones de tarado estandard, consultar. / Einstellung-Druck 1 bar. Bitte kontaktieren Sie uns für andere Standard-Drucke. / Tarage 1 bar. Pour d'autres pressions ressort standard, consultez-nous.

Non-return valve flow towards male stud end BSP cylindrical

Válvula antirretorno tubo-rosca BSP

Rückschlagventil einseitig sperrend BSP Rohr Stecker (m)

Clapet anti-rétour unidirectionnel à droite tube-mâle



TUBO PIPE	SERIE SERIES	ROSCA THREAD	Referencia Part n°	€
6	L	1/8" BSP	Z RHZL 6 R 1/8	*
8	L	1/4" BSP	Z RHZL 8 R 1/4	*
10	L	1/4" BSP	Z RHZL 10 R 1/4	*
12	L	3/8" BSP	Z RHZL 12 R 3/8	*
15	L	1/2" BSP	Z RHZL 15 R 1/2	*
18	L	1/2" BSP	Z RHZL 18 R 1/2	*
22	L	3/4" BSP	Z RHZL 22 R 3/4	*
28	L	1" BSP	Z RHZL 28 R 1	*
35	L	1"1/4 BSP	Z RHZL 35 R 1 1/4	*
42	L	1"1/2 BSP	Z RHZL 42 R 1 1/2	*
6	S	1/4" BSP	Z RHZS 6 R 1/4	*
8	S	1/4" BSP	Z RHZS 8 R 1/4	*
10	S	3/8" BSP	Z RHZS 10 R 3/8	*
12	S	3/8" BSP	Z RHZS 12 R 3/8	*
14	S	1/2" BSP	Z RHZS 14 R 1/2	*
16	S	1/2" BSP	Z RHZS 16 R 1/2	*
20	S	3/4" BSP	Z RHZS 20 R 3/4	*
25	S	1" BSP	Z RHZS 25 R 1	*
30	S	1"1/4 BSP	Z RHZS 30 R 1 1/4	*
38	S	1"1/2 BSP	Z RHZS 38 R 1 1/2	*

Setting 1 bar. For other standard spring pressures, consult us. / Taraje 1 bar. Para otras presiones de tarado estandard, consultar. / Einstellung-Druck 1 bar. Bitte kontaktieren Sie uns für andere Standard-Drucke. / Tarage 1 bar. Pour d'autres pressions ressort standard, consultez-nous.

Incorporamos válvulas antirretorno sin tuerca ni anillo

Non-return valve only body

Flare fittings JIC 37°

Racores JIC 37°
JIC - Verbindungen
Adapteurs JIC 37°

Nut JIC 37°

Tuercas JIC 37°

Muttern JIC 37° - M JIC

Écrou JIC 37°



TUBO PIPE	ROSCA THREAD	Referencia Part n°	€
6	1/4"	7/16" 20h UNF	ZS11006 6,35
8	5/16"	1/2" 20h UNF	ZS11008 4,58
10	3/8"	9/16" 18h UNF	ZS11010 4,80
12	1/2"	3/4" 16h UNF	ZS11012 4,81
14-15-16	5/8"	7/8" 14h UNF	ZS11016 6,98
18-20	-	1"1/16 12h UN	ZS11020 10,77
-	3/4"	1"1/16 12h UNF	ZS11020W 17,92
25	1"	1"5/16 12h UN	ZS11025 25,58
30-32	1 1/4"	1"5/8 12h UN	ZS11032 39,56
38	1 1/2"	1"7/8 12h UN	ZS11038 72,88

Metric tube sleeves JIC 37°

Ferulas JIC 37° (tubo Métrico)

Druckring (Stützring) metr.

Ferrules JIC 37° pour tube Métrique



TUBO PIPE	Referencia Part n°	€
6	ZS12006	2,39
8	ZS12008	2,87
10	ZS12010	3,02
12	ZS12012	3,45
14	ZS12014	7,30
15	ZS12015	7,30
16	ZS12016	7,03
18	ZS12018	8,25
20	ZS12020	8,50
25	ZS12025	15,68
30	ZS12030	15,72
32	ZS12032	17,12
38	ZS12038	26,75

Tube sleeves Gas JIC 37°

Ferulas JIC 37° (tubo Gas)

Druckring (Stützring) GAS

Ferrules JIC 37° pour tube Gaz



TUBO PIPE	Referencia Part n°	€
1/4"	ZS12104	3,66
5/16"	ZS12105	4,02
3/8"	ZS12106	4,76
1/2"	ZS12108	5,52
5/8"	ZS12110	5,63
3/4"	ZS12112	8,04
1"	ZS12116	18,83
1"1/4	ZS12120	25,50
1"1/2	ZS12124	34,16

Plug male JIC 37°

Tapón macho JIC 37°

Verschlussstopfen JIC 37°

Bouchon mâle JIC 37°



TUBO PIPE	ROSCA THREAD	Referencia Part n°	€
6	1/4"	7/16" 20h UNF	ZS14006 7,85
8	5/16"	1/2" 20h UNF	ZS14008 7,93
10	3/8"	9/16" 18h UNF	ZS14010 11,31
12	1/2"	3/4" 16h UNF	ZS14012 12,62
14-15-16	5/8"	7/8" 14h UNF	ZS14016 15,08
18-20	3/4"	1"1/16 12h UN	ZS14020 20,84
25	1"	1"5/16 12h UN	ZS14025 27,61
30-32	1 1/4"	1"5/8 12h UN	ZS14032 43,65
38	1 1/2"	1"7/8 12h UN	ZS14038 71,90

Cap JIC 37°

Tapón hembra giratoria JIC 37°

Verschlussmutter JIC 37°

Bouchon femelle JIC 37°



TUBO PIPE	ROSCA THREAD	Referencia Part n°	€
6	1/4"	7/16"-20h UNF	ZS13006 13,92
8	5/16"	1/2"-20h UNF	ZS13008 14,36
10	3/8"	9/16"-18h UNF	ZS13010 14,87
12	1/2"	3/4"-16h UNF	ZS13012 16,75
14-15-16	5/8"	7/8"-14h UNF	ZS13016 15,86
18-20	3/4"	1"1/16-12h UN	ZS13020 22,78
25	1"	1"5/16-12h UN	ZS13025 40,42
30-32	1 1/4"	1"5/8-12h UN	ZS13032 56,59
38	1 1/2"	1"7/8-12h UN	ZS13038 95,25

Flare fittings JIC 37°

Racores JIC 37°
JIC - Verbindungen
Adapteurs JIC 37°

Straight union JIC 37°

Racor macho-macho JIC 37°

Gerade Verschraubung AGJ-AGJ

Adapteur droit mâle JIC 37°



TUBO PIPE	ROSCA THREAD	Referencia Part n°	€
6 1/4"	7/16" 20h UNF	ZS26006	11,92
8 5/16"	1/2" 20h UNF	ZS26008	13,51
10 3/8"	9/16" 18h UNF	ZS26010	13,69
12 1/2"	3/4" 16h UNF	ZS26012	15,54
14-15-16 5/8"	7/8" 14h UNF	ZS26016	20,63
18-20 3/4"	1"1/16 12h UN	ZS26020	24,69
25 1"	1"5/16 12h UN	ZS26025	37,72
30-32 1" 1/4"	1"5/8 12h UN	ZS26032	55,81
38 1" 1/2"	1"7/8 12h UN	ZS26038	75,42
50 2"	2" 1/2 12h UN	ZS26050	135,02

Reducer adaptor male JIC 37°

Racor reducción macho-macho JIC 37°

Reduzieranschlüsse m - m JIC 37°

Adapteur réduction mâle JIC 37°



TUBO PIPE	ROSCA THREAD	Referencia Part n°	€
8 5/16" 6 1/4"	1/2" 20h UNF 7/16" 20h UNF	ZS2600806	14,08
10 5/16" 6 1/4"	9/16" 18h UNF 7/16" 20h UNF	ZS2601006	17,63
10 3/8" 8 5/16"	9/16" 18h UNF 1/2" 20h UNF	ZS2601008	16,44
12 1/2" 6 1/4"	3/4" 16h UNF 7/16" 20h UNF	NEW ZS2601206	25,12
12 1/2" 10 3/8"	3/4" 16h UNF 9/16" 18h UNF	ZS2601210	22,16
14-15-16 5/8" 12 1/2"	7/8" 14h UNF 3/4" 16h UNF	ZS2601612	23,07
18-20 3/4" 14-15-16 5/8"	1"1/16 12h UN 7/8" 14h UNF	ZS2602016	29,97
25 1" 18-20 3/4"	1"5/16 12h UN 1"1/16 12h UN	ZS2602520	38,33
30-32 1"1/4 25 1"	1"5/8 12h UN 1"5/16 12h UN	ZS2603225	55,96
38 1"1/2 30-32 1"1/4	1"7/8 12h UN 1"5/8 12h UN	ZS2603832	86,26

Straight bulkhead fitting JIC 37°

Racor pasatabiques JIC 37°

Schottverschraubung - SV JIC 37°

Union passe cloison droite mâle JIC 37° équipé



TUBO PIPE	ROSCA THREAD	Referencia Part n°	€
6 1/4"	7/16" 20h UNF	ZS25006	21,89
8 5/16"	1/2" 20h UNF	ZS25008	22,17
10 3/8"	9/16" 18h UNF	ZS25010	26,77
12 1/2"	3/4" 16h UNF	ZS25012	27,47
14-15-16 5/8"	7/8" 14h UNF	ZS25016	37,75
18-20 3/4"	1"1/16 12h UN	ZS25020	52,89
25 1"	1"5/16 12h UN	ZS25025	70,36
30-32 1" 1/4"	1"5/8 12h UN	ZS25032	93,42
38 1" 1/2"	1"7/8 12h UN	ZS25038	126,69

Straight union JIC 37° with o'ring

Racor macho-macho JIC 37° con junta

Gerade Verschraubung AGJ-AGJ mit Dichtung

Adapteur droit mâle JIC 37° avec o'ring



TUBO PIPE	ROSCA THREAD	Referencia Part n°	€
6 1/4"	7/16" 20h UNF	ZS26006OR	19,42
8 5/16"	1/2" 20h UNF	ZS26008OR	20,28
10 3/8"	9/16" 18h UNF	ZS26010OR	19,09
12 1/2"	3/4" 16h UNF	ZS26012OR	23,42
14-15-16 5/8"	7/8" 14h UNF	ZS26016OR	27,26
18-20 3/4"	1"1/16 12h UN	ZS26020OR	42,07
25 1"	1"5/16 12h UN	ZS26025OR	51,42
30-32 1" 1/4"	1"5/8 12h UN	ZS26032OR	84,94
38 1" 1/2"	1"7/8 12h UN	ZS26038OR	125,44

Metric adaptor male - male JIC 37°

Racor macho JIC 37° - macho Métrico

Gerade Einschraubversch. JIC 37° -AG metr.

Adapteur mâle JIC 37° - mâle Métrique

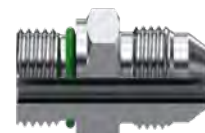

TUBO PIPE	ROSCA THREAD	Referencia Part n°	€
6 1/4"	M10x1 7/16" 20h UNF	ZS2400610	17,62
8 5/16"	M10x1 1/2" 20h UNF	ZS2400810*	16,25
8 5/16"	M12x1.5 1/2" 20h UNF	ZS2400812	16,04
8 5/16"	M14x1.5 1/2" 20h UNF	ZS2400814*	13,42
10 3/8"	M12x1.5 9/16" 18h UNF	ZS2401012	19,01
10 3/8"	M14x1.5 9/16" 18h UNF	ZS2401014	21,56
10 3/8"	M16x1.5 9/16" 18h UNF	ZS2401016	18,06
12 1/2"	M14x1.5 3/4" 16h UNF	ZS2401214	22,43
12 1/2"	M16x1.5 3/4" 16h UNF	ZS2401216	18,91
12 1/2"	M18x1.5 3/4" 16h UNF	ZS2401218	18,82
14-15-16 5/8"	M18x1.5 7/8" 14h UNF	ZS2401418	37,77
14-15-16 5/8"	M27x2 7/8" 14h UNF	ZS2401427*	23,94
14-15-16 5/8"	M22x1.5 7/8" 14h UNF	ZS2401622	39,75
18-20 3/4"	M22x1.5 1"1/16 12h UN	ZS2402022	37,54
18-20 3/4"	M27x2 1"1/16 12h UN	ZS2402027	38,68
25 1"	M27x2 1"5/16 12h UN	ZS2402527*	53,06
25 1"	M33x2 1"5/16 12h UN	ZS2402533	51,10
30-32 1" 1/4"	M42x2 1"5/8 12h UN	ZS2403242	78,38
38 1" 1/2"	M50x2 1"7/8 12h UN	ZS2403850	134,52

* Until end of stock / Hasta fin de existencias / Bis zum Ende des Lagerbestandes / Jusqu'à la fin du stock

Flare fittings JIC 37°

Racores JIC 37°
JIC - Verbindungen
Adapteurs JIC 37°

Straight adaptor male JIC 37° - male NPT pipe

Racor macho JIC 37° - macho NPT

Gerade Einschraubversch. AGJ-AGN

Adapteur mâle JIC 37° - mâle NPT (BRIGGS)



TUBO PIPE	ROSCA THREAD	Referencia Part n°	€
6	1/4" 7/16" 20h UNF 1/8" NPT	ZS2000610	12,70
6	1/4" 7/16" 20h UNF 1/4" NPT	ZS2000613	11,53
6	1/4" 7/16" 20h UNF 3/8" NPT	ZS2000617	19,74
8	5/16" 1/2" 20h UNF 1/8" NPT	ZS2000810	9,78
8	5/16" 1/2" 20h UNF 1/4" NPT	ZS2000813	12,59
8	5/16" 1/2" 20h UNF 3/8" NPT	ZS2000817	20,92
10	3/8" 9/16" 18h UNF 1/8" NPT	ZS2001010	14,55
10	3/8" 9/16" 18h UNF 1/4" NPT	ZS2001013	12,26
10	3/8" 9/16" 18h UNF 3/8" NPT	ZS2001017	14,47
10	3/8" 9/16" 18h UNF 1/2" NPT	ZS2001021	19,47
12	1/2" 3/4" 16h UNF 1/4" NPT	ZS2001213	20,10
12	1/2" 3/4" 16h UNF 3/8" NPT	ZS2001217	19,14
12	1/2" 3/4" 16h UNF 1/2" NPT	ZS2001221	19,36
12	1/2" 3/4" 16h UNF 3/4" NPT	ZS2001226	22,60
14-15-16	5/8" 7/8" 14h UNF 1/2" NPT	ZS2001621	24,59
14-15-16	5/8" 7/8" 14h UNF 3/4" NPT	ZS2001626	26,40
18-20	3/4" 1" 1/16 12h UN 1/4" NPT	ZS2002013	39,17
18-20	3/4" 1" 1/16 12h UN 1/2" NPT	ZS2002021	23,70
18-20	3/4" 1" 1/16 12h UN 3/4" NPT	ZS2002026	25,92
18-20	3/4" 1" 1/16 12h UN 1" NPT	ZS2002033	38,71
25	1" 1" 5/16 12h UN 3/4" NPT	ZS2002526	34,48
25	1" 1" 5/16 12h UN 1" NPT	ZS2002533	32,85
30-32	1" 1" 5/16 12h UN 1" 1/4 NPT	ZS2002542	72,33
30-32	1" 1/4 1" 5/8 12h UN 1" NPT	ZS2003233	77,88
30-32	1" 1/4 1" 5/8 12h UN 1 1/4" NPT	ZS2003242	65,43
38	1" 1/2 1" 7/8 12h UN 1" NPT	ZS2003833	84,30
38	1" 1/2 1" 7/8 12h UN 1 1/4" NPT	ZS2003842	92,36
38	1" 1/2 1" 7/8 12h UN 1 1/2" NPT	ZS2003848	72,10
50	2" 2" 1/2 12h UN 2" NPT	ZS2005060	117,92

Straight adaptor swivel female JIC 37° - male UNF

Hembra giratoria JIC 37° - macho UNF

Dichtkonus JIC 37° - UNF m

Adapteur femelle tournante JIC 37° - mâle UNF



TUBO PIPE	ROSCA (H) THREAD (F)	ROSCA (M) THREAD (M)	Referencia Part n°	€
6	1/4" 7/16" 20h UNF	7/16" 20h UNF	ZS38006	*
10	3/8" 9/16" 18h UNF	9/16" 18h UNF	ZS38010	*
12	1/2" 3/4" 16h UNF	3/4" 16h UNF	ZS38012	*
14-15-16	5/8" 7/8" 14h UNF	7/8" 14h UNF	ZS38016	*
18-20	3/4" 1" 1/16 12h UN	1" 1/16 12h UN	ZS38020	*
25	1" 1" 5/16 12h UN	1" 5/16 12h UN	ZS38025	*

*See prices in p.185 (O RING BOSS ADAPTORS) / *Ver precios en p.185 (ADAPTADORES O RING BOSS) / *Vgl. Sie die Preise auf S.185 (ADAPTER O RING BOSS) / *Prix à la p.185 (ADAPTEURS O RING BOSS)

Straight adaptor male JIC 37° - male BSP

Racor macho JIC 37° - macho BSP

Gerade Einschraubversch. AGJ-AGR

Adapteur mâle JIC 37° - mâle BSP équipé



TUBO PIPE	ROSCA THREAD	TUBO PIPE	ROSCA THREAD	Referencia Part n°	€
6	1/8" BSP	1/4" 7/16" 20h UNF		ZS2300610	12,09
6	1/4" BSP	1/4" 7/16" 20h UNF		ZS2300613	13,16
6	3/8" BSP	1/4" 7/16" 20h UNF		ZS2300617	20,93
6	1/2" BSP	1/4" 7/16" 20h UNF		ZS2300621	36,74
8	1/4" BSP	5/16" 1/2" 20h UNF		ZS2300813	18,37
8	3/8" BSP	5/16" 1/2" 20h UNF		ZS2300817	20,25
10	1/4" BSP	3/8" 9/16" 18h UNF		ZS2301013	13,71
10	3/8" BSP	3/8" 9/16" 18h UNF		ZS2301017	15,05
10	1/2" BSP	3/8" 9/16" 18h UNF		ZS2301021	20,74
12	1/4" BSP	1/2" 3/4" 16h UNF		ZS2301213	17,14
12	3/8" BSP	1/2" 3/4" 16h UNF		ZS2301217	17,45
12	1/2" BSP	1/2" 3/4" 16h UNF		ZS2301221	19,40
12	3/4" BSP	1/2" 3/4" 16h UNF		ZS2301226	35,39
14-15-16	3/8" BSP	5/8" 7/8" 14h UNF		ZS2301617	22,64
14-15-16	1/2" BSP	5/8" 7/8" 14h UNF		ZS2301621	25,85
14-15-16	3/4" BSP	5/8" 7/8" 14h UNF		ZS2301626	35,80
18-20	1/2" BSP	3/4" 1" 1/16 12h UN		ZS2302021	28,61
18-20	3/4" BSP	3/4" 1" 1/16 12h UN		ZS2302026	28,52
18-20	1" BSP	3/4" 1" 1/16 12h UN		ZS2302033	58,68
25	1/2" BSP	1" 1" 5/16 12h UN		ZS2302521*	34,17
25	3/4" BSP	1" 1" 5/16 12h UN		ZS2302526	33,90
25	1" BSP	1" 1" 5/16 12h UN		ZS2302533	58,19
25	1" 1/4 BSP	1" 1" 5/16 12h UN		ZS2302542	71,67
30-32	1" BSP	1" 1" 5/8 12h UN		ZS2303233	86,35
30-32	1" 1/4 BSP	1 1/4" 1" 5/8 12h UN		ZS2303242	82,28
38	1" 1/4 BSP	1 1/2" 1" 7/8 12h UN		ZS2303842	94,18
38	1" 1/2 BSP	1 1/2" 1" 7/8 12h UN		ZS2303848	118,14
38	2" BSP	1 1/2" 1" 7/8 12h UN		ZS2303860	145,27
40	1/2" BSP	2" 2" 1/2 12h UN	NEW	ZS2305021	173,74

*Until end of stock / Hasta fin de existencias / Bis zum Ende des Lagerbestandes / Jusqu'à la fin du stock

Straight adaptor male BSP - swivel female JIC 37°

Racor macho BSP - hembra giratoria JIC 37°

Adapter DKJ-AGR

Adapteur mâle BSP - femelle tournante JIC 37°



TUBO PIPE	ROSCA THREAD	Referencia Part n°	€
6	1/4" 1/8" BSP	7/16" 20h UNF	ZS1800610 18,96
8	5/16" 1/4" BSP	1/2" 20h UNF	ZS1800813 20,39
10	3/8" 1/4" BSP	9/16" 18h UNF	ZS1801013 19,39
10	3/8" 3/8" BSP	9/16" 18h UNF	ZS1801017 24,96
10	3/8" 1/2" BSP	9/16" 18h UNF	ZS1801021 29,46
12	1/2" 3/8" BSP	3/4" 16h UNF	ZS1801217 24,80
14-15-16	5/8" 1/2" BSP	H 3/4" 16h UNF	ZS1801221 32,82
14-15-16	5/8" 1/2" BSP	7/8" 14h UNF	ZS1801621 30,52
18-20	3/4" 3/4" BSP	1" 1/16 12h UNF	ZS1802026 45,53
25	1" 1" BSP	1" 5/16 12h UNF	ZS1802533 64,24
30-32	1" 1/4 1" 1/4 BSP	1" 5/8 12h UNF	ZS1803242 94,77
38	1" 1/2 1" 1/2 BSP	1" 7/8 12h UNF	ZS1803848 139,81

Flare fittings JIC 37°

Racores JIC 37°
JIC - Verbindungen
Adapteurs JIC 37°

Straight adaptor male JIC 37° - male BSPT

Racor macho JIC 37° - macho BSPT

Gerade Einschraubverschr. AGJ-AGR KEGEL

Adapteur mâle JIC 37° - mâle BSPT



Adaptor male JIC - swivel female JIC

Adaptador Macho JIC - hembra giratoria JIC 37°

JIC m - w Ü-Mutter JIC

Adapteur mâle JIC x femelle tournante JIC



TUBO PIPE	ROSCA THREAD		Referencia Part n°	€
6	1/4"	7/16" 20h UNF	1/8" BSPT	ZS2100610 13,23
6	1/4"	7/16" 20h UNF	1/4" BSPT	ZS2100613 11,10
8	5/16"	1/2" 20h UNF	1/8" BSPT	ZS2100810 11,70
8	5/16"	1/2" 20h UNF	1/4" BSPT	ZS2100813 12,99
8	5/16"	1/2" 20h UNF	3/8" BSPT	ZS2100817 14,09
10	3/8"	9/16" 18h UNF	1/4" BSPT	ZS2101013 15,08
10	3/8"	9/16" 18h UNF	3/8" BSPT	ZS2101017 14,93
10	3/8"	9/16" 18h UNF	1/2" BSPT	ZS2101021 19,35
12	1/2"	3/4" 16h UNF	1/4" BSPT	ZS2101213 19,73
12	1/2"	3/4" 16h UNF	3/8" BSPT	ZS2101217 18,36
12	1/2"	3/4" 16h UNF	1/2" BSPT	ZS2101221 20,21
12	1/2"	3/4" 12h UNF	3/4" BSPT	ZS2101226 23,11
14-15-16	5/8"	7/8" 14h UNF	3/8" BSPT	ZS2101617 22,99
14-15-16	5/8"	7/8" 14h UNF	1/2" BSPT	ZS2101621 23,04
14-15-16	5/8"	7/8" 14h UNF	3/4" BSPT	ZS2101626 25,22
18-20	3/4"	1" 1/16 12h UN	1/2" BSPT	ZS2102021 24,43
18-20	3/4"	1" 1/16 12h UN	3/4" BSPT	ZS2102026 24,27
18-20	3/4"	1" 1/16 12h UN	1" BSPT	ZS2102033 40,45
25	1"	1" 5/16 12h UN	3/4" BSPT	ZS2102526 42,86
25	1"	1" 5/16 12h UN	1" BSPT	ZS2102533 41,36
30-32	1" 1/4	1" 5/8 12h UN	1" BSPT	ZS2103233 59,70
30-32	1" 1/4	1" 5/8 12h UN	1 1/4" BSPT	ZS2103242 62,88
38	1" 1/2	1" 7/8 12h UN	1 1/2" BSPT	ZS2103848 82,09

TUBO PIPE	ROSCA THREAD		Referencia Part n°	€
6	1/4"	7/16" 20 UNF	7/16" 20 UNF	ZS7400606 16,72
8	5/16"	1/2" 20 UNF	1/2" 20 UNF	ZS7400808 17,18
10	3/8"	9/16" 18 UNF	9/16" 18 UNF	ZS7401010 20,55
12	1/2"	3/4" 16 UNF	3/4" 16 UNF	ZS7401212 23,99
14-15-16	5/8"	7/8" 14 UNF	7/8" 14 UNF	ZS7401616 27,39
18-20	3/4"	1" 1/16 12 UNF	1" 1/16 12 UNF	ZS7402020 39,94
25	1"	1" 5/16 12 UNF	1" 5/16 12 UNF	ZS7402525 51,98

Straight adaptor male JIC 37° - fixed female NPT

Racor macho JIC 37° - hembra fija NPT

Gerade Einschraubverschr. m JIC 37° - w fest NPT

Adapteur mâle JIC 37° - femelle fixe NPT



TUBO PIPE	ROSCA THREAD		Referencia Part n°	€
6	1/4"	7/16"-20h UNF	1/8" NPT	ZS2950610 16,72
6	1/4"	7/16"-20h UNF	1/4" NPT	ZS2950613 22,79
6	3/8"	7/16"-20h UNF	3/8" NPT	NEW ZS2950617 36,14
6	1/2"	7/16"-20h UNF	1/2" NPT	NEW ZS2950621 38,35
8	5/16"	1/2"-20h UNF	1/4" NPT	ZS2950813 23,27
8	5/16"	1/2"-20h UNF	3/8" NPT	ZS2950817 28,02
10	3/8"	9/16"-20h UNF	1/4" NPT	ZS2951013 27,85
10	3/8"	9/16"-20h UNF	3/8" NPT	ZS2951017 27,92
10	1/2"	9/16"-20h UNF	1/2" NPT	NEW ZS2951021 39,71
12	1/2"	3/4"-20h UNF	1/4" NPT	ZS2951213 22,90
12	1/2"	3/4"-20h UNF	3/8" NPT	ZS2951217 20,64
12	1/2"	3/4"-20h UNF	1/2" NPT	ZS2951221 28,85
14-15-16	5/8"	7/8"-14h UNF	1/2" NPT	ZS2951621 33,06
18-20	3/4"	1" 1/16-12h UNF	3/4" NPT	ZS2952026 38,74
18-20	3/4"	1" 1/16-12h UNF	1" NPT	ZS2952033 54,27
25	1"	1" 5/16-12 UNF	3/4" NPT	NEW ZS2952526 44,35
25	1"	1" 5/16-12 UNF	1" NPT	ZS2952533 50,25
25	1"	1" 5/16-12 UN	1" 1/4 NPT	ZS2952542 73,71
30-32	1" 1/4	1" 5/8-12h UNF	1" NPT	NEW ZS2953233 55,87
30-32	1" 1/4	1" 5/8-12h UNF	1" 1/4 NPT	ZS2953242 74,45
38	1" 1/2	1" 7/8 12h UN	1" 1/2 NPT	NEW ZS2953842 81,04
38	1 1/2	1" 7/8-12h UNF	1" 1/2 NPT	ZS2953848 88,53
50	2" 1/2	2" 1/2 12h UNF	2" NPT	NEW ZS2955060 216,55

Flare fittings JIC 37°

Racores JIC 37°
JIC - Verbindungen
Adapteurs JIC 37°

Reducer adaptor male JIC 37° - swivel female JIC 37°

Racor reducción macho JIC 37° - hembra giratoria JIC 37°

Reduziernippel m - w Ü-Mutter JIC 37°

Adapteur réduction mâle JIC 37° - femelle tournante JIC 37°



ROSCA (H) THREAD (F)	ROSCA (M) THREAD (M)	TUBO (H) PIPE (F)	TUBO (M) PIPE (M)	Referencia Part n°	€
9/16" 18h UNF	7/16" 20h UNF	10	6	ZS2911006	16,70
9/16" 18h UNF	3/4" 16h UNF	10	12	ZS2911012	32,69
9/16" 18h UNF	7/8" 14h UNF	10	14-15-16	ZS2911016	27,35
3/4" 16h UNF	7/16" 20h UNF	12	6	ZS2911206	19,15
3/4" 16h UNF	1/2" 20h UNF	12	8	ZS2911208	20,27
3/4" 16h UNF	9/16" 18h UNF	12	10	ZS2911210	24,30
3/4" 16h UNF	1"1/16 12h UN	12	18-20	ZS2911220	36,56
3/4" 16h UNF	1"5/16 12h UN	12	25	ZS2911225	40,91
7/8" 14h UNF	7/16" 20h UNF	14-15-16	6	ZS2911606	21,18
7/8" 14h UNF	9/16" 18h UNF	14-15-16	10	ZS2911610	25,11
7/8" 14h UNF	1"1/16 12h UN	14-15-16	18-20	ZS2911620	33,54
1"1/16 12h UN	7/16" 20h UNF	18-20	6	ZS2912006	32,31
1"1/16 12h UN	9/16" 18h UNF	18-20	10	ZS2912010	29,30
1"1/16 12h UN	3/4" 16h UNF	18-20	12	ZS2912012	27,37
1"5/16 12h UN	1"1/16 12h UN	25	18-20	ZS2912520	51,70
1"5/8 12h UN	7/8" 14h UNF	32	16	ZS2913216	73,51
1"5/8 12h UN	1"5/16 12h UN	32	20	ZS2913220	68,12
1"5/8 12h UN	1"5/16 12h UN	30-32	25	ZS2913225	74,71
1"7/8 14h UNF	1"5/8 12h UN	38	32	NEW ZS2913832	85,01

Material could be delivered with loose or crimped nut / Pueden ser suministradas con tuerca libre o prensada / Material could be delivered with loose or crimped nut / Peut être livrée avec écrou libre ou pré-serti

Reducer adaptor male JIC 37° - fixed female JIC 37°

Racor reducción macho JIC 37 - hembra fija JIC 37°

Reduzieranschlüsse m - w JIC 37°

Adapteur réduction mâle JIC 37° - femelle fixe JIC 37°



TUBO (H) PIPE (F)	TUBO (M) PIPE (M)	ROSCA (H) THREAD (F)	ROSCA (M) THREAD (M)	Referencia Part n°	€
6	8	7/16" 20h UNF	1/2" 20h UNF	ZS2900608	17,17
6	10	7/16" 20h UNF	9/16" 18 UNF	ZS2900610	20,84
6	12	7/16" 20h UNF	3/4" 16h UNF	ZS2900612	27,51
6	25	7/16" 20h UNF	1"5/16 12h UN	ZS2900625	42,61
8	14-15-16	1/2" 20h UNF	7/8" 14h UNF	ZS2900816	24,26
8	18-20	1/2" 20h UNF	1"1/16 12h UN	ZS2900820	38,41
8	25	1/2" 20h UNF	1"5/16 12h UN	ZS2900825	41,13
10	8	9/16" 18h UNF	1/2" 20h UNF	ZS2901008	23,29
10	25	9/16" 18h UNF	1"5/16 12h UN	ZS2901025	41,52
12	30-32	3/4" 16h UNF	1"5/8 12h UN	ZS2901232	62,90
12	38	3/4" 16h UNF	1"7/8 12h UN	ZS2901238	82,55
14-15-16	12	7/8" 14h UNF	3/4" 16h UNF	ZS2901612	27,81
14-15-16	25	7/8" 14h UNF	1"5/16 12h UN	ZS2901625	48,97
14-15-16	30-32	7/8" 14h UNF	1"5/8 12h UN	ZS2901632	65,87
14-15-16	38	7/8" 14h UNF	1"7/8 12h UN	ZS2901638	79,76
18-20	30-32	1"1/16 12h UN	1"5/16 12h UN	ZS2902025	47,55
18-20	30-32	1"1/16 12h UN	1"5/8 12h UN	ZS2902032	68,60
25	30-32	1"5/16 12h UN	1"5/8 12h UN	ZS2902532	72,00
25	38	1"5/16 12h UN	1"7/8 12h UN	ZS2902538	76,81
38	30-32	1"7/8 12h UN	1"5/8 12h UN	ZS2903832	120,57

Flare fittings JIC 37°

Racores JIC 37°
JIC - Verbindungen
Adpteurs JIC 37°

Straight adaptor swivel female JIC 37° - male NPT pipe

Hembra giratoria JIC 37° - macho NPT

Dichtkopf mit Ü-Mutter JIC 37° - NPT m

Adpteur femelle tournante JIC 37° - mâle NPT



Straight adaptor swivel female JIC 37°

Racor hembra giratoria - hembra giratoria JIC 37°

Adapter JIC 37° W mit Ü-Muttern

Adpteur femelle tournante JIC 37°



ROSCA THREAD		Referencia Part n°	€
7/16"-20h UNF	1/4" NPT	ZS1850613	23,32
9/16"-18h UNF	3/8" NPT	ZS1851017	22,90
3/4"-16h UNF	3/8" NPT	ZS1851217	22,89
3/4"-16h UNF	1/2" NPT	ZS1851221	33,51
7/8"-14h UNF	1/2" NPT	ZS1851621	30,81
1"1/16-12h UNF	3/4" NPT	ZS1852026	34,80
1"5/16-12h UNF	1" NPT	ZS1852533	61,54
1" 7/8-12h UN	1" 1/2 NPT	ZS1853848	117,05

TUBO PIPE		ROSCA THREAD	Referencia Part n°	€
6	1/4"	7/16" 20h UNF	ZS73006	20,17
8	5/16"	1/2" 20h UNF	ZS73008	20,50
10	3/8"	9/16" 18h UNF	ZS73010	22,60
12	1/2"	3/4" 16h UNF	ZS73012	23,79
14-15-16	5/8"	7/8" 14h UNF	ZS73016	29,49
18-20	3/4"	1"1/16 12h UN	ZS73020	45,53
25	1"	1"5/16 12h UN	ZS73025	61,40
32	1"1/4	1"5/8 12h UN	ZS73032	112,17
38	1"1/2	1"7/8 12h UN	ZS73038	130,78

FKM green o'ring for Metric thread

Juntas tóricas FKM verde para macho Métrico

O-Ringe FKM grün für metr. Verb.

Joint torique FKM vert pour filetage métrique



FKM green o'ring for BSP thread

Juntas tóricas FKM verde para macho BSP

O-Ringe FKM grün für BSP

Joint torique FKM vert pour mâle BSP



ROSCA THREAD	Referencia Part n°	€
M10x1	JVMET10	0,24
M14x1.5	JVMET14	0,32
M16x1.5	JVMET16	0,37
M18x1.5	JVMET18	0,46
M22x1.5	JVMET22	0,54
M27x2	JVMET27	0,71
M33x2	JVMET33	1,71
M42x2	JVMET42	3,23
M50x2	JVMET50	1,50

ROSCA THREAD	Referencia Part n°	€
1/8" BSP	JVMBSP02	0,27
1/4" BSP	JVMBSP04	0,37
3/8" BSP	JVMBSP06	0,46
1/2" BSP	JVMBSP08	0,64
3/4" BSP	JVMBSP12	0,71
1" BSP	JVMBSP16	1,56
1"1/4 BSP	JVMBSP20	1,97
1"1/2 BSP	JVMBSP24	2,22
2" BSP	JVMBSP32	3,29

FKM green o'ring for UNF thread

Juntas tóricas FKM verde para rosca UNF

O- Ringe FKM grün für UNF

Joint torique FKM vert pour filetage UNF



FKM green o'ring for JIC male thread

Juntas para Macho JIC FKM verde

Dichtungen für Außengewinde JIC 37° FKM grün

Joint FKM vert pour mâle JIC



ROSCA THREAD	Referencia Part n°	€
7/16" UNF	JVUNF06	0,36
1/2" UNF	JVUNF08	0,60
9/16" UNF	JVUNF10	0,92
3/4" UNF	JVUNF12	0,86
7/8" UNF	JVUNF16	1,12
1" 1/16 UNF	JVUNF20	1,31
1"5/16 UNF	JVUNF25	3,16
1" 5/8 UNF	JVUNF32	5,05
1" 7/8 UNF	JVUNF38	4,08

ROSCA THREAD	Referencia Part n°	€
7/16" 20h UNF	JTVJIC07	0,17
9/16" 18h UNF	JTVJIC09	0,17
3/4" 16h UNF	JTVJIC12	0,22
1"1/16 12h UNF	JTVJIC17	0,29
1" 5/16 12h UN	JTVJIC21	0,28
1"5/8 12h UNF	JTVJIC26	0,39

Flare fittings JIC 37°

Racores JIC 37°
JIC - Verbindungen
Adapteurs JIC 37°

90° Elbow male - male JIC 37°

Codo 90° macho - macho JIC 37°

90° Winkel AGJ-AGJ

Coude 90° mâle - mâle JIC 37°



TUBO PIPE	ROSCA THREAD	Referencia Part n°	€
6	1/4"	7/16" 20h UNF	ZS50006 21,83
8	5/16"	1/2" 20h UNF	ZS50008 23,66
10	3/8"	9/16" 18h UNF	ZS50010 21,05
12	1/2"	3/4" 16h UNF	ZS50012 37,03
14-15-16	5/8"	7/8" 14h UNF	ZS50016 56,93
18-20	3/4"	1"1/16 12h UN	ZS50020 61,37
25	1"	1"5/16 12h UN	ZS50025 75,44
30-32	1"1/4	1"5/8 12h UN	ZS50032 114,98
38	1"1/2	1"7/8 12h UN	ZS50038 203,40

90° Elbow swivel female JIC 37° - male JIC 37°

Codo 90° macho JIC 37° - hembra giratoria JIC 37°

90° Winkel DKJ-AGJ

Coude 90° mâle JIC 37° - femelle tournante JIC 37°



TUBO PIPE	ROSCA THREAD	Referencia Part n°	€
6	1/4" 7/16" 20h UNF	7/16" 20h UNF	ZS67506 26,34
8	5/16" 1/2" 20h UNF	1/2" 20h UNF	ZS67508 28,39
10	3/8" 9/16" 18h UNF	9/16" 18h UNF	ZS67510 31,78
12	1/2" 3/4" 16h UNF	3/4" 16h UNF	ZS67512 40,78
14-15-16	5/8" 7/8" 14h UNF	7/8" 14h UNF	ZS67516 45,97
18-20	3/4" 1"1/16 12h UNF	1"1/16 12h UNF	ZS67520 71,03
25	1" 1"5/16 12h UNF	1"5/16 12h UNF	ZS67525 124,89
30-32	1"1/4 1"5/8 12h UNF	1"5/8 12h UNF	ZS67532 138,86
38	1"1/2 1"7/8 12h UNF	1"7/8 12h UNF	ZS67538 180,03

90° Elbow male JIC 37° - fixed female NPT

Codo 90° macho JIC 37° - hembra fija NPT

90° Winkel m JIC 37° - w fest NPT

Coude 90° JIC 37° - femelle fixe NPT



TUBO PIPE	ROSCA THREAD	Referencia Part n°	€
6	1/4" 7/16" 20h UNF	1/4" NPT	ZS7000613 37,58
10	3/8" 9/16" 18h UNF	3/8" NPT	ZS7001017 39,83
12	1/2" 3/4" 16h UNF	1/2" NPT	ZS7001221 64,80
18-20	3/4" 1"1/16 12h UNF	3/4" NPT	ZS7002026 86,43
25	1" 1"5/16 12h UNF	1" NPT	ZS7002533 155,87

90° Elbow male - male JIC 37° with o'ring

Codo 90° macho - macho JIC 37° con junta

90° Winkel m - m JIC 37° mit Dichtung

Coude 90° mâle - mâle JIC 37° avec o'ring



TUBO PIPE	ROSCA THREAD	Referencia Part n°	€
6	1/4"	7/16" 20h UNF	ZS500060R 37,98
8	5/16"	1/2" 20h UNF	ZS500080R 41,14
10	3/8"	9/16" 18h UNF	ZS500100R 43,02
12	1/2"	3/4" 16h UNF	ZS500120R 49,76
14-15-16	5/8"	7/8" 14h UNF	ZS500160R 70,51
18-20	3/4"	1"1/16 12h UN	ZS500200R 94,93
25	1"	1"5/16 12h UN	ZS500250R 137,35
30-32	1"1/4	1"5/8 12h UN	ZS500320R 168,78
38	1"1/2	1"7/8 12h UN	ZS500380R 291,37

90° Bulkhead elbow male - male JIC 37°

Codo 90° pasatabiques macho - macho JIC 37°

90° Schottverschraubung m - m JIC 37°

Coude 90° passe cloison mâle-mâle JIC 37°



TUBO PIPE	ROSCA THREAD	Referencia Part n°	€
6	1/4" 7/16" - 20h UNF	7/16" - 20h UNF	ZS65006 57,63
8	5/16" 1/2" - 20h UNF	1/2" - 20h UNF	ZS65008 64,33
10	3/8" 9/16" - 18h UNF	9/16" - 18h UNF	ZS65010 64,16
12	1/2" 3/4" - 16h UNF	3/4" - 16h UNF	ZS65012 82,42
14-15-16	5/8" 7/8" - 14h UNF	7/8" - 14h UNF	ZS65016 100,00
18-20	3/4" 1"1/16 - 12h UN	1"1/16 - 12h UN	ZS65020 156,57
25	1" 1"5/16 - 12h UN	1"5/16 - 12h UN	ZS65025 177,63

90° Adjustable stud elbow male JIC 37° - male BSP

Codo 90° regulable macho JIC 37° - macho BSP

90° Winkel einstellbar m JIC 37° - m BSP

Coude 90° orientable mâle JIC 37° - mâle BSP



TUBO PIPE	ROSCA THREAD	Referencia Part n°	€
6	1/4" 7/16" 20h UNF	1/4" BSP	ZS5700613 26,22
6	1/4" 1/2" 20h UNF	1/4" BSP	ZS5700813 31,17
10	3/8" 9/16" 18h UNF	1/4" BSP	ZS5701013 44,55
10	3/8" 9/16" 18h UNF	3/8" BSP	ZS5701017 45,26
12	1/2" 3/4" 20h UNF	3/8" BSP	ZS5701217 51,78
12	1/2" 3/4" 16h UNF	1/2" BSP	ZS5701221 59,53
14-15-16	5/8" 7/8" 14h UNF	1/2" BSP	ZS5701621 67,39
18-20	3/4" 1"1/16 12h UN	3/4" BSP	ZS5702026 98,75
25	1" 1"5/16 12h UN	1" BSP	ZS5702533 149,53
30-32	1"1/4 1"5/8 12h UN	1"1/4 BSP	ZS5703242 466,56
38	1"1/2 1"7/8 12h UN	1"1/2 BSP	ZS5703848 660,34

Flare fittings JIC 37°

Racores JIC 37°
JIC - Verbindungen
Adapteurs JIC 37°

90° Adjustable elbow male O'Ring Boss -male JIC 37°

Codo 90° regulable macho O'Ring Boss - macho JIC 37

90° Winkel einstellbar m O'Ring Boss - m JIC 37°

Coude 90° orientable mâle O'Ring Boss - mâle JIC 37°



TUBO PIPE	ROSCA THREAD	Referencia Part n°	€
6	1/4" 7/16"-20h UNF	ZS57506	*
8	5/16" 1/2"-20h UNF	ZS57508	*
10	3/8" 9/16"-18h UNF	ZS57510	*
12	1/2" 3/4"-16h UNF	ZS57512	*
14-15-16	5/8" 7/8"-14h UNF	ZS57516	*
18-20	3/4" 1"1/16-12h UN	ZS57520	*
25	1" 1"5/16-12h UN	ZS57525	*

*See prices in p. 186 (O'RING BOSS ADAPTORS) / *Ver precios en p. 186 (ADAPTADORES O'RING BOSS) / *Vgl. Sie die Preise auf S.186 (ADAPTER O'RING BOSS) / *Voir prix à la p. 186 (ADAPTEURS O'RING BOSS)

90° Elbow male JIC 37° - male BSPT

Codo 90° macho JIC 37° - macho BSPT

90° Winkel AGJ-AGR KEGEL

Coude 90° mâle JIC 37° - mâle BSPT



TUBO PIPE	ROSCA THREAD	Referencia Part n°	€
6	1/4" 1/8" BSPT	ZS5500610	29,38
6	1/4" 1/4" BSPT	ZS5500613	29,96
8	5/16" 1/8" BSPT	ZS5500810	30,70
8	5/16" 1/4" BSPT	ZS5500813	29,19
10	3/8" 1/4" BSPT	ZS5501013	26,15
10	3/8" 3/8" BSPT	ZS5501017	36,32
10	3/8" 1/2" BSPT	ZS5501021	42,88
12	1/2" 1/4" BSPT	ZS5501213	40,83
12	1/2" 3/8" BSPT	ZS5501217	48,22
12	1/2" 1/2" BSPT	ZS5501221	37,36
14-15-16	5/8" 3/8" BSPT	ZS5501617	47,41
14-15-16	5/8" 1/2" BSPT	ZS5501621	53,31
14-15-16	5/8" 3/4" BSPT	ZS5501626	90,48
18-20	3/4" 1/2" BSPT	ZS5502021	61,82
18-20	3/4" 3/4" BSPT	ZS5502026	64,67
25	1" 3/4" BSPT	ZS5502526	112,98
25	1" 1" BSPT	ZS5502533	100,41
30-32	1" 1/4" 1 1/4" BSPT	ZS5503242*	181,00

* Until end of stock / Hasta fin de existencias / Bis zum Ende des Lagerbestandes / Jusqu'à la fin du stock

90° Elbow male NPT - swivel female JIC 37°

Codo 90° macho NPT - hembra giratoria JIC 37°

90° Winkel m NPT - W mit Ü-Mutter JIC°

Coude 90° mâle NPT - femelle tournante JIC 37°



ROSCA THREAD	Referencia Part n°	€	
1/8" NPT	7/16"-20h UNF	ZS5950610	29,69
1/4" NPT	1/2"-20h UNF	ZS5950813	32,75
1/4" NPT	9/16"-18h UNF	ZS5951013	33,61
3/8" NPT	3/4"-16h UNF	ZS5951217	46,04
1/2" NPT	7/8"-14h UNF	ZS5951621	60,70
3/4" NPT	1"1/16"-12h UN	ZS5952026	93,33
1" NPT	1"5/16"-12h UN	ZS5952533	114,48

90° Elbow male JIC 37° - male NPT

Codo 90° macho JIC 37° - macho NPT

90° Winkel AGJ-AGN

Coude 90° mâle JIC 37° - mâle NPT



TUBO PIPE	ROSCA THREAD	Referencia Part n°	€
6	1/4" 1/8" NPT	ZS5250610	28,18
6	1/4" 1/4" NPT	ZS5250613	26,54
8	5/16" 1/8" NPT	ZS5250810	24,09
8	5/16" 1/4" NPT	ZS5250813	23,50
10	3/8" 1/4" NPT	ZS5251013	21,84
10	3/8" 3/8" NPT	ZS5251017	27,07
10	3/8" 1/2" NPT	ZS5251021	36,20
12	1/2" 1/4" NPT	ZS5251213	33,35
12	1/2" 3/8" NPT	ZS5251217	38,09
12	1/2" 1/2" NPT	ZS5251221	34,98
14-15-16	5/8" 3/8" NPT	ZS5251617	47,06
14-15-16	5/8" 1/2" NPT	ZS5251621	45,44
14-15-16	5/8" 3/4" NPT	ZS5251626	53,20
18-20	3/4" 1/2" NPT	ZS5252021	60,92
18-20	3/4" 3/4" NPT	ZS5252026	57,80
25	1" 3/4" NPT	ZS5252526	76,27
25	1" 1" NPT	ZS5252533	81,11

Flare fittings JIC 37°

Racores JIC 37°
JIC - Verbindungen
Adapteurs JIC 37°

45° Elbow male JIC 37° - swivel female JIC 37°

Codo 45° macho JIC 37° - hembra giratoria JIC 37°

45° Winkel m JIC 37° - w Ü-Mutter JIC 37°

Coude 45° mâle JIC 37° - femelle tournante JIC 37°



TUBO PIPE	ROSCA THREAD		Referencia Part n°	€
6	1/4"	7/16" 20h UNF	7/16" 20h UNF	ZS69006 18,81
8	5/16"	1/2" 20h UNF	1/2" 20h UNF	ZS69008 22,13
10	3/8"	9/16" 18h UNF	9/16" 18h UNF	ZS69010 24,31
12	1/2"	3/4" 16h UNF	3/4" 16h UNF	ZS69012 43,49
14-15-16	5/8"	7/8" 14h UNF	7/8" 14h UNF	ZS69016 59,47
18-20	3/4"	1" 1/16 12h UN	1" 1/16 12h UN	ZS69020 190,80
25	1"	1" 5/16 12h UN	1" 5/16 12h UN	ZS69025 278,84

45° Adjustable stud elbow male - male JIC 37°

Codo 45° regulable macho - macho JIC 37°

45° Winkel JIC 37° m einstellbar - m

Coude 45° orientable mâle - mâle JIC 37°



TUBO PIPE	ROSCA THREAD		Referencia Part n°	€
6	1/4"	7/16" - 20h UNF	7/16" - 20h UNF	ZS77506 74,17
8	5/16"	1/2" - 20h UNF	1/2" - 20h UNF	ZS77508 76,75
10	3/8"	9/16" - 18h UNF	9/16" - 18h UNF	ZS77510 70,47
12	1/2"	3/4" - 16h UNF	3/4" - 16h UNF	ZS77512 87,79
14-15-16	5/8"	7/8" - 14h UNF	7/8" - 14h UNF	ZS77516 160,14
18-20	3/4"	1" 1/16 - 12h UN	1" 1/16 - 12h UN	ZS77520 333,35

45° Elbow male JIC 37° - male NPT pipe

Codo 45° macho JIC 37° - macho NPT

45° Winkel m JIC 37° - m NPT

Coude 45° mâle JIC 37° - mâle NPT



TUBO PIPE	ROSCA THREAD		Referencia Part n°	€
6	1/4"	1/4" NPT	7/16" 20h UNF	ZS7250613 17,05
10	3/8"	3/8" NPT	9/16" 18h UNF	ZS7251017 25,35
12	1/2"	1/2" NPT	3/4" 16h UNF	ZS7251221 38,37
18-20	3/4"	3/4" NPT	1" 1/16 12h UN	ZS7252026 59,53
25	1"	1" NPT	1" 5/16 12h UN	ZS7252533 75,98

Flare fittings JIC 37°

Racores JIC 37°
JIC - Verbindungen
Adapteurs JIC 37°

Union tee male JIC 37°

TE macho - macho - macho JIC 37°

T-Verschraubung AGJ

Té égal mâle JIC 37°



TUBO PIPE	ROSCA THREAD	Referencia Part n°	€
6	1/4"	7/16" 20h UNF	ZS50506 32,30
8	5/16"	1/2" 20h UNF	ZS50508 39,41
10	3/8"	9/16" 18h UNF	ZS50510 39,78
12	1/2"	3/4" 16h UNF	ZS50512 49,57
14-15-16	5/8"	7/8" 14h UNF	ZS50516 54,19
18-20	3/4"	1"1/16 12h UN	ZS50520 76,51
25	1"	1"5/16 12h UN	ZS50525 109,41
30-32	1" 1/4	1"5/8 12h UN	ZS50532 162,19
38	1" 1/2	1"7/8 12h UN	ZS50538 249,34

Tee male JIC 37° - male JIC 37° - swivel nut JIC 37°

TE macho - macho - hembra giratoria JIC 37°

Einstellbare T-Anschlußverschraubungen AGJ-AGJ-DKJ

Té mâle JIC 37° - mâle JIC 37° - femelle tournante JIC 37° au latéral



TUBO PIPE	ROSCA THREAD	Referencia Part n°	€
6	1/4"	7/16" 20h UNF	ZS68006 39,21
8	5/16"	1/2" 20h UNF	ZS68008 39,50
10	3/8"	9/16" 18h UNF	ZS68010 44,26
12	1/2"	3/4" 16h UNF	ZS68012 50,05
14-15-16	5/8"	7/8" 14h UNF	ZS68016 76,49
18-20	3/4"	1"1/16 12h UN	ZS68020 93,68
25	1"	1"5/16 12h UN	ZS68025 135,74
32	1" 1/4	1"5/8 12h UN	ZS68032 216,54
38	1" 1/2	1"7/8 12h UN	ZS68038 294,55

Tee male JIC 37° - male JIC 37° - male NPT

TE macho JIC 37° - macho JIC 37° - macho NPT

T-Verschraubungen m JIC 37° - m JIC 37° - m NPT

Té mâle JIC 37° - mâle JIC 37° - mâle NPT



ROSCA THREAD	Referencia Part n°	€
7/16"-20h UNF 7/16"-20h UNF 1/8" NPT	ZS6300610	33,54
1/2"-20h UNF 1/2"-20h UNF 1/4" NPT	ZS6300813	45,16
9/16"-18h UNF 9/16"-18h UNF 1/4" NPT	ZS6301013	54,33
3/4"-16h UNF 3/4"-16h UNF 3/8" NPT	ZS6301217	61,43
7/8"-14h UNF 7/8"-14h UNF 1/2" NPT	ZS6301621	73,06
1"1/16-12h UN 1"1/16-12h UN 3/4" NPT	ZS6302026	109,30
1"5/16-12h UN 1"5/16-12h UN 1" NPT	ZS6302533	121,26

Union tee male JIC 37° with o'ring

TE macho - macho - macho JIC 37° con junta

T-Verschraubungen m - m - m - JIC 37° mit Dichtung

Té égal mâle JIC 37° avec o'ring



TUBO PIPE	ROSCA THREAD	Referencia Part n°	€
6	1/4"	7/16" 20h UNF	ZS505060R 51,62
8	5/16"	1/2" 20h UNF	ZS505080R 52,88
10	3/8"	9/16" 18h UNF	ZS505100R 58,65
12	1/2"	3/4" 16h UNF	ZS505120R 69,61
14-15-16	5/8"	7/8" 14h UNF	ZS505160R 85,36
18-20	3/4"	1"1/16 12h UN	ZS505200R 119,26
25	1"	1"5/16 12h UN	ZS505250R 179,00
30-32	1" 1/4	1"5/8 12h UN	ZS505320R 222,79
38	1" 1/2	1"7/8 12h UN	ZS505380R 340,46

Tee male JIC 37° - swivel nut JIC 37° - male JIC 37°

TE macho - hembra giratoria - macho JIC 37°

Einstellbare T-Anschlußverschraubung AGJ-DKJ-AGJ

Té mâle JIC 37° - femelle tournante JIC 37° - mâle JIC 37°



TUBO PIPE	ROSCA THREAD	Referencia Part n°	€
6	1/4"	7/16" 20h UNF	ZS68506 39,21
8	5/16"	1/2" 20h UNF	ZS68508 39,50
10	3/8"	9/16" 18h UNF	ZS68510 44,26
12	1/2"	3/4" 16h UNF	ZS68512 50,05
14-15-16	5/8"	7/8" 14h UNF	ZS68516 76,49
18-20	3/4"	1"1/16 12h UN	ZS68520 93,68
25	1"	1"5/16 12h UN	ZS68525 151,69
32	1" 1/4	1"5/8 12h UN	ZS68532 216,54
38	1" 1/2	1"7/8 12h UN	ZS68538 294,55

Tee male JIC 37° - male NPT - male JIC 37°

TE macho JIC 37° - macho NPT - macho JIC 37°

T-Verschraubungen m JIC 37° - m NPT - m JIC 37°

Té mâle JIC 37° - mâle NPT - mâle JIC 37°



ROSCA THREAD	Referencia Part n°	€
7/16"-20h UNF 1/8" NPT 7/16"-20h UNF	ZS6250610	42,26
1/2"-20h UNF 1/4" NPT 1/2"-20h UNF	ZS6250813	45,43
9/16"-18h UNF 1/4" NPT 9/16"-18h UNF	ZS6251013	66,81
3/4"-16h UNF 3/8" NPT 3/4"-16h UNF	ZS6251217	74,74
7/8"-14h UNF 1/2" NPT 7/8"-14h UNF	ZS6251621	85,48
1"1/16-12h UN 3/4" NPT 1"1/16-12h UN	ZS6252026	101,23
1"5/16-12h UN 1" NPT 1"5/16-12h UN	ZS6252533	121,26

DICSA

TrΔle®



Sistema logístico inteligente. Optimizamos tus envíos.
Cada día más cerca de ti. Compañía global.

Closer to you everyday. Worldwide company.
Smart logistics system. We optimize delivery operations.



www.dicsaes.com

SCH TrΔle® Rigid pipe | **143**

Tubo TrΔle® SCH
Rohr SCH
Tube rigide TrΔle® SCH

SCH BUTT WELD fittings | **144**

Racores SCH - BUTT WELD
SCH - BW Armaturen
Raccords SCH - BUTT WELD

SOCKET WELD fittings | **146**

Racores SOCKET WELD
SOCKET WELD
Raccords SOCKET WELD

SAE Flanges | **148**

Bridas SAE
SAE-Flansche
Brides SAE

TrΔle®Clamps | **155**

Abrazaderas TrΔle®
Schellen
Colliers TrΔle®



03

SCH TRALE® RIGID PIPE/ SCH FITTINGS / SAE FLANGES / CLAMPS

Tubo rígido TrΔle® SCH / Racores SCH / Bidas SAE / Abrazaderas

Rohr SCH / SCH Armaturen/SAE-Flansche/ Schellen

Tube rigide SCH TrΔle®/ Embouts SCH/ Bidas SAE / Colliers

SCH TrΔle® Rigid pipe

Tubo TrΔle® SCH
Rohr SCH
Tube rigide TrΔle® SCH

Schedule 10 ▪ Tubo SCH10 ▪ Schedule 10 ▪ Schedule 10

| 143



ZTH10

ZTH10...-3

Schedule 40 ▪ Tubo SCH40 ▪ Schedule 40 ▪ Schedule 40

| 143



ZTH40

ZTH40...-3

SCH BUTT WELD fittings

Racores SCH - BUTT WELD

SCH - BW Armaturen

Raccords SCH - BUTT WELD

SCH -BW Pipe Fittings ▪ Racores Tubo SCH - BW ▪ SCH - BW Rohrverbindungsstücke ▪ Raccords SCH - BW

144



ZS9010



ZST100



ZSR100



ZSC100



ZS9040



ZST400



ZSR400



ZSC400

SOCKET WELD fittings

Racores SOCKET WELD
SOCKET WELD
Raccords SOCKET WELD

SOCKET WELD 3000 fittings ▪ Racores SOCKET WELD 3000 ▪ BUCHSENSCHWEISSEN 3000 Armaturen ▪ Raccords
SOCKET WELD 3000

146



ZSW390



ZSW3C



ZSW3T



ZSW3CR



ZSW3M

SOCKET WELD 6000 fittings ▪ Racores SOCKET WELD 6000 ▪ BUCHSENSCHWEISSEN 6000 Armaturen ▪ Raccords
SOCKET WELD 6000

146



ZSW690



ZSW6M

SAE Flanges

Bridas SAE
SAE-Flansche
Brides SAE

SAE Flanges for hoses ▪ Bridas para flexibles ▪ Flansche für Schlauch ▪ Brides SAE pour flexibles

148

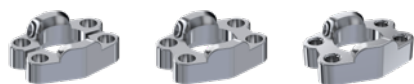

ZBBP

ZBBE

ZBCE

Threaded flanges ▪ Bridas roscadas ▪ Gewindeflansche - GF ▪ Brides taraudées

149



ZBBRG

ZBCRG

ZB90RG

Welding flanges for gas tube ▪ Bridas soldables tubo Gas ▪ Schweißflansche Rohr Gas ▪ Brides à souder pour tube gaz

150



ZBBSG

ZBCSG

ZB90SG

Welding flanges for metric tube ▪ Bridas soldables tubo Métrico ▪ Schweißflansche Rohr metr. ▪ Brides à souder pour tube métrique

151



ZBBSM

ZBCSM

ZB90SM

Blind flanges ▪ Bridas ciegas ▪ Blindflansche ▪ Brides avec obturateur fermé

152



ZBBC

ZBCC

Welding adaptors for flanges ▪ Conos soldar ▪ Schweißkegel ▪ Collets à souder

153



ZBSM*1

ZBSG*1

ZBSM*0

ZBSG*0

ZBSW

Flange accessories ▪ Accesorios bridas ▪ Zubehör für Flansche ▪ Accessoires pour brides

154



ZTB

JBR

ORING

TrAle® Clamps

Abrazaderas TrAle®

Schellen

Colliers TrAle®

Complete clamps light serie ▪ Abrazaderas completas serie ligera ▪ Befestigungsschellen komplett - Leichte Serie ▪ Colliers complets série légère

155



ZA40AZ

ZA40AZPL

ZA41AZ

ZA41AZPL

Components for clamps light serie ▪ Componentes abrazaderas serie ligera ▪ Komponenten für Rohrschellen Leichte Serie ▪ Composants pour colliers série légère

156



A C

ZAPIN

ZAP5

ZAVTC

ZAVTE

ZAVTA

ZAPA

ZAPT

ZAPG

Double clamp - parallel ▪ Dobles / paralelas ▪ Doppel - Parallel ▪ Colliers de fixation doubles

159



ZAZCFS

ZADPIN

ZADPS

AD C

ZADVTE

ZADP

ZADVT

ZADAG

Clamps heavy serie ▪ Abrazaderas serie pesada ▪ Rohrschellen Schwere Serie ▪ Colliers série lourde

161

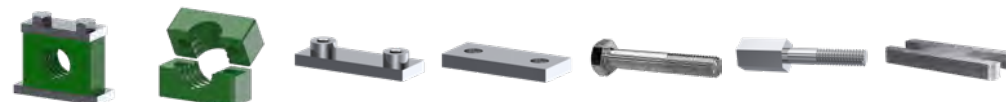

ZAZCPS

AMPP C

ZAPINP

ZAPSP

ZAVTE

ZAPVTA

ZAPA

Accessories for clamps ▪ Accesorios abrazaderas ▪ Zubehör Befestigungsschellen ▪ Accessoires pour colliers

162



TC/TS

SCH TrAde® Rigid pipe

Tubo TrAde® SCH

Rohr SCH

Tube rigide TrAde® SCH

SCH 10 rigid pipe - 6 metres- AISI 316

Tubo rígido SCH10 - AISI 316 - 6 METROS

Rohr - SCH10 - 6 Meter- AISI 316

Tube rigide SCH10 - 6 metres- AISI 316



DN	Ø EXT. Ø OUTER	Espesor (mm) Thickness (mm)	Referencia Part n°	€/M
1/2"	21.3	2.11	ZTH10SC008	33,89
3/4"	26.7	2.11	ZTH10SC012	44,54
1"	33.4	2.77	ZTH10SC016	64,54
1" 1/4	42.2	2.77	ZTH10SC020	79,80
1" 1/2	48.3	2.77	ZTH10SC024	92,68
2"	60.3	2.77	ZTH10SC032	163,41

SCH 10 rigid pipe - 3 metres - AISI 316

Tubo rígido SCH10 - AISI 316 - 3 METROS

Rohr - SCH10 - 3 Meter- AISI 316

Tube rigide SCH10 - 3 metres - AISI 316



DN	Ø EXT. Ø OUTER	Espesor (mm) Thickness (mm)	Referencia Part n°	€/M
1/2"	21.3	2.11	ZTH10SC008-3	35,58
3/4"	26.7	2.11	ZTH10SC012-3	46,77
1"	33.4	2.77	ZTH10SC016-3	67,76
1" 1/4	42.2	2.77	ZTH10SC020-3	83,79
1" 1/2	48.3	2.77	ZTH10SC024-3	97,31
2"	60.3	2.77	ZTH10SC032-3	171,58

SCH 40 rigid pipe - 6 meters - AISI 316

Tubo rígido SCH40 - AISI 316 - 6 METROS

Rohr - SCH40 - 6 Meter- AISI 316

Tube rigide SCH40 - 6 metres - AISI 316



DN	Ø EXT. Ø OUTER	Espesor (mm) Thickness (mm)	Referencia Part n°	€/M
1/2"	21.3	2.77	ZTH40SC008	47,17
3/4"	26.7	2.87	ZTH40SC012	61,76
1"	33.4	3.38	ZTH40SC016	82,48
1" 1/4	42.2	3.56	ZTH40SC020	97,02
1" 1/2	48.3	3.68	ZTH40SC024	123,41
2"	60.3	3.91	ZTH40SC032	187,51

SCH 40 rigid pipe - 3 metres- AISI 316

Tubo rígido SCH40 - AISI 316 - 3 METROS

Rohr - SCH40 - 3 Meter- AISI 316

Tube rigide SCH40 - 3 metres- AISI 316



DN	Ø EXT. Ø OUTER	Espesor (mm) Thickness (mm)	Referencia Part n°	€/M
1/2"	21.3	2.77	ZTH40SC008-3	49,53
3/4"	26.7	2.87	ZTH40SC012-3	64,84
1"	33.4	3.38	ZTH40SC016-3	86,61
1" 1/4	42.2	3.56	ZTH40SC020-3	101,87
1" 1/2	48.3	3.68	ZTH40SC024-3	129,58
2"	60.3	3.91	ZTH40SC032-3	196,89

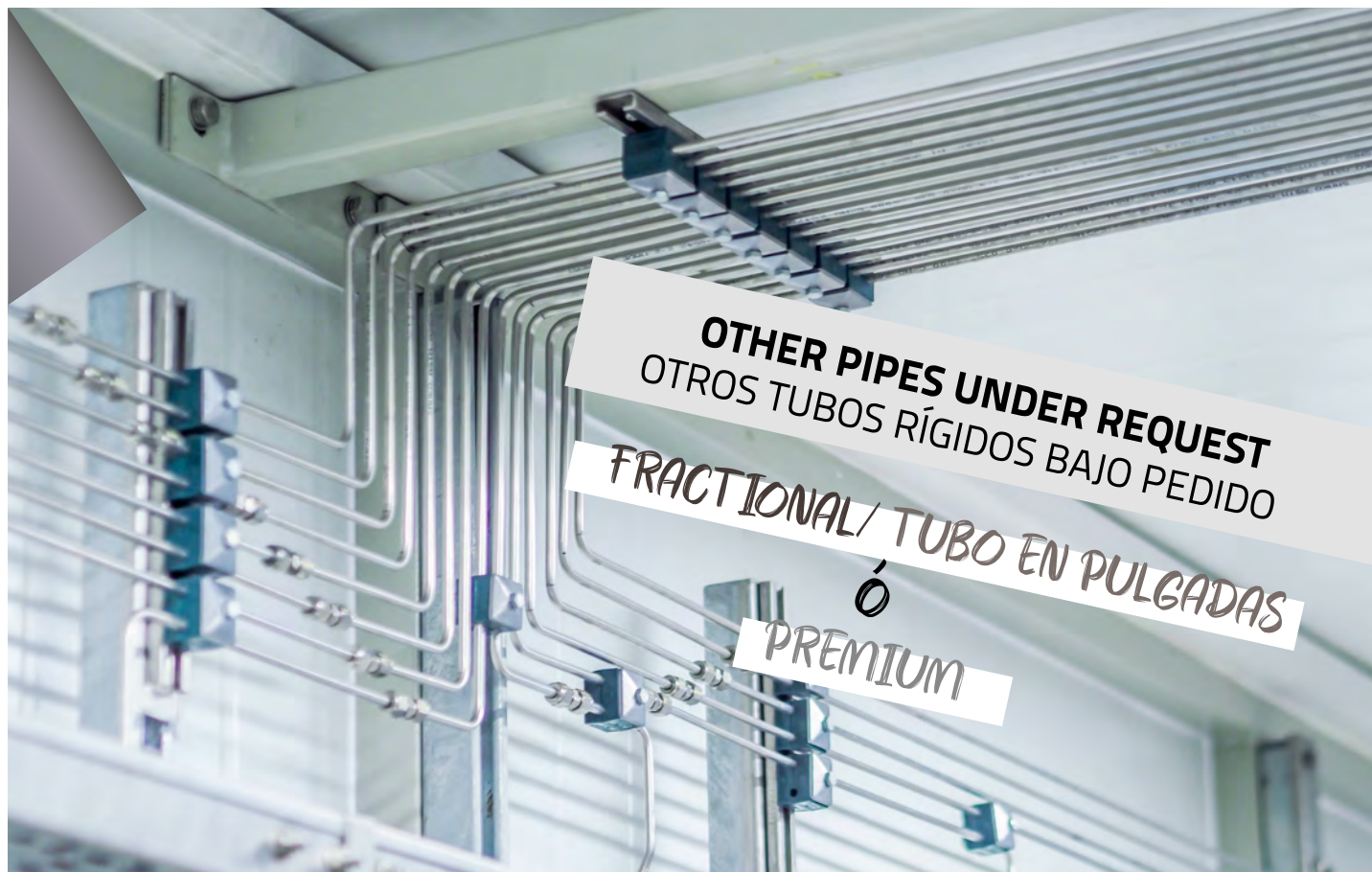

SCH BUTT WELD fittings

Racores SCH - BUTT WELD

SCH - BW Armaturen

Raccords SCH - BUTT WELD

Elbow 90 Sch10

Codo 90 SCH10

Edelstahlbogen 90 Sch10

Coude 90 Sch10



DN	Referencia Part n°	€
1/2"	ZS9010008	6,97
3/4"	ZS9010012	8,88
1"	ZS9010016	9,24
1" 1/4	ZS9010020	15,08
1" 1/2	ZS9010024	18,59
2"	ZS9010032	24,37

Tee Sch10

Te SCH10

Tee Edelstahl Sch10

Té Sch10



DN	Referencia Part n°	€
1/2"	ZST10008	19,79
3/4"	ZST10012	19,19
1"	ZST10016	24,80
1" 1/4	ZST10020	36,38
1" 1/2	ZST10024	42,67
2"	ZST10032	69,26

Reduction Sch10

Reducción SCH10

Reduzierung Sch10 Edelstahl

Réduction Sch10



DN	Referencia Part n°	€
3/4" - 1/2"	ZSR10012008	7,21
1" - 3/4"	ZSR10016012	7,94
1" 1/4 - 1"	ZSR10020016	10,59
1" 1/2 - 1" 1/4	ZSR10024020	11,91
2" - 1" 1/2	ZSR10032024	18,20

Cap Sch10

Tapón SCH10

Verschluss Sch10 Edelstahl

Bouchon Sch 10



DN	Referencia Part n°	€
1/2"	ZSC10008	7,94
3/4"	ZSC10012	9,93
1"	ZSC10016	11,91
1" 1/4	ZSC10020	12,57
1" 1/2	ZSC10024	13,90
2"	ZSC10032	16,54

SCH BUTT WELD fittings

Racores SCH - BUTT WELD

SCH - BW Armaturen

Raccords SCH - BUTT WELD

Elbow 90 Sch40

Codo 90 SCH40

Edelstahlbogen 90 Sch40

Coude 90 Sch40



DN	Referencia Part n°	€
1/2"	ZS9040008	7,74
3/4"	ZS9040012	10,58
1"	ZS9040016	10,84
1" 1/4	ZS9040020	16,20
1" 1/2	ZS9040024	22,46
2"	ZS9040032	42,60

Tee Sch40

Te Inox SCH40

Tee Edelstahl Sch40

Té Sch40



DN	Referencia Part n°	€
1/2"	ZST40008	22,51
3/4"	ZST40012	23,22
1"	ZST40016	31,88
1" 1/4	ZST40020	42,13
1" 1/2	ZST40024	53,58
2"	ZST40032	84,65

Reduccion Sch40

Reducción Inox SCH40

Reduzierung Sch40 Edelstahl

Réduction Sch40



DN	Referencia Part n°	€
3/4" - 1/2"	ZSR40012008	7,94
1" - 3/4"	ZSR40016012	9,59
1" 1/4 - 1"	ZSR40020016	13,56
1" 1/2 - 1" 1/4	ZSR40024020	17,20
2" - 1" 1/2"	ZSR40032024	21,14

Cap Sch40

Tapón Inox SCH40

Verschluss Sch40 Edelstahl

Bouchon Sch40



DN	Referencia Part n°	€
1/2"	ZSC40008	9,59
3/4"	ZSC40012	11,25
1"	ZSC40016	14,89
1" 1/4	ZSC40020	15,55
1" 1/2	ZSC40024	16,54
2"	ZSC40032	18,86

SOCKET WELD fittings

Racores SOCKET WELD

SOCKET WELD

Raccords SOCKET WELD

SOCKET WELD 3000 fittings Elbow 90

Racores SOCKET WELD 3000 Codo 90

BUCHSENSCHWEISSEN 3000 Armaturen Winkel 90

Raccords SOCKET WELD 3000 Coude 90



DN	Referencia Part n°	€
1/2"	ZSW39008	12,75
3/4"	ZSW39012	18,59
1"	ZSW39016	28,66
1" 1/4	ZSW39020	50,34
1" 1/2	ZSW39024	69,70
2"	ZSW39032	110,34

SOCKET WELD 3000 Cap Fittings

Racores SOCKET WELD 3000 Cap

BUCHSENSCHWEISSEN 3000 Kappenanschlüsse

Raccords à chapeau SOCKET WELD 3000



DN	Referencia Part n°	€
1/2"	ZSW3C08	6,97
3/4"	ZSW3C12	12,39
1"	ZSW3C16	15,49
1" 1/4	ZSW3C20	24,78
1" 1/2	ZSW3C24	28,66
2"	ZSW3C32	54,21

SOCKET WELD 3000 Tee fittings

Racores SOCKET WEL 3000 Te

BUCHSENSCHWEISSEN 3000 T-Stücke

Raccords en T SOCKET WELD 3000



DN	Referencia Part n°	€
1/2"	ZSW3T08	21,27
3/4"	ZSW3T12	32,89
1"	ZSW3T16	46,47
1" 1/4	ZSW3T20	65,83
1" 1/2	ZSW3T24	98,72
2"	ZSW3T32	162,64

SOCKET WELD 3000 Cross Fittings

Racores SOCKET WELD 3000 Cruz

BUCHSENSCHWEISSEN 3000 Kreuzstück

Raccords croix SOCKET WELD 3000



DN	Referencia Part n°	€
1/2"	ZSW3CR08	*
3/4"	ZSW3CR12	*
1"	ZSW3CR16	*
1" 1/4	ZSW3CR20	*
1" 1/2	ZSW3CR24	*
2"	ZSW3CR32	*

SOCKET WELD 3000 Couplings Fittings

Racores SOCKET WELD 3000 Manguito

BUCHSENSCHWEISSEN 3000 kupplungen
Armaturen

SOCKET WELD 3000 Accouplements Raccords



DN	Referencia Part n°	€
1/2"	ZSW3M08	6,74
3/4"	ZSW3M12	11,28
1"	ZSW3M16	15,73
1" 1/4	ZSW3M20	24,08
1" 1/2	ZSW3M24	30,48
2"	ZSW3M32	56,16

SOCKET WELD 6000 fittings Elbow 90

Racores SOCKET WELD 6000 Codo 90

BUCHSENSCHWEISSEN 6000 Armaturen Winkel 90

Raccords SOCKET WELD 6000 Coude 90



DN	Referencia Part n°	€
1/2"	ZSW69008	21,69
3/4"	ZSW69012	30,98
1"	ZSW69016	50,34
1" 1/4	ZSW69020	69,70

SOCKET WELD 6000 Couplings Fittings

Racores SOCKET WELD 6000 Manguito

BUCHSENSCHWEISSEN 6000 kupplungen
Armaturen

SOCKET WELD 6000 Accouplements Raccords



DN	Referencia Part n°	€
1/2"	ZSW6M08	13,94
3/4"	ZSW6M12	17,04
1"	ZSW6M16	25,56
1" 1/4	ZSW6M20	28,66

SAE FLANGES

Bridas SAE
SAE-Flansche
Brides SAE

- **Common characteristics**
Características comunes
Allgemeine Eigenschaften
Données communes

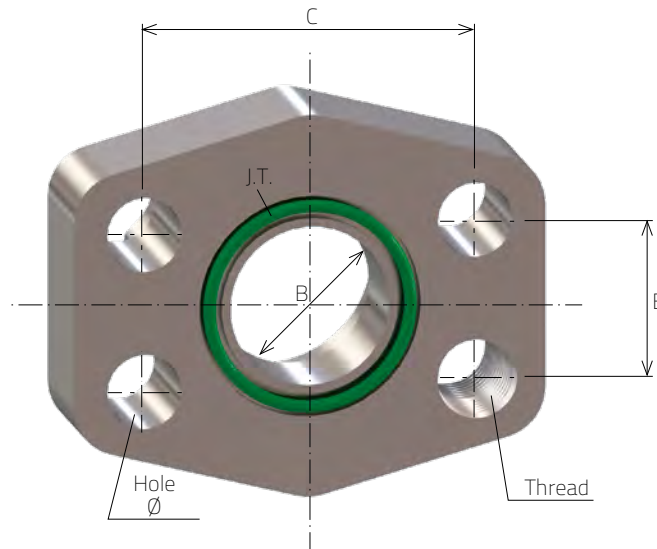

- **Flanges 3000 PSI**
Bridas 3000 PSI
Flansche 3000 PSI
Brides 3000 PSI

Size	Max. pre.	B	C	E	O'ring NBR	PU seal	Ø	Screw *	Thread
1/2"	345 bar	13	38,1	17,48	18,64 x 3,53	JBR08	9	TB8X30	M8
3/4"	345 bar	19	47,63	22,23	24,99 x 3,53	JBR12	11	TB10X35	M10
1"	345 bar	25	52,37	26,19	32,92 x 3,53	JBR16	11	TB10X35	M10
1 1/4"	276 bar	32	58,72	30,18	37,70 x 3,53	JBR20	11,5	TB10X40	M10
1 1/2"	207 bar	38	69,85	35,71	47,22 x 3,53	JBR24	13,5	TB12X45	M12
2"	207 bar	51	77,77	42,88	56,74 x 3,53	JBR32	13,5	TB12X45	M12
2 1/2"	172 bar	63	88,9	50,8	66,27 x 3,53		13,5	TB12X45	M12
3"	138 bar	73	106,38	61,93	85,32 x 3,53		17,5	TB16X50	M16
3 1/2"	34 bar	89	120,65	69,85	98,02 x 3,53		17,5	TB16X50	M16
4"	34 bar	99	130,18	77,77	110,72 x 3,53		17,5	TB16X50	M16

- **Flanges 6000 PSI**
Bridas 6000 PSI
Flansche 6000 PSI
Brides 6000 PSI

Size	Max. pre.	B	C	E	O'ring NBR	PU seal	Ø	Screw *	Thread
1/2"	414 bar	13	40,49	18,24	18,64 x 3,53	JBR08	9	TB8X30	M8
3/4"	414 bar	19	50,8	23,8	24,99 x 3,53	JBR12	11	TB10X40	M10
1"	414 bar	25	57,15	27,76	32,92 x 3,53	JBR16	13	TB12X45	M12
1 1/4"	414 bar	32	66,68	31,75	37,70 x 3,53	JBR20	15	TB14X45	M14
1 1/2"	414 bar	38	79,38	36,5	47,22 x 3,53	JBR24	17	TB16X50	M16
2"	414 bar	51	98,82	44,45	56,74 x 3,53	JBR32	21	TB20X70	M20

- * **Screws are in carbon steel. For Stainless Steel screws, ask for ZTB... part number.**
Tornillos en acero carbono. Para tornillos en acero inoxidable, pedir ZTB...
Die Schrauben sind aus Karbonstahl. Für Edelstahl fragen Sie bitten nach ZTB... Artikelnummern.
Les vis sont en acier carbone. Pour vis en acier inoxydable, veuillez demander les références ZTB ...

SAE Flanges

Bridas SAE
SAE-Flansche
Brides SAE

SAE Split flange

Brida partida pasante

Durchgehender Halbflansch

Demi-bride passage total



SAE counter-flange

Contrabrida roscada

Gewindegegenflansch

Contre-bride passage total



SERIE SERIES	Ø INT. Ø INNER	TAMAÑO SIZE	Referencia Part n°	€
3000 PSI	30.2	1/2"	ZBBP308302	*
3000 PSI	38.1	3/4"	ZBBP312381	*
3000 PSI	44.5	1"	ZBBP316445	*
3000 PSI	50.8	1"1/4	ZBBP320508	*
3000 PSI	60.3	1"1/2	ZBBP324603	*
3000 PSI	71.4	2"	ZBBP332714	*
3000 PSI	84.1	2" 1/2	ZBBP340841	*
3000 PSI	102.4	3"	ZBBP3481024	*
3000 PSI	127	4"	ZBBP364127	*
6000 PSI	31.8	1/2"	ZBBP608318	*
6000 PSI	41.3	3/4"	ZBBP612413	*
6000 PSI	47.6	1"	ZBBP616476	*
6000 PSI	54	1"1/4	ZBBP620540	*
6000 PSI	63.5	1"1/2	ZBBP624635	*
6000 PSI	79.4	2"	ZBBP632794	*

SERIE SERIES	Ø INT. Ø INNER	TAMAÑO SIZE	Referencia Part n°	€
3000 PSI	30,2	1/2"	ZBCE308302	*
3000 PSI	38,1	3/4"	ZBCE312381	*
3000 PSI	44,5	1"	ZBCE316445	*
3000 PSI	50,8	1"1/4	ZBCE320508	*
3000 PSI	60,3	1"1/2	ZBCE324603	*
3000 PSI	71,4	2"	ZBCE332714	*
6000 PSI	31,8	1/2"	ZBCE608318	*
6000 PSI	41,3	3/4"	ZBCE612413	*
6000 PSI	47,6	1"	ZBCE616476	*
6000 PSI	54	1"1/4	ZBCE620540	*
6000 PSI	63,5	1"1/2	ZBCE624635	*
6000 PSI	79,4	2"	ZBCE632794	*

*See prices in p.40 (FITTINGS) / *Ver precios en p. 40 (CONEXIONES) / *Vgl. Sie die Preise auf S. 40 (ARMATUREN) / *Prix à la p.40 (EMBOUTS)

SAE Flange

Brida entera pasante

Durchgehender Vollflansch

Bride monobloc passage total



SERIE SERIES	Ø INT. Ø INNER	TAMAÑO SIZE	Referencia Part n°	€
3000 PSI	30.2	1/2"	ZBBE308302	*
3000 PSI	38.1	3/4"	ZBBE312381	*
3000 PSI	44.5	1"	ZBBE316445	*
3000 PSI	50.8	1"1/4	ZBBE320508	*
3000 PSI	60.3	1"1/2	ZBBE324603	*
3000 PSI	71.4	2"	ZBBE332714	*
3000 PSI	41	2" 1/2	ZBBE340841	*
3000 PSI	102.4	3"	ZBBE3481024	*
3000 PSI	127	4"	ZBBE364127	*
6000 PSI	31.8	1/2"	ZBBE608318	*
6000 PSI	41.3	3/4"	ZBBE612413	*
6000 PSI	47.6	1"	ZBBE616476	*
6000 PSI	54	1"1/4	ZBBE620540	*
6000 PSI	63.5	1"1/2	ZBBE624635	*
6000 PSI	79.4	2"	ZBBE632794	*

*See prices in p.40 (FITTINGS) / *Ver precios en p. 40 (CONEXIONES) / *Vgl. Sie die Preise auf S. 40 (ARMATUREN) / *Prix à la p.40 (EMBOUTS)

SAE Flanges

Bridas SAE
SAE-Flansche
Brides SAE

BSP Female threaded flange

Brida roscada hembra BSP

Gewindeflansch w BSP

Bride taraudée femelle BSP



SERIE SERIES	ROSCA THREAD	TAMAÑO SIZE	Referencia Part n°	€
3000 PSI	1/2" BSP	1/2"	ZBBRG30808	28,61
3000 PSI	3/4" BSP	3/4"	ZBBRG31212	37,47
3000 PSI	1" BSP	1"	ZBBRG31616	46,79
3000 PSI	1"1/4 BSP	1"1/4	ZBBRG32020	59,20
3000 PSI	1"1/2 BSP	1"1/2	ZBBRG32424	90,26
3000 PSI	2" BSP	2"	ZBBRG33232	117,35
3000 PSI	2"1/2 BSP	2"1/2	ZBBRG34040	165,49
3000 PSI	3" BSP	3"	ZBBRG34848	204,56
3000 PSI	3"1/2 BSP	3"1/2	ZBBRG35656	820,26
3000 PSI	4" BSP	4"	ZBBRG36464	886,78
6000 PSI	1/2" BSP	1/2"	ZBBRG60808	31,22
6000 PSI	3/4" BSP	3/4"	ZBBRG61212	43,63
6000 PSI	1" BSP	1"	ZBBRG61616	62,36
6000 PSI	1"1/4 BSP	1"1/4	ZBBRG62020	84,18
6000 PSI	1"1/2 BSP	1"1/2	ZBBRG62424	119,20
6000 PSI	2" BSP	2"	ZBBRG63232	213,49

BSP Female threaded counter-flange

Contrabrida roscada hembra BSP

Gewindegegenflansch w BSP

Contre-bride taraudée femelle BSP



SERIE SERIES	ROSCA THREAD	TAMAÑO SIZE	Referencia Part n°	€
3000 PSI	1/2" BSP	1/2"	ZBCRG30808	29,64
3000 PSI	3/4" BSP	3/4"	ZBCRG31212	37,47
3000 PSI	1" BSP	1"	ZBCRG31616	46,79
3000 PSI	1"1/4 BSP	1"1/4	ZBCRG32020	59,20
3000 PSI	1"1/2 BSP	1"1/2	ZBCRG32424	93,51
3000 PSI	2" BSP	2"	ZBCRG33232	117,35
3000 PSI	2"1/2 BSP	2"1/2	ZBCRG34040	165,49
3000 PSI	3" BSP	3"	ZBCRG34848	211,91
3000 PSI	3"1/2 BSP	3"1/2	ZBCRG35656	820,26
3000 PSI	4" BSP	4"	ZBCRG36464	886,78
6000 PSI	1/2" BSP	1/2"	ZBCRG60808	31,22
6000 PSI	3/4" BSP	3/4"	ZBCRG61212	43,63
6000 PSI	1" BSP	1"	ZBCRG61616	62,36
6000 PSI	1"1/4 BSP	1"1/4	ZBCRG62020	84,18
6000 PSI	1"1/2 BSP	1"1/2	ZBCRG62424	119,20
6000 PSI	2" BSP	2"	ZBCRG63232	213,49

90° BSP female threaded flange

Brida codo 90° roscada hembra BSP

Gewindeflansch Winkel 90° w BSP

Bride 90° taraudée femelle BSP



SERIE SERIES	ROSCA THREAD	TAMAÑO SIZE	Referencia Part n°	€
3000 PSI	1/2" BSP	1/2"	ZB90RG30808	161,36
3000 PSI	3/4" BSP	3/4"	ZB90RG31212	193,24
3000 PSI	1" BSP	1"	ZB90RG31616	230,70
3000 PSI	1"1/4 BSP	1"1/4	ZB90RG32020	276,91
3000 PSI	1"1/2 BSP	1"1/2	ZB90RG32424	539,12
3000 PSI	2" BSP	2"	ZB90RG33232	729,34
6000 PSI	1/2" BSP	1/2"	ZB90RG60808	161,36
6000 PSI	3/4" BSP	3/4"	ZB90RG61212	230,70
6000 PSI	1" BSP	1"	ZB90RG61616	319,51
6000 PSI	1"1/4 BSP	1"1/4	ZB90RG62020	378,52
6000 PSI	1"1/2 BSP	1"1/2	ZB90RG62424	498,08

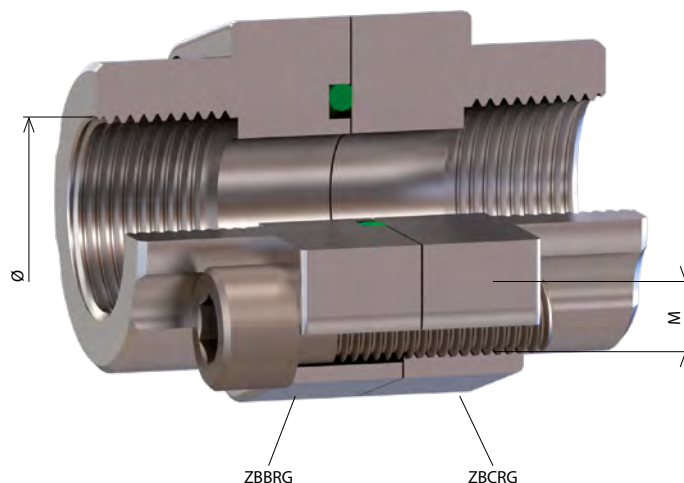

SAE Flanges

Bridas SAE
SAE-Flansche
Brides SAE

Welding female flange for gas tube

Brida soldable hembra tubo gas

Schweißflansch w Rohr Gas

Bride à souder femelle tube gaz



SERIE SERIES	Ø INT. Ø INNER	TAMAÑO SIZE	Referencia Part n°	€
3000 PSI	21.6	1/2"	ZBBSG308216	29,64
3000 PSI	27.2	3/4"	ZBBSG312272	37,47
3000 PSI	34.0	1"	ZBBSG316340	46,79
3000 PSI	42.8	1 1/4"	ZBBSG320428	59,20
3000 PSI	48.6	1 1/2"	ZBBSG324486	93,51
3000 PSI	61.0	2"	ZBBSG332610	121,57
3000 PSI	76.6	2 1/2"	ZBBSG340766	171,44
3000 PSI	90.5	3"	ZBBSG348905	211,91
3000 PSI	103.0	3 1/2"	ZBBSG3561030	775,89
3000 PSI	115.5	4"	ZBBSG3641155	842,41
6000 PSI	21.6	1/2"	ZBBSG608216	31,22
6000 PSI	27.2	3/4"	ZBBSG612272	43,63
6000 PSI	34.0	1"	ZBBSG616340	62,36
6000 PSI	42.8	1 1/4"	ZBBSG620428	84,18
6000 PSI	48.6	1 1/2"	ZBBSG624486	119,20
6000 PSI	61.0	2"	ZBBSG632610	213,49

Welding female counter-flange for gas tube

Contrabrida soldable hembra tubo gas

Schweiß-Gegenflansch w Rohr Gas

Contre-bride à souder femelle tube gaz



SERIE SERIES	Ø INT. Ø INNER	TAMAÑO SIZE	Referencia Part n°	€
3000 PSI	21.6	1/2"	ZBCSG308216	29,64
3000 PSI	27.2	3/4"	ZBCSG312272	37,47
3000 PSI	34.0	1"	ZBCSG316340	46,79
3000 PSI	42.8	1 1/4"	ZBCSG320428	59,20
3000 PSI	48.6	1 1/2"	ZBCSG324486	93,51
3000 PSI	61.0	2"	ZBCSG332610	121,57
3000 PSI	76.6	2 1/2"	ZBCSG340766	171,44
3000 PSI	90.5	3"	ZBCSG348905	211,91
3000 PSI	103.0	3 1/2"	ZBCSG3561030	775,89
3000 PSI	115.5	4"	ZBCSG3641155	842,41
6000 PSI	21.6	1/2"	ZBCSG608216	31,22
6000 PSI	27.2	3/4"	ZBCSG612272	43,63
6000 PSI	34.0	1"	ZBCSG616340	62,36
6000 PSI	42.8	1 1/4"	ZBCSG620428	84,18
6000 PSI	48.6	1 1/2"	ZBCSG624486	119,20
6000 PSI	61.0	2"	ZBCSG632610	213,49

90° welding female flange for gas tube

Brida codo 90° soldable hembra tubo gas

Vorschweißflansch Winkel 90° w Rohr Gas

Bride 90° à souder femelle tube gaz



SERIE SERIES	Ø INT. Ø INNER	TAMAÑO SIZE	Referencia Part n°	€
3000 PSI	21.6	1/2"	ZB90SG308216	177,44
3000 PSI	27.2	3/4"	ZB90SG312272	187,26
3000 PSI	34.0	1"	ZB90SG316340	223,93
3000 PSI	42.8	1 1/4"	ZB90SG320428	269,35
3000 PSI	48.6	1 1/2"	ZB90SG324486	370,96
3000 PSI	61.0	2"	ZB90SG332610	719,36
6000 PSI	21.6	1/2"	ZB90SG608216	247,06
6000 PSI	27.2	3/4"	ZB90SG612272	244,34
6000 PSI	34.0	1"	ZB90SG616340	269,35
6000 PSI	42.8	1 1/4"	ZB90SG620428	370,96
6000 PSI	48.6	1 1/2"	ZB90SG624486	488,09

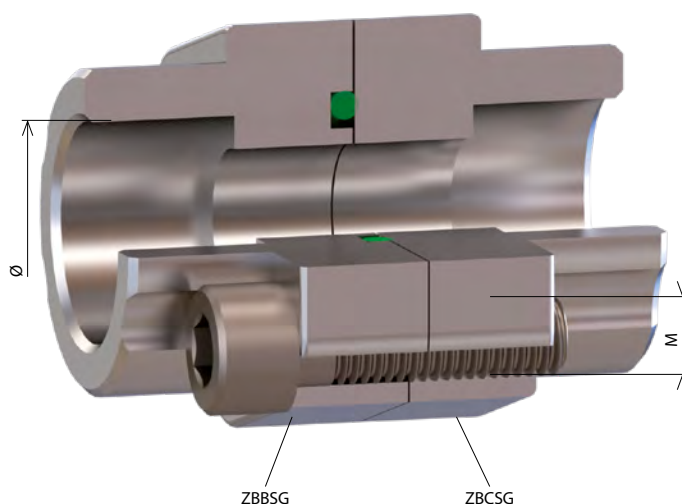

SAE Flanges

Bridas SAE
SAE-Flansche
Brides SAE

Female welding flange for metric tube

Brida soldable hembra tubo métrico

Schweißflansch w Rohr metr.

Bride à souder femelle tube métrique



SERIE SERIES	Ø INT. Ø INNER	TAMAÑO SIZE	Referencia Part n°	€
3000 PSI	20.3	1/2"	ZBBSM308203	29,64
3000 PSI	25.3	3/4"	ZBBSM312253	37,47
3000 PSI	30.3	1"	ZBBSM316303	46,79
3000 PSI	38.3	1"1/4	ZBBSM320383	59,20
3000 PSI	50.5	1"1/2	ZBBSM324505	93,51
6000 PSI	20.3	1/2"	ZBBSM608203	31,22
6000 PSI	25.3	3/4"	ZBBSM612253	43,63
6000 PSI	30.3	1"	ZBBSM616303	62,36
6000 PSI	38.3	1"1/4	ZBBSM620383	84,18
6000 PSI	50.5	1"1/2	ZBBSM624505	119,20

Female welding counter-flange for metric tube

Contrabrida soldable hembra tubo métrico

Schweiß-Gegenflansch w Rohr metr.

Contre-bride à souder femelle tube métrique



SERIE SERIES	Ø INT. Ø INNER	TAMAÑO SIZE	Referencia Part n°	€
3000 PSI	20.3	1/2"	ZBCSM308203	29,64
3000 PSI	25.3	3/4"	ZBCSM312253	37,47
3000 PSI	30.3	1"	ZBCSM316303	46,79
3000 PSI	38.3	1"1/4	ZBCSM320383	59,20
3000 PSI	50.5	1"1/2	ZBCSM324505	93,51
6000 PSI	20.3	1/2"	ZBCSM608203	31,22
6000 PSI	25.3	3/4"	ZBCSM612253	43,63
6000 PSI	30.3	1"	ZBCSM616303	62,36
6000 PSI	38.3	1"1/4	ZBCSM620383	84,18
6000 PSI	50.5	1"1/2	ZBCSM624505	119,20

90° female welding flange for metric tube

Brida codo 90° soldable Hembra tubo métrico

Vorschweißflansch Winkel 90° w Rohr metr.

Bride 90° à souder femelle tube métrique



SERIE SERIES	Ø INT. Ø INNER	TAMAÑO SIZE	Referencia Part n°	€
3000 PSI	20.3	1/2"	ZB90SM308203	177,44
3000 PSI	25.3	3/4"	ZB90SM312253	164,50
3000 PSI	30.3	1"	ZB90SM316303	196,71
3000 PSI	38.3	1"1/4	ZB90SM320383	236,61
3000 PSI	50.5	1"1/2	ZB90SM324505	325,88
6000 PSI	20.3	1/2"	ZB90SM608203	170,62
6000 PSI	25.3	3/4"	ZB90SM612253	196,71
6000 PSI	30.3	1"	ZB90SM616303	285,93
6000 PSI	38.3	1"1/4	ZB90SM620383	325,88
6000 PSI	50.5	1"1/2	ZB90SM624505	631,93

MALE WELDING FLANGES

Bridas soldables macho
Schweißflansche männlich
Brides à souder mâle

- Male welding flange for gas tube
Brida soldable macho tubo gas
Schweißflansch männlich Rohr Gas
Bride à souder mâle tube gaz

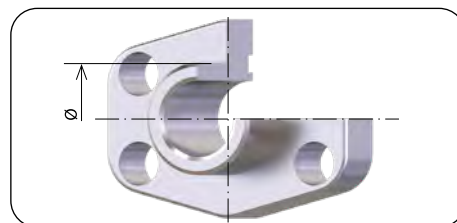

Ref: ZBMSG

- Male welding counterflange for gas tube
Contrabrida macho soldable tubo gas
Gegenschweißflansch männlich Rohr Gas
Contre-bride à souder mâle tube gaz

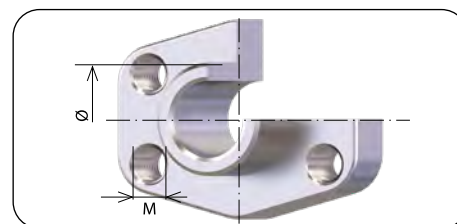

Ref: ZBCMSG

- Male welding flange for metric tube
Brida soldable macho tubo métrico
Metrischer Schweißflansch männlich Rohr
Bride à souder mâle tube métrique

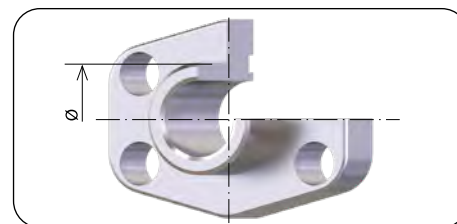

Ref: ZBMSM

- Male welding counterflange for metric tube
Contrabrida macho soldable tubo métrico
Metrischer Gegenschweißflansch männlich Rohr
Contre-bride à souder mâle tube métrique

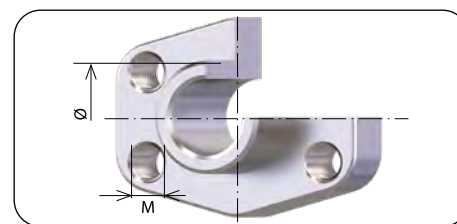

Ref: ZBCMSM

SAE Flanges

Bridas SAE
SAE-Flansche
Brides SAE

Blind flanges

Bridas ciegas

Blindflansche

Brides avec obturateur fermé



Blind counter-flanges

Contrabridas ciegas

Blind-/Gegenflansche

Contre-brides avec obturateur fermé



SERIE SERIES	TAMAÑO SIZE	Referencia Part n°	€
3000 PSI	1/2"	ZBBC308	105,58
3000 PSI	3/4"	ZBBC312	129,20
3000 PSI	1"	ZBBC316	151,89
3000 PSI	1 1/4"	ZBBC320	177,25
3000 PSI	1 1/2"	ZBBC324	227,86
3000 PSI	2"	ZBBC332	263,31
3000 PSI	2 1/2"	ZBBC340	303,82
3000 PSI	3"	ZBBC348	430,40
3000 PSI	3 1/2"	ZBBC356	557,00
3000 PSI	4"	ZBBC364	658,21
6000 PSI	1/2"	ZBBC608	113,08
6000 PSI	3/4"	ZBBC612	151,89
6000 PSI	1"	ZBBC616	192,44
6000 PSI	1 1/4"	ZBBC620	273,45
6000 PSI	1 1/2"	ZBBC624	376,87
6000 PSI	2"	ZBBC632	554,22

SERIE SERIES	TAMAÑO SIZE	Referencia Part n°	€
3000 PSI	1/2"	ZBCC308	111,14
3000 PSI	3/4"	ZBCC312	136,02
3000 PSI	1"	ZBCC316	167,07
3000 PSI	1 1/4"	ZBCC320	194,91
3000 PSI	1 1/2"	ZBCC324	250,64
3000 PSI	2"	ZBCC332	289,62
3000 PSI	3"	ZBCC348	473,44
3000 PSI	3 1/2"	ZBCC356	612,71
3000 PSI	4"	ZBCC364	724,05
6000 PSI	1/2"	ZBCC608	137,31
6000 PSI	3/4"	ZBCC612	167,07
6000 PSI	1"	ZBCC616	211,66
6000 PSI	1 1/4"	ZBCC620	263,37
6000 PSI	1 1/2"	ZBCC624	473,44
6000 PSI	2"	ZBCC632	696,22

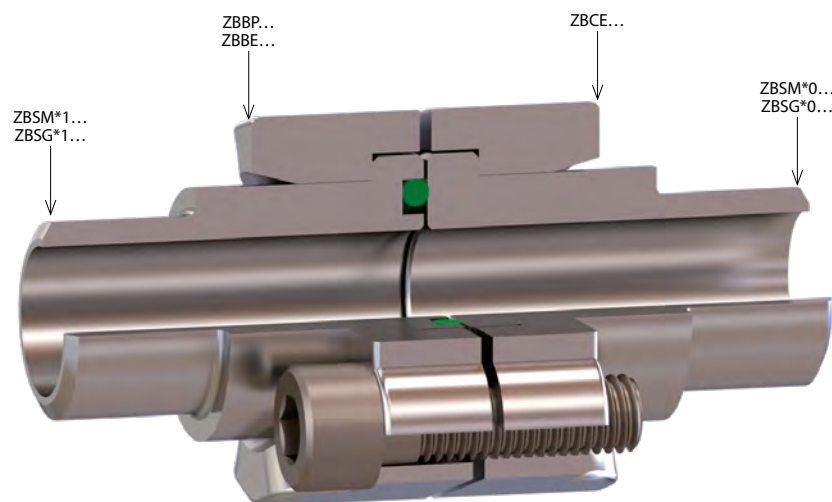

SAE Flanges

Bridas SAE
SAE-Flansche
Brides SAE

Flange welding adaptor for metric tube

Brida cono soldable tubo métrico

Vorschweißflansch kon. Rohr metr.

Bride collet à souder tube métrique



SERIE SERIES	Ø EXT. Ø OUTER	TAMAÑO SIZE	Referencia Part n°	€
3000 PSI	16	1/2"	ZBSM3108016	26,35
3000 PSI	25	3/4"	ZBSM3112025	28,18
3000 PSI	30	1"	ZBSM3116030	42,80
3000 PSI	38	1"1/4	ZBSM3120038	64,99
3000 PSI	45	1"1/2	ZBSM3124045	84,01
3000 PSI	60	2"	ZBSM3132060	155,93
3000 PSI	70	2"1/2	ZBSM3140070	157,41
3000 PSI	80	3"	ZBSM3148080	235,46
3000 PSI	100	3"1/2	ZBSM3156100	985,28
3000 PSI	114.3	4"	ZBSM3164114	1.064,11
6000 PSI	16	1/2"	ZBSM6108016	98,55
6000 PSI	25	3/4"	ZBSM6112025	27,75
6000 PSI	30	1"	ZBSM6116030	34,14
6000 PSI	38	1"1/4	ZBSM6120038	174,40
6000 PSI	45	1"1/2	ZBSM6124045	270,93
6000 PSI	60	2"	ZBSM6132060	325,13

Flange welding adaptor for gas tube

Brida cono soldable tubo gas

Vorschweißflansch kon. Rohr Gas

Bride collet à souder tube gaz



SERIE SERIES	Ø INT. Ø INNER	TAMAÑO SIZE	Referencia Part n°	€
3000 PSI	21.5	1/2"	ZBSG3108215	90,83
3000 PSI	28.0	3/4"	ZBSG3112280	37,29
3000 PSI	34.0	1"	ZBSG3116340	44,60
3000 PSI	42.8	1"1/4	ZBSG3120428	56,75
3000 PSI	48.6	1"1/2	ZBSG3124486	110,00
3000 PSI	61.0	2"	ZBSG3132610	125,61
6000 PSI	21.5	1/2"	ZBSG6108215	19,18
6000 PSI	28.0	3/4"	ZBSG6112280	32,85
6000 PSI	34.0	1"	ZBSG6116340	35,76
6000 PSI	42.8	1"1/4	ZBSG6120428	50,63
6000 PSI	48.6	1"1/2	ZBSG6124486	68,30
6000 PSI	61.0	2"	ZBSG6132610	139,72

Counter-flange welding adaptor for metric tube

Contrabrida cono soldable tubo métrico

Schweiß-Gegenflansch kon. Rohr metr.

Contre-bride collet à souder tube métrique



SERIE SERIES	Ø EXT. Ø OUTER	TAMAÑO SIZE	Referencia Part n°	€
3000 PSI	16	1/2"	ZBSM3008016	29,58
3000 PSI	25	3/4"	ZBSM3012025	28,61
3000 PSI	30	1"	ZBSM3016030	35,06
3000 PSI	38	1"1/4	ZBSM3020038	60,67
3000 PSI	45	1"1/2	ZBSM3024045	92,11
3000 PSI	60	2"	ZBSM3032060	118,39
3000 PSI	70	2"1/2	ZBSM3040070	170,24
3000 PSI	80	3"	ZBSM3048080	238,90
3000 PSI	100	3"1/2	ZBSM3056100	908,11
6000 PSI	16	1/2"	ZBSM6008016	90,83
6000 PSI	25	3/4"	ZBSM6012025	25,80
6000 PSI	30	1"	ZBSM6016030	33,37
6000 PSI	38	1"1/4	ZBSM6020038	174,40
6000 PSI	45	1"1/2	ZBSM6024045	249,72
6000 PSI	60	2"	ZBSM6032060	299,65

Counter-flange welding adaptor for gas tube

Contrabrida cono soldable tubo gas

Schweiß-Gegenflansch kon. Rohr Gas

Contre-bride collet à souder tube gaz



SERIE SERIES	Ø INT. Ø INNER	TAMAÑO SIZE	Referencia Part n°	€
3000 PSI	21.5	1/2"	ZBSG3008215	109,05
3000 PSI	28.0	3/4"	ZBSG3012280	32,44
3000 PSI	34.0	1"	ZBSG3016340	38,65
3000 PSI	42.8	1"1/4	ZBSG3020428	65,37
3000 PSI	48.6	1"1/2	ZBSG3024486	84,71
3000 PSI	61.0	2"	ZBSG3032610	139,42
6000 PSI	21.5	1/2"	ZBSG6008215	19,84
6000 PSI	28.0	3/4"	ZBSG6012280	29,06
6000 PSI	34.0	1"	ZBSG6016340	37,88
6000 PSI	42.8	1"1/4	ZBSG6020428	50,70
6000 PSI	48.6	1"1/2	ZBSG6024486	72,23
6000 PSI	61.0	2"	ZBSG6032610	133,96

Welding flange head SW metric tube

Cabeza brida soldable SW tubo métrico

Schweißflanschkopf SW metrisches Rohr

Tête de bride de soudage SW tube métrique



SERIE SERIES	TUBO PIPE	TAMAÑO SIZE	Referencia Part n°	€
3000 PSI	14	1/2"	ZBSWM3108014	14,42
3000 PSI	22	3/4"	ZBSWM3112022	22,23
3000 PSI	50	2"	ZBSWM3132050	71,40
6000 PSI	22	3/4"	ZBSWM6112022	24,46
6000 PSI	28	1"	ZBSWM6116028	42,72
6000 PSI	35	1"1/4	ZBSWM6120035	48,64
6000 PSI	39	1"1/2	ZBSWM6124039	55,46

Until end of stock / Hasta fin de existencias / Bis zum Ende des Lagerbestandes / Jusqu'à la fin du stock

SAE Flanges

Bridas SAE
SAE-Flansche
Brides SAE

Screws for SAE flanges

Tornillos para bridas SAE

Schrauben für SAE-Flansche

Vis pour brides SAE



ROSCA THREAD	TAMAÑO SIZE	Referencia Part n°	€
M8X30	3000-6000 PSI 1/2"	ZTB8X30	1,43
M10X35	3000 PSI 3/4"-1"	ZTB10X35	2,30
M10X40	3000 PSI 1" 1/4 - 6000 PSI 3/4"	ZTB10X40	2,05
M12X45	3000 PSI 1"1/2-2"-2"1/2-6000 PSI 1"	ZTB12X45	3,84
M14X45	6000 PSI 1"1/4	ZTB14X45	6,52
M16X50	3000 PSI 3"-3"1/2"-4"- 6000 PSI 1" 1/2	ZTB16X50	10,05
M20X70	6000 PSI 2"	ZTB20X70	22,16

Seals for 3000/6000 PSI flange

Juntas para bridas SAE 3000/6000 PSI

Dichtungen 3000/6000 PSI-Flansch

Joints pour bride série 3000/6000



TAMAÑO SIZE	Ø INT. Ø INNER	Ø EXT. Ø OUTER	Referencia Part n°	€
1/2"	17.02	25.40	JBR08	*
3/4"	23.36	31.72	JBR12	*
1"	31.24	39.62	JBR16	*
1"1/4	36.07	44.45	JBR20	*
1"1/2	45.34	53.98	JBR24	*
2"	54.86	63.50	JBR32	*

*See prices in Hydraulic and Pneumatic Connectors' Catalogue / *Ver precios en Conducciones Hidráulicas y Neumáticas / *Vgl. Sie die Preise in der Preisliste Hydraulische und Pneumatische Verbindungen. / *Voir prix dans le Catalogue Connectique Hydraulique et Pneumatique

O-rings for 3000/6000 PSI flange

Juntas tóricas para bridas SAE 3000/6000 PSI

O-Ringe für 3000/6000 PSI-Flansch

O-rings pour bride série 3000/6000 PSI



TAMAÑO SIZE	Ø INT. Ø INNER	Referencia Part n°	€
1/2"	18.64	18.64X3.53	*
3/4"	24.99	24.99X3.53	*
1"	32.92	32.92X3.53	*
1"1/4	37.70	37.70X3.53	*
1"1/2	47.22	47.22X3.53	*
2"	56.74	56.74X3.53	*

*See prices in Hydraulic and Pneumatic Connectors' Catalogue / *Ver precios en Conducciones Hidráulicas y Neumáticas / *Vgl. Sie die Preise in der Preisliste Hydraulische und Pneumatische Verbindungen. / *Voir prix dans le Catalogue Connectique Hydraulique et Pneumatique

TrAle® Clamps

Abrazaderas TrAle®

Schellen

Colliers TrAle®

Light serie simple clamp

Abrazadera ligera simple completa

Einfache Befestigungsschelle komplett - Leichte Serie

Collier de fixation simple complet, série légère



DN	GRUPO GROUP	Referencia Part n°	€
6	1	ZA40AZ06	12,10
8	1	ZA40AZ08	12,10
10	1	ZA40AZ10	12,10
12	1	ZA40AZ12	12,10
14	2	ZA40AZ14	12,80
15	2	ZA40AZ15	12,80
16	2	ZA40AZ16	12,76
18	2	ZA40AZ18	12,76
20	3	ZA40AZ20	13,66
22	3	ZA40AZ22	13,66
23	3	ZA40AZ23	13,66
25	3	ZA40AZ25	13,66
28	4	ZA40AZ28	15,07
30	4	ZA40AZ30	15,07
38	5	ZA40AZ38	17,40
40	5	ZA40AZ40	17,40
42-1" 1/4	5	ZA40AZ42	17,40

Light serie simple clamp, plastic smooth profile

Abrazadera ligera simple completa, plásticos perfil liso

Einfache Befestigungsschelle komplett - Leichte Serie einfach, Plastikteile glatt

Collier de fixation simple série légère, complet, plastic profil lisse



DN	GRUPO GROUP	Referencia Part n°	€
8	1	ZA40AZ08PL	12,10
10	1	ZA40AZ10PL	12,10
12	1	ZA40AZ12PL	12,10
1 1/4"	2	ZA40AZ13.2PL	13,29
15	2	ZA40AZ15PL	13,29
3/8"	2	ZA40AZ16.7PL	13,29
18	2	ZA40AZ18PL	13,29
20	3	ZA40AZ20PL	13,66
1/2"	3	ZA40AZ21.3PL	13,66
22	3	ZA40AZ22PL	13,66
25	3	ZA40AZ25PL	13,66
3/4"	4	ZA40AZ26.7PL	16,20
28	4	ZA40AZ28PL	16,20
30	4	ZA40AZ30PL	16,20
1"	5	ZA40AZ33.3PL	17,94
35	5	ZA40AZ35PL	17,94
38	5	ZA40AZ38PL	18,70
42-1" 1/4	5	ZA40AZ42PL	18,70

Light serie reinforced clamp

Abrazadera ligera reforzada completa

Befestigungsschelle komplett - Leichte Serie verstärkt

Collier de fixation simple série légère renforcé complet



DN	GRUPO GROUP	Referencia Part n°	€
6	1	ZA41AZ06	15,37
8	1	ZA41AZ08	15,37
10	1	ZA41AZ10	15,37
12	1	ZA41AZ12	15,37
1 1/4"	2	ZA41AZ13.2	16,42
14	2	ZA41AZ14	16,42
15	2	ZA41AZ15	16,42
16	2	ZA41AZ16	16,42
18	2	ZA41AZ18	16,42
20	3	ZA41AZ20	18,23
22	3	ZA41AZ22	18,23
23	3	ZA41AZ23	18,23
25	3	ZA41AZ25	18,23
28	4	ZA41AZ28	19,17
30	4	ZA41AZ30	19,17
38	5	ZA41AZ38	22,66
40	5	ZA41AZ40	22,66
42-1" 1/4	5	ZA41AZ42	22,66

Light serie reinforced clamp, plastic smooth profile

Abrazadera ligera reforzada completa, plásticos perfil liso

Befestigungsschelle komplett - Leichte Serie verstärkt, Plastikteile glatt

Collier de fixation simple série légère renforcé, complet, plastic profil lisse



DN	GRUPO GROUP	Referencia Part n°	€
8	1	ZA41AZ08PL	15,85
10	1	ZA41AZ10PL	15,85
12	1	ZA41AZ12PL	15,85
1 1/4"	2	ZA41AZ13.2PL	16,94
15	2	ZA41AZ15PL	16,94
3/8"	2	ZA41AZ16.7PL	16,94
18	2	ZA41AZ18PL	17,66
20	3	ZA41AZ20PL	18,36
1/2"	3	ZA41AZ21.3PL	18,36
22	3	ZA41AZ22PL	18,36
25	3	ZA41AZ25PL	18,47
3/4"	4	ZA41AZ26.7PL	20,61
28	4	ZA41AZ28PL	20,61
30	4	ZA41AZ30PL	20,61
1"	5	ZA41AZ33.3PL	23,36
35	5	ZA41AZ35PL	23,36
38	5	ZA41AZ38PL	23,36
42-1" 1/4	5	ZA41AZ42PL	23,36

TrAle® Clamps

Abrazaderas TrAle®

Schellen

Colliers TrAle®

Plastics polypropylene, light serie

Plásticos polipropileno, serie ligera

Polypropylenteile, Leichte Serie

Plastique polypropylene, série légère



DN	GRUPO GROUP	Referencia Part n°	€
6	1	A106C	*
8	1	A108C	*
10	1	A110C	*
12	1	A112C	*
1 1/4"	2	A213.2C	*
14	2	A214C	*
15	2	A215C	*
3/8"	2	A216.7C	*
16	2	A216C	*
18	2	A218C	*
19	3	A319C	*
20	3	A320C	*
1/2"	3	A321.3C	*
22	3	A322C	*
23	3	A323C	*
25	3	A325C	*
3/4"	4	A426.7C	*
28	4	A428C	*
30	4	A430C	*
32	5	A532C	*
1"	5	A533.7C	*
35	5	A535C	*
38	5	A538C	*
40	5	A540C	*
42-1 1/4	5	A542C	*
44.5	6	A644.5C	*
1 1/2	6	A648.3C	*
50.8	6	A650.8C	*

*Price per couple. See prices in Hydraulic and Pneumatic Connectors' Catalogue / *Precio por pareja. Ver precios en Tarifa Conducciones Hidráulicas y Neumáticas / *Preis für ein Paar. Vgl. Sie die Preise in der Preisliste Hydraulische und Pneumatische Verbindungen / *Prix par paire. Voir les prix dans le Catalogue Connectique Hydraulique et Pneumatique

Lower plate, light serie

Chapas inferiores, serie ligera

Unterbleche, Leichte Serie

Plaque inférieure, série légère



GRUPO GROUP	Referencia Part n°	€
1	ZAPIN1	9,96
2	ZAPIN2	10,34
3	ZAPIN3	10,66
4	ZAPIN4	11,10
5	ZAPIN5	11,86
6	ZAPIN6	14,79

Upper plate, light serie

Chapas superiores, serie ligera

Oberbleche, Leichte Serie

Plaque supérieure, série légère



GRUPO GROUP	Referencia Part n°	€
1	ZAPS1	3,18
2	ZAPS2	3,52
3	ZAPS3	3,98
4	ZAPS4	4,55
5	ZAPS5	5,28
6	ZAPS6	6,08

Allen screw, light serie

Tornillos Allen, serie ligera

Innensechskant-Schrauben, Leichte Serie

Vis Allen, série légère



ROSCA THREAD	GRUPO GROUP	Referencia Part n°	€
M6	1	ZAVTC1	0,73
M6	2	ZAVTC2	0,52
M6	3	ZAVTC3	1,40
M6	4	ZAVTC4	1,14
M6	5	ZAVTC5	1,26
M6	6	ZAVTC6	2,10

Price per unit / Precio por unidad / Preis pro Stück / Prix à l'unité

Hexagonal screw, light serie

Tornillos Hexagonales, serie ligera

Hexagonal-Schrauben, Leichte Serie

Vis Hexagonnel, série légère



ROSCA THREAD	GRUPO GROUP	Referencia Part n°	€
M6	1	ZAVTE1	0,65
M6	2	ZAVTE2	0,71
M6	3	ZAVTE3	1,32
M6	4	ZAVTE4	1,02
M6	5	ZAVTE5	0,92
M6	6	ZAVTE6	2,53

Price per unit / Precio por unidad / Preis pro Stück / Prix à l'unité

TrAle® Clamps

Abrazaderas TrAle®

Schellen

Colliers TrAle®

Stainless Steel Stack Screws Light Series

Tornillos Apilar Inox Serie Ligera

Schraube Stapelplatte Edelstahl Leichte Serie

Vis de pile en acier inoxydable série légère



ROSCA THREAD	GRUPO GROUP	Referencia Part n°	€
M6	1	ZAVTA1	6,95
M6	2	ZAVTA2	8,09
M6	3	ZAVTA3	9,21
M6	4	ZAVTA4	10,83
M6	5	ZAVTA5	11,53
M6	6	NEW ZAVTA6	12,50

Plates to pile up clamps, light serie

Chapas para apilar abrazaderas, serie ligera

Blech zum Stapeln von Schellen, Serie Leicht

Plaques pour empiler colliers, série légère



GRUPO GROUP	Referencia Part n°	€
1	ZAPA1	1,37
2	ZAPA2	1,64
3	ZAPA3	1,88
4	ZAPA4	2,12
5	ZAPA5	2,39
6	ZAPA6	3,35

TRALE®

ABRAZADERAS | CLAMPS

UNE TUS SISTEMAS DE TUBERÍA DE FORMA SEGURA
JOIN PIPE SYSTEMS SECURELY

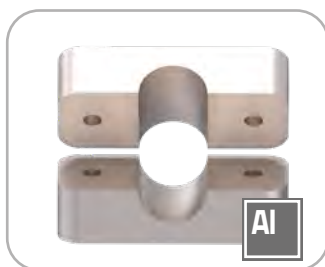
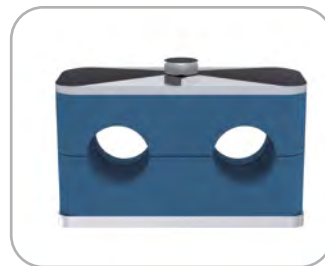
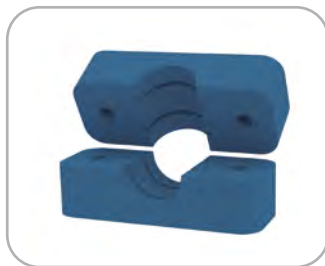

CONSULTA EL
CATÁLOGO DE
CONDUCCIONES



CHECK OUR
CONNECTORS
CATALOGUE

TrAle® Clamps

Abrazaderas TrAle®

Schellen

Colliers TrAle®

Elongated Weld Plate Light Series

Chapa Atornillar, Serie ligera

Längliche Schweißplatte Leichte Serie

Plaque à souder allongée, série légère



GRUPO GROUP	Referencia Part n°	€
1	ZAPT1	6,96
2	ZAPT2	7,35
3	ZAPT3	7,51
4	ZAPT4	7,85
5	ZAPT5	8,20
6	ZAPT6	16,56



Stainless Steel Jointed plate Light Series



Chapa Agrupar Inox Serie Ligera

Verbindungsplatte Edelstahl Leichte Serie

Plaque à joindre acier inoxydable série légère



GRUPO GROUP	N° ABRAZ CLAMP QTY.	Referencia Part n°	€
1	10	ZAPAG1	9,96
2	10	ZAPAG2	10,34
3	10	ZAPAG3	9,87
4	10	ZAPAG4	11,10
5	10	ZAPAG5	11,86
6	10	ZAPAG6	14,79

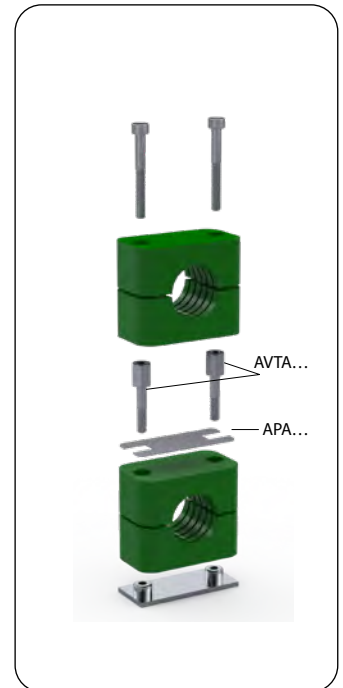
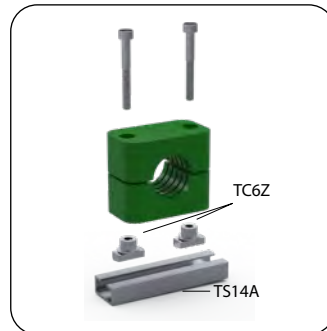
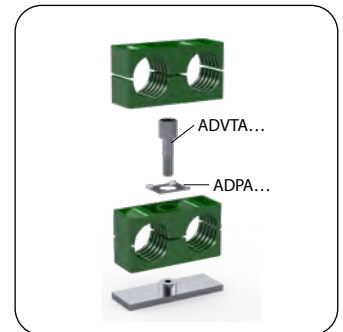

TrΔle® Clamps

Abrazaderas TrΔle®

Schellen

Colliers TrΔle®

Double clamp - parallel

Abrazaderas dobles completas

Doppelte Befestigungsschellen - komplett

Colliers de fixation doubles complets



DN	GRUPO GROUP	Referencia Part n°	€
6	1	ZAZCFS06	11,25
8	1	ZAZCFS08	11,25
10	1	ZAZCFS10	11,25
12	1	ZAZCFS12	11,25
14	2	ZAZCFS14	22,22
15	2	ZAZCFS15	22,22
16	2	ZAZCFS16	22,22
18	2	ZAZCFS18	22,22
20	3	ZAZCFS20	23,94
22	3	ZAZCFS22	23,94
25	3	ZAZCFS25	23,94
28	4	ZAZCFS28	29,22
30	4	ZAZCFS30	29,22
35	5	ZAZCFS35	34,60
38	5	ZAZCFS38	34,60
40	5	ZAZCFS40	34,60
42	5	ZAZCFS42	34,60

Double Lower plate

Chapas inferiores

Unterbleche

Plaques inférieures à souder double



ROSCA THREAD	GRUPO GROUP	Referencia Part n°	€
M6	1	ZADPIN1	6,22
M8	2	ZADPIN2	13,44
M8	3	ZADPIN3	14,47
M8	4	ZADPIN4	16,20
M8	5	ZADPIN5	19,77

Double Upper plate

Chapas superiores

Oberbleche

Plaques supérieures de protection double



GRUPO GROUP	Referencia Part n°	€
1	ZADPS1	3,21
2	ZADPS2	4,94
3	ZADPS3	5,48
4	ZADPS4	9,35
5	ZADPS5	11,45

Double plastics polypropylene

Plásticos polipropileno dobles

Polypropylenteile doppelt

Plastiques polypropylene doubles



DN	GRUPO GROUP	Referencia Part n°	€
6	1	AD106C	*
8	1	AD108C	*
10	1	AD110C	*
12	1	AD112C	*
1/4"	2	AD213.2C	*
14	2	AD214C	*
15	2	AD215C	*
3/8"	2	AD216.7C	*
16	2	AD216C	*
18	2	AD218C	*
19	3	AD319C	*
20	3	AD320C	*
1/2"	3	AD321.3C	*
22	3	AD322C	*
25	3	AD325C	*
3/4"	4	AD426.7C	*
28	4	AD428C	*
30	4	AD430C	*
32	5	AD532C	*
1"	5	AD533.3C	*
35	5	AD535C	*
38	5	AD538C	*
40	5	AD540C	*
42	5	AD542C	*

*Price per couple. See prices in Hydraulic and Pneumatic Connectors' Catalogue / *Precio por pareja. Ver precios en Tarifa Conducciones Hidráulicas y Neumáticas / *Preis für ein Paar. Vgl. Sie die Preise in der Preisliste Hydraulische und Pneumatische Verbindungen / *Prix par paire. Voir les prix dans le Catalogue Connectique Hydraulique et Pneumatique

Hexagonal screw

Tornillos cabeza hexagonal

Hexagonalkopf-Schrauben

Vis hexagonale



ROSCA THREAD	GRUPO GROUP	Referencia Part n°	€
M6	1	ZADVTE1	0,63
M8	2	ZADVTE2	2,33
M8	3	ZADVTE3	2,28
M8	4	ZADVTE4	2,30
M8	5	ZADVTE5	2,65

Price per unit / Precio por unidad / Preis pro Stück / Prix à l'unité

TrΔle® Clamps

Abrazaderas TrΔle®

Schellen

Colliers TrΔle®

Plates to pile up double clamps



Chapa apilar abrazadera doble

Stapelplatte Doppelschelle

Plaques pour empiler colliers doubles



GRUPO GROUP	Referencia Part n°	€
1	ZADPA1	2,37
2/3/4/5	ZADPA2	2,37

Stack Screws double clamps



Tornillo apilar abrazadera doble

Schraube Stapelplatte Doppelschelle

Vis de pile colliers doubles



ROSCA THREAD	GRUPO GROUP	Referencia Part n°	€
M6	2	ZADVTA2	9,61
M6	3	ZADVTA3	9,87
M6	4	ZADVTA4	10,27
M6	5	ZADVTA5	10,41
M6	6	ZADVTA6	*

For Group 1: ZAVTA1 (Light) / Para Grupo 1: ZAVTA1 (ligera) / Für Gruppe 1: ZAVTA1 (leicht) / Pour le Groupe 1: ZAVTA1 (légère)

Jointed plate double clamps



Chapa agrupar abrazadera doble

Verbindungsplatte Doppelschelle

Plaque à joindre colliers doubles



ROSCA THREAD	GRUPO GROUP	N° ABRAZADERAS CLAMP QTY.	Referencia Part n°	€
M6	1	5	ZADPAG1	6,41
M8	2	5	ZADPAG2	14,85
M8	3	5	ZADPAG3	15,81

TrΔle® Clamps

Abrazaderas TrΔle®

Schellen

Colliers TrΔle®

Heavy Series Stainless Steel Clamps

Abrazaderas Inox Serie pesada completas

Edelstahl-Schelle Schwere Serie

Pinces en acier inoxydable série lourde



DN	GRUPO GROUP	Referencia Part n°	€
6	1	ZAZCPS06	53,67
8	1	ZAZCPS08	55,97
10	1	ZAZCPS10	53,67
12	1	ZAZCPS12	53,63
1/4"	1	ZAZCPS13.2	53,67
14	1	ZAZCPS14	53,67
15	1	ZAZCPS15	53,67
16	1	ZAZCPS16	53,67
3/8"	1	ZAZCPS17.2	53,67
18	1	ZAZCPS18	53,67
20	2	ZAZCPS20	68,88
1/2"	2	ZAZCPS21.3	68,88
22	2	ZAZCPS22	68,88
25	2	ZAZCPS25	68,88
3/4"	2	ZAZCPS26.7	68,88
28	2	ZAZCPS28	68,88
30	2	ZAZCPS30	68,88
32	3	ZAZCPS32	85,68
1"	3	ZAZCPS33.3	85,68
35	3	ZAZCPS35	85,68
38	3	ZAZCPS38	85,68
40	3	ZAZCPS40	85,68
42 - 1" 1/4	3	ZAZCPS42	85,68
45	4	ZAZCPS45	151,10
48-1" 1/2	4	ZAZCPS48	151,10
50	4	ZAZCPS50	151,10
55	4	ZAZCPS55	151,10
2"	4	ZAZCPS60.3	151,10
65	4	ZAZCPS65	151,10
70	4	ZAZCPS70	151,10

Plastics polypropylene, heavy serie

Plasticos polipropileno, serie pesada

Polypropylenteil, Schwere Serie

Plastique polypropylene, série lourde



DN	GRUPO GROUP	Referencia Part n°	€
6	1	AMPP106C	*
8	1	AMPP108C	*
10	1	AMPP110C	*
12	1	AMPP112C	*
1/4"	1	AMPP113.2C	*
14	1	AMPP114C	*
15	1	AMPP115C	*
16	1	AMPP116C	*
3/8"	1	AMPP117.2C	*
18	1	AMPP118C	*
20	2	AMPP220C	*
1/2"	2	AMPP221.3C	*
22	2	AMPP222C	*
25	2	AMPP225C	*
3/4"	2	AMPP226.7C	*
28	2	AMPP228C	*
30	2	AMPP230C	*
30	3	AMPP330C	*
32	3	AMPP332C	*
1"	3	AMPP333.3C	*
35	3	AMPP335C	*
38	3	AMPP338C	*
40	3	AMPP340C	*
42	3	AMPP342C	*
38	4	AMPP438C	*
42- 1" 1/4	4	AMPP442C	*
45	4	AMPP445C	*
48-1" 1/2	4	AMPP448C	*
50	4	AMPP450C	*
55	4	AMPP455C	*
2"	4	AMPP460.3C	*
65	4	AMPP465C	*
70	4	AMPP470C	*

*Price per couple. See prices in Hydraulic and Pneumatic Connectors' Catalogue / *Precio por pareja. Ver precios en Tarifa Conducciones Hidráulicas y Neumáticas / *Preis für ein Paar. Vgl. Sie die Preise in der Preisliste Hydraulische und Pneumatische Verbindungen / *Prix par paire. Voir les prix dans le Catalogue Connectique Hydraulique et Pneumatique

CRIMPING FITTINGS
FOR HOSES

PIPE
FITTINGS

PIPE
FITTINGS II

ADAPTORS

WELDING
FITTINGS

INDUSTRIAL
FITTINGS

ACCESSORIES

CONTROL
COMPONENTS

FLOW
MEASURING

TRALE LOK

TrAle® Clamps

Abrazaderas TrAle®

Schellen

Colliers TrAle®

Lower plate, heavy serie

Chapas inferiores, serie pesada

Unterbleche, Schwere Serie

Plaque inférieure, série lourde



ROSCA THREAD	GRUPO GROUP	Referencia Part n°	€
M10	1	ZAPINP1	35,52
M10	2	ZAPINP2	46,82
M10	3	ZAPINP3	58,10
M12	4	ZAPINP4	88,53

Upper plate, heavy serie

Chapas superiores, serie pesada

Oberbleche, Schwere Serie

Plaque supérieure, série lourde



GRUPO GROUP	Referencia Part n°	€
1	ZAPSP1	16,25
2	ZAPSP2	18,41
3	ZAPSP3	24,09
4	ZAPSP4	55,12

Screw, heavy serie

Tornillos, serie pesada

Schrauben, Schwere Serie

Vis, série lourde



ROSCA THREAD	GRUPO GROUP	Referencia Part n°	€
M10	1	ZAVTEP1	4,20
M10	2	ZAVTEP2	5,00
M10	3	ZAVTEP3	5,71
M12	4	ZAVTEP4	12,08

Price per unit / Precio por unidad / Preis pro Stück / Prix à l'unité

Stack Screws, heavy serie

Tornillo apilar serie pesada

Schraube Stapelplatte Schwere Serie

Vis de pile, série lourde



ROSCA THREAD	GRUPO GROUP	Referencia Part n°	€
M10	1	ZAPVTAP1	13,31
M10	2	ZAPVTAP2	14,89
M10	3	ZAPVTAP3	16,81
M12	4	ZAPVTAP4	36,55

Plates to pile up clamps, heavy serie

Chapa apilar serie pesada

Stapelplatte Schwere Serie

Plaques pour empiler colliers, série lourde



GRUPO GROUP	Referencia Part n°	€
1	ZAPAP1	20,74
2	ZAPAP2	23,14
3	ZAPAP3	44,46
4	ZAPAP4	57,81

Rail accessories

Accesorios para carril

Zubehör Schiene

Accessoires pour rail



ROSCA THREAD	DETALLE DESCRIPTION	Referencia Part n°	€
M6	NUT	TC6I	12,22
M8	NUT	TC8I	17,58
M10	NUT	TC10I	17,57
M12	NUT	TC12I	18,70
--	RAIL	TS11I	73,37
--	RAIL	TS14I	81,14
--	RAIL	TSP22I	*

NEW

NEW

REQUEST OUR CONNECTORS CATALOGUE

CONSULTA EL CATÁLOGO DE CONDUCCIONES

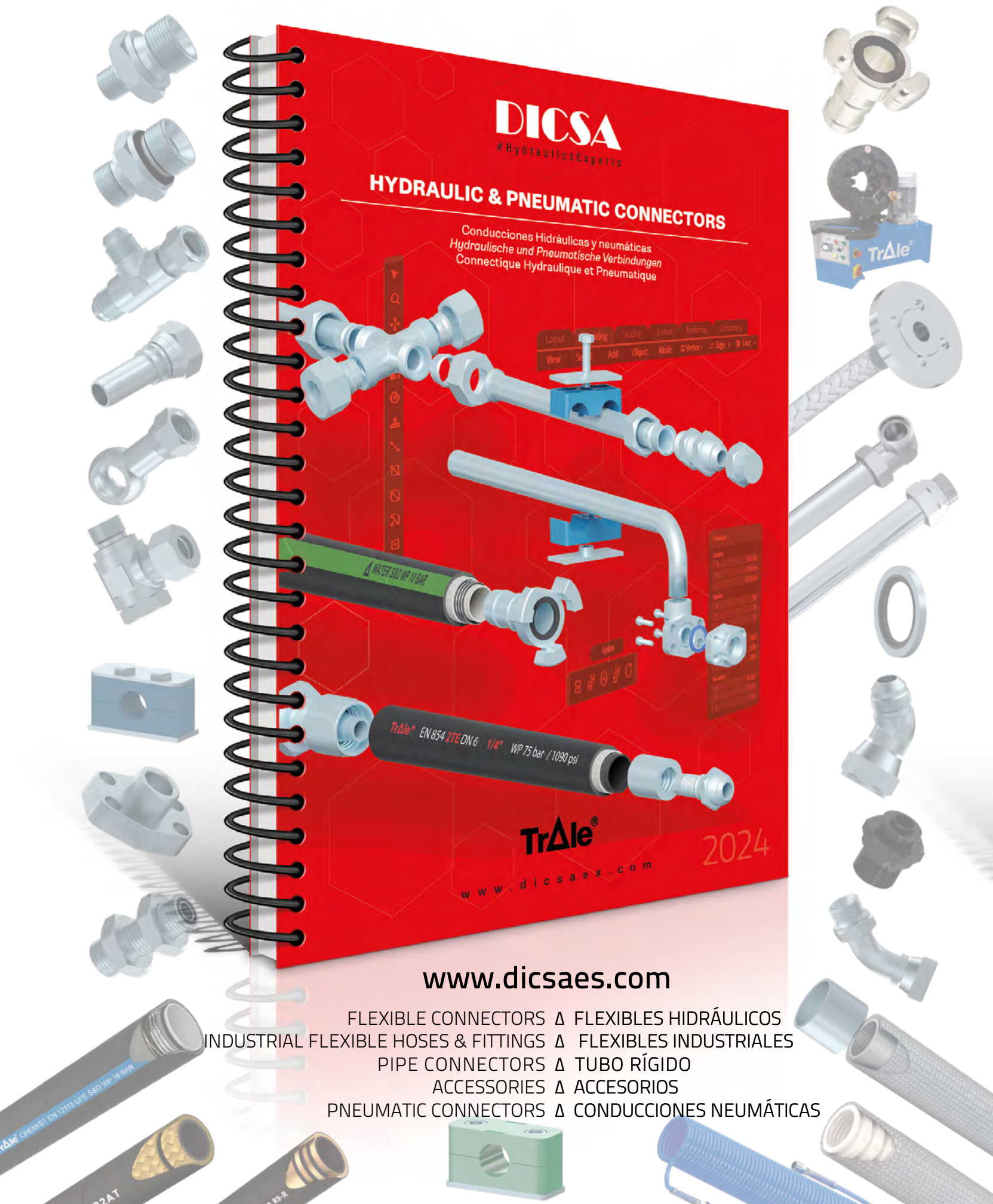

www.dicsaes.com

FLEXIBLE CONNECTORS Δ FLEXIBLES HIDRÁULICOS
INDUSTRIAL FLEXIBLE HOSES & FITTINGS Δ FLEXIBLES INDUSTRIALES
PIPE CONNECTORS Δ TUBO RÍGIDO
ACCESSORIES Δ ACCESORIOS
PNEUMATIC CONNECTORS Δ CONDUCCIONES NEUMÁTICAS

BSP Adaptors | 170

Adaptadores BSP
Adapter BSP
Adapteurs BSP

NPT Adaptors | 180

Adaptadores NPT
Adapter NPT
Adapteurs NPT

O'Ring Boss Adaptors | 185

Adaptadores O'Ring Boss
Adapter O'Ring Boss
Adapteurs O'Ring Boss

ORFS Adaptors | 187

Adaptadores ORFS
Adapter ORFS
Adapteurs ORFS



04

ADAPTORS

Adaptadores

Adaptors

Adapteurs

BSP Adaptors

Adaptadores BSP
Adapter BSP
Adapteurs BSP

Straight male adaptors ▪ Uniones rectas macho ▪ Gerade Verschraubungen m ▪ Unions mâle | 170



Z1010 Z1010_WD Z1011 Z1020 Z1020_WD Z1016 Z1014 Z1024 Z1012 Z1022

Adaptors male-female ▪ Uniones rectas macho-hembra ▪ Gerade Verschraubungen m - w ▪ Unions mâle-femelle | 172



Z1060 Z1060 Z1061 Z1172 Z1170 Z1173 Z1150

Plugs ▪ Tapones ▪ Stopfen ▪ Bouchons | 174



Z1072 Z1070 Z1075

Female adaptors and bulkheads ▪ Uniones hembra y pasatabiques ▪ Verschraubungen w und Schottverschraubungen ▪ Unions femelle et passe-cloison | 175

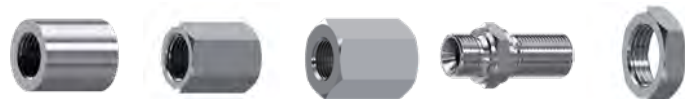

Z1310 Z1031 Z1031 Z1160 Z1161

Banjos ▪ Orientables ▪ Ringaugen ▪ Adapteurs orientables | 176



Z1090 Z1092 Z1140

Joints ▪ Juntas metal FKM ▪ USIT-Dichtringe ▪ Bague BS | 176



ZVT210 ZVT320

Elbows ▪ Codos accesoriales ▪ Winkel - W ▪ Adapteurs coude accessoirel | 177



Z1194 ZA1196 Z1195 ZA1195

Forging elbows ▪ Codos en forja ▪ W-Guss-Stücke ▪ Adapteurs coude en forge | 178



Z1190 Z1192 Z1197 Z1191 Z1193 Z1196 Z1198 Z1183

Forging Tees and croos ▪ Te y cruces en forja ▪ T-Guss-Stück und überqueren ▪ Adapteurs Tés en forge et des croix | 179



Z1220 Z1222 Z1224 Z1228 Z1226 Z1221 Z1223 Z1227

NPT Adaptors

Adaptadores NPT
Adapter NPT
Adpteurs NPT

Straight male adaptors ▪ Uniones rectas macho-macho ▪ Gerade Verschraubungen m - m ▪ Unions mâle | 180



Z1015

ZN1015

Adaptors male-female ▪ Uniones rectas macho-hembra ▪ Gerade Verschraubungen m - w ▪ Unions mâle-femelle | 180



ZN1060

ZN1150

ZN1170

ZN1174

Plugs ▪ Tapones ▪ Stopfen ▪ Bouchons | 181



ZN1072

ZN1070

ZN1071

Female adaptors and bulkheads ▪ Uniones hembra y pasatabiques ▪ Verschraubungen w und Schottverschraubungen
▪ Unions femelle et passe cloisson | 181



ZN1031

Forging elbows ▪ Codos en forja ▪ W-Guss-Stücke ▪ Adapteurs coude en forge | 182



ZN1190

ZN1193

ZN1196

ZN1198

ZN1396

ZN1393

Forging tees ▪ Tes en forja ▪ T-Verschraubungen Guss ▪ Adapteurs Té en forge | 183



ZN1220

ZN1226

O'Ring Boss Adaptors

Adaptadores O'Ring Boss

Adapter O'Ring Boss

Adapteurs O'Ring Boss

Straight male adaptors ▪ Uniones rectas macho ▪ Gerade Verschraubungen m ▪ Unions mâle

| 185



Z56464

Z5220

Z53474

Z56401

Adaptors male-female ▪ Uniones rectas macho-hembra ▪ Gerade Verschraubungen m - w ▪ Unions mâle-femelle

| 185



Z5380

Z56405

Plugs ▪ Tapones ▪ Stopfen ▪ Bouchons

| 185



Z56408

Z56409

Forging elbows and tees ▪ Codos en forja ▪ W- und T-Guss-Stücke ▪ Adapteurs coude et té en forge

| 186



Z5575

Forging Tees ▪ Tes en forja ▪ T-Verschraubungen Guss ▪ Adapteurs Té en forge

| 186



Z56803

Z56804

ORFS Adaptors

Adaptadores ORFS

Adapter ORFS

Adapteurs ORFS

ORFS Nuts and nipples ▪ Conos y tuercas ORFS ▪ Ü-Muttern und Konusse ORFS ▪ Écrous et collets ORFS

187



ZOR102



ZOR1273

Plugs ▪ Tapones ▪ Verschlüsse ▪ Bouchons

187



ZOR104



ZOR105

ORFS Straight unions ▪ Uniones rectas ORFS ▪ Gerade ORFS-Verschraubungen ▪ Unions droites ORFS

187



ZOR200



ZOR202



ZOR1017



ZOR106



ZOR301



ZOR204



ZOR302



ZOR305

ORFS Elbows ▪ Codos en forja ORFS ▪ ORFS-Winkel - w ORFS ▪ Coudes ORFS

189



ZOR405



ZOR600

ORFS Tees ▪ Tes en forja ORFS ▪ T-Verschraubungen ORFS ▪ Tés ORFS

189



ZOR700



ZOR701



ZOR702



JVORFS

CRIMPING FITTINGS
FOR HOSES

PIPE
FITTINGS

PIPE
FITTINGS II

ADAPTORS

WELDING
FITTINGS

INDUSTRIAL
FITTINGS

ACCESSORIES

CONTROL
COMPONENTS

FLOW
MEASURING

TRALE LOK

BSP Adaptors

Adaptadores BSP
Adapter BSP
Adapteurs BSP

Adaptor male BSP 60° - male BSP 60°

Adaptador macho - macho BSP cono 60°

Doppelnippel AGR-AGR

Adapteur mâle BSP - mâle BSP cône 60°



ROSCA THREAD		Referencia Part n°	€
1/8" BSP	1/8" BSP	Z101002	9,03
1/4" BSP	1/4" BSP	Z101004	8,58
1/4" BSP	1/4" BSP	Z101004H19	10,77
3/8" BSP	3/8" BSP	Z101006	10,03
1/2" BSP	1/2" BSP	Z101008	13,38
5/8" BSP	5/8" BSP	Z101010	28,83
3/4" BSP	3/4" BSP	Z101012	20,16
1" BSP	1" BSP	Z101016	40,39
1 1/4" BSP	1 1/4" BSP	Z101020	60,85
1 1/2" BSP	1 1/2" BSP	Z101024	73,59
2" BSP	2" BSP	Z101032	114,20
2" BSP	2" BSP	Z101032H70	145,74
2 1/2" BSP	2 1/2" BSP	Z101040	214,26
3" BSP	3" BSP	Z101048	317,41

Adaptor male BSP 60° - male BSP 60° captive seal

Adaptador macho - macho BSP cono 60° con junta encastrada

Doppelnippel AGR-AGR WD

Adapteur mâle BSP - mâle BSP cône 60° avec joint plat



ROSCA THREAD		Referencia Part n°	€
1/4" BSP	1/4" BSP	Z101004WD	15,14
3/8" BSP	3/8" BSP	Z101006WD	16,80
1/2" BSP	1/2" BSP	Z101008WD	21,63
3/4" BSP	3/4" BSP	Z101012WD	28,58
1" BSP	1" BSP	Z101016WD	48,87

Adaptor male BSP - male BSP flat seat

Adaptador macho - macho BSP asiento plano

Doppelnippel AGR-AGR flachdichtend

Adapteur mâle BSP - mâle BSP fond plat



ROSCA THREAD		Referencia Part n°	€
1/4" BSP	1/4" BSP	Z101104	10,87
3/8" BSP	3/8" BSP	Z101106	14,27
1/2" BSP	1/2" BSP	Z101108	17,83
3/4" BSP	3/4" BSP	Z101112	19,91
1" BSP	1" BSP	Z101116	41,67
1 1/4" BSP	1 1/4" BSP	Z101120	76,56
1 1/2" BSP	1 1/2" BSP	Z101124	83,36
2" BSP	2" BSP	Z101132	117,46

Reducer male adaptor BSP 60° - male BSP 60°

Reductor macho - macho BSP cono 60°

Reduziernippel AGR-AGR

Réduction mâle BSP - mâle BSP cône 60°



ROSCA THREAD		Referencia Part n°	€
1/8" BSP	1/4" BSP	Z10200204	9,72
1/8" BSP	1/4" BSP	Z10200204H19	13,05
1/8" BSP	3/8" BSP	Z10200206	14,09
1/8" BSP	1/2" BSP	Z10200208	19,08
1/4" BSP	3/8" BSP	Z10200406	10,74
1/4" BSP	1/2" BSP	Z10200408	14,89
1/4" BSP	3/4" BSP	Z10200412	26,79
3/8" BSP	1/2" BSP	Z10200608	14,78
3/8" BSP	3/4" BSP	Z10200612	23,78
3/8" BSP	1" BSP	Z10200616	38,98
1/2" BSP	3/4" BSP	Z10200812	21,30
1/2" BSP	1" BSP	Z10200816	37,30
1/2" BSP	1 1/4" BSP	Z10200820*	63,57
1/2" BSP	1 1/2" BSP	Z10200824*	85,45
5/8" BSP	1/2" BSP	Z10201008	32,60
5/8" BSP	3/4" BSP	Z10201012	34,37
3/4" BSP	1" BSP	Z10201216	39,66
3/4" BSP	1 1/4" BSP	Z10201220	62,67
1" BSP	1 1/4" BSP	Z10201620	57,38
1" BSP	1 1/2" BSP	Z10201624	73,45
1 1/4" BSP	1 1/2" BSP	Z10202024	76,56
1 1/4" BSP	2" BSP	Z10202032	143,06
1 1/2" BSP	2" BSP	Z10202432	120,25
1 1/2" BSP	2" BSP	Z10202432H70	150,68
2" BSP	2 1/2" BSP	Z10203240	257,58
2" BSP	3" BSP	Z10203248	335,11
2 1/2" BSP	3" BSP	Z10204048	326,93

*Until end of stock / Hasta fin de existencias / Bis zum Ende des Lagerbestandes / Jusqu'à la fin du stock

Reducer male adaptor BSP 60° - male BSP 60° captive seal

Reductor macho - macho BSP cono 60° con junta encastrada

Reduziernippel AGR-AGR WD

Réduction mâle BSP - mâle BSP cône 60° avec joint plat



ROSCA THREAD		Referencia Part n°	€
1/4" BSP	3/8" BSP	Z10200406WD	18,82
1/4" BSP	1/2" BSP	Z10200408WD	28,02
3/8" BSP	1/2" BSP	Z10200608WD	24,05
1/2" BSP	3/4" BSP	Z10200812WD	31,31
3/4" BSP	1" BSP	Z10201216WD	49,10

BSP Adaptors

Adaptadores BSP
Adapter BSP
Adapteurs BSP

Adaptor male BSPT - male BSPT

Adaptador macho - macho BSPT

Doppelnippel AGRR-AGRR

Adapteur mâle gaz conique BSPT - mâle gaz conique BSPT



ROSCA THREAD		Referencia Part n°	€
1/4" BSPT	1/8" BSPT	Z10160402	14,79
1/4" BSPT	1/4" BSPT	Z10160404	9,38
1/4" BSPT	3/8" BSPT	Z10160406	13,81
3/8" BSPT	3/8" BSPT	Z10160606	13,54
1/2" BSPT	1/2" BSPT	Z10160808	15,38
3/4" BSPT	3/4" BSPT	Z10161212	20,11
1" BSPT	3/4" BSPT	Z10161612	42,82
1" BSPT	1" BSPT	Z10161616	40,79
1" 1/4 BSPT	1" 1/4 BSPT	Z10162020	72,12
1" 1/2 BSPT	1" 1/2 BSPT	Z10162424	87,35
2" BSPT	2" BSPT	Z10163232	134,31

Adaptor male BSP 60° - male NPT

Adaptador macho BSP 60° - macho NPT

Doppelnippel AGR-AGN

Adapteur mâle BSP cône 60° - mâle BRIGGS (NPT)



ROSCA THREAD		Referencia Part n°	€
1/8" BSP	1/8" NPT	Z101402	12,47
1/4" BSP	1/4" NPT	Z101404	8,99
3/8" BSP	3/8" NPT	Z101406	12,34
1/2" BSP	1/2" NPT	Z101408	13,27
3/4" BSP	3/4" NPT	Z101412	19,68
1" BSP	1" NPT	Z101416	30,22
1" 1/4 BSP	1" 1/4 NPT	Z101420	54,11
1" 1/2 BSP	1" 1/2 NPT	Z101424	68,76
2" BSP	2" NPT	Z101432	113,34

Reducer adaptor male BSP 60° - male NPT

Reductor macho BSP 60° - macho NPT

Reduziernippel AGR-AGN

Réduction mâle BSP cône 60° - mâle BRIGGS NPT



ROSCA THREAD		Referencia Part n°	€
1/8" BSP	1/4" NPT	Z10240204	16,33
1/4" BSP	1/8" NPT	Z10240402	17,41
1/4" BSP	3/8" NPT	Z10240406	14,65
1/4" BSP	1/2" NPT	Z10240408	20,06
3/8" BSP	1/4" NPT	Z10240604	16,54
3/8" BSP	1/2" NPT	Z10240608	18,45
3/8" BSP	3/4" NPT	Z10240612	23,12
1/2" BSP	3/8" NPT	Z10240806	19,04
1/2" BSP	3/4" NPT	Z10240812	21,64
5/8" BSP	3/4" NPT	Z10241012	38,42
3/4" BSP	1/4" NPT	Z10241204	36,45
3/4" BSP	3/8" NPT	Z10241206	26,57
3/4" BSP	1/2" NPT	Z10241208	27,79
3/4" BSP	1" NPT	Z10241216	37,39
3/4" BSP	1" 1/4 NPT	Z10241220	72,12
3/4" BSP	1" 1/2 NPT	Z10241224	84,51
1" BSP	1/2" NPT	Z10241608	35,67
1" BSP	3/4" NPT	Z10241612	34,58
1" BSP	1" 1/4 NPT	Z10241620	61,19
1" 1/4 BSP	1" NPT	Z10242016	65,60
1" 1/4 BSP	1" 1/2 NPT	Z10242024	82,26
1" 1/2 BSP	1" 1/4 NPT	Z10242420	89,50
1" 1/2 BSP	2" NPT	Z10242432	120,00
2" BSP	1" 1/2 NPT	Z10243224	115,65

Adaptor male BSP 60° - male BSPT

Adaptador macho BSP 60° - macho BSPT

Doppelnippel AGR-AGRR

Adapteur mâle BSP cône 60° - mâle gaz conique BSPT



ROSCA THREAD		Referencia Part n°	€
1/8" BSP	1/8" BSPT	Z101202	10,08
1/4" BSP	1/4" BSPT	Z101204	8,71
3/8" BSP	3/8" BSPT	Z101206	9,88
1/2" BSP	1/2" BSPT	Z101208	12,20
3/4" BSP	3/4" BSPT	Z101212	17,43
1" BSP	1" BSPT	Z101216	34,73
1" 1/4 BSP	1" 1/4 BSPT	Z101220	51,39
1" 1/2 BSP	1" 1/2 BSPT	Z101224	67,16
2" BSP	2" BSPT	Z101232	113,53

BSP Adaptors

Adaptadores BSP
Adapter BSP
Adapteurs BSP

Reducer adaptor male BSP 60° - male BSPT

Reductor macho BSP 60° - macho BSPT

Reduziernippel AGR-AGR

Réduction mâle BSP cône 60° - mâle gaz conique
BSPT



ROSCA THREAD	ROSCA (H) THREAD (F)	Referencia Part n°	€
1/8" BSP	1/4" BSPT	Z10220204	20,85
1/4" BSP	1/8" BSPT	Z10220402	14,70
1/4" BSP	3/8" BSPT	Z10220406	16,28
1/4" BSP	1/2" BSPT	Z10220408	18,91
1/4" BSP	3/4" BSPT	Z10220412	35,50
3/8" BSP	1/2" BSPT	Z10220608	13,95
3/8" BSP	3/4" BSPT	Z10220612	27,96
1/2" BSP	1/4" BSPT	Z10220804	23,49
1/2" BSP	3/8" BSPT	Z10220806	17,47
1/2" BSP	3/4" BSPT	Z10220812	22,56
1/2" BSP	1" BSPT	Z10220816	38,80
5/8" BSP	3/4" BSPT	Z10221012	22,10
3/4" BSP	1/4" BSPT	Z10221204	28,70
3/4" BSP	3/8" BSPT	Z10221206	21,10
3/4" BSP	1/2" BSPT	Z10221208	21,86
3/4" BSP	1" BSPT	Z10221216	31,03
1" BSP	3/4" BSPT	Z10221612	31,44
1" BSP	1"1/4 BSPT	Z10221620	60,58
1" BSP	2" BSPT	Z10221632	129,32
1"1/4 BSP	1" BSPT	Z10222016	66,43
1"1/4 BSP	1"1/2 BSPT	Z10222024	72,07
1"1/4 BSP	2" BSPT	Z10222032	139,66
1 1/2" BSP	1"1/4 BSPT	Z10222420	75,56
1 1/2" BSP	2" BSPT	Z10222432	131,89

Adaptor male BSP 60° - fixed female BSP

Prolongador macho BSP 60° - hembra fija BSP

Adapter AGR-IGR

Prolongateur mâle BSP cône 60° - femelle gaz fixe



ROSCA(M) THREAD (M)	ROSCA(H) THREAD(F)	Referencia Part n°	€
1/8" BSP	1/8" BSP	Z106002	13,64
1/4" BSP	1/4" BSP	Z106004	13,58
3/8" BSP	3/8" BSP	Z106006	14,18
1/2" BSP	1/2" BSP	Z106008	18,52
3/4" BSP	3/4" BSP	Z106012	24,11
1" BSP	1" BSP	Z106016	39,45
1"1/4 BSP	1"1/4 BSP	Z106020	74,70
1"1/2 BSP	1"1/2 BSP	Z106024	82,06
2" BSP	2" BSP	Z106032	140,73

Reducer adaptor male BSP 60° - fixed female BSP

Reductor macho BSP 60° - hembra fija BSP

Reduzierstück AGR fest - IGR fest

Prolongateur réducteur mâle BSP cône 60° -
femelle gaz



ROSCA (M) THREAD (M)	ROSCA (H) THREAD (F)	Referencia Part n°	€
1/8" BSP	1/4" BSP	Z10600204	17,40
1/8" BSP	3/8" BSP	Z10600206	22,23
1/4" BSP	1/8" BSP	Z10600402	18,53
1/4" BSP	3/8" BSP	Z10600406	20,32
1/4" BSP	1/2" BSP	Z10600408	24,67
3/8" BSP	1/4" BSP	Z10600604	16,42
3/8" BSP	1/2" BSP	Z10600608	21,13
1/2" BSP	1/4" BSP	Z10600804	23,30
1/2" BSP	3/8" BSP	Z10600806	18,84
1/2" BSP	3/4" BSP	Z10600812	26,40
1/2" BSP	1" BSP	Z10600816	46,91
3/4" BSP	3/8" BSP	Z10601206	23,16
3/4" BSP	1/2" BSP	Z10601208	22,50
3/4" BSP	1" BSP	Z10601216	41,04
1" BSP	3/4" BSP	Z10601612	43,80
1" BSP	1"1/4 BSP	Z10601620	76,04
1" BSP	1"1/2 BSP	Z10601624	104,35
1"1/4 BSP	1" BSP	Z10602016	68,89
1"1/2 BSP	1"1/4 BSP	Z10602420	91,03
1"1/2 BSP	2" BSP	Z10602432	141,73
2" BSP	1"1/2 BSP	Z10603224	142,62

Adaptor male BSPT - fixed female BSP

Prolongador macho BSPT - hembra fija BSP

Adapter AGR BSPT - IG BSP

Prolongateur mâle BSPT - femelle gaz fixe



ROSCA THREAD	ROSCA (H) THREAD (F)	Referencia Part n°	€
1/4" BSPT	1/4" BSP	Z106104	12,81
3/8" BSPT	3/8" BSP	Z106106	16,41
1/2" BSPT	1/2" BSP	Z106108	23,35
3/4" BSPT	3/4" BSP	Z106112	29,12
1" BSPT	1" BSP	Z106116	53,65

NEW

BSP Adaptors

Adaptadores BSP

Adapter BSP

Adpteurs BSP

Adaptor BSP 60° swivel female - BSP 60° swivel female

Adaptador hembra giratoria - hembra giratoria BSP 60°

Adapter BSP (60°) w mit Drallmutter

Adapteur femelle tournante BSP 60° - femelle tournante BSP 60°



ROSCA THREAD	ROSCA THREAD	Referencia Part n°	€
1/4" BSP	1/4" BSP	Z117204	19,00
3/8" BSP	3/8" BSP	Z117206	20,54
1/2" BSP	1/2" BSP	Z117208	25,23
3/4" BSP	3/4" BSP	Z117212	37,41
1" BSP	1" BSP	Z117216	63,74
1" 1/4 BSP	1" 1/4 BSP	Z117220	95,57
1" 1/2 BSP	1" 1/2 BSP	Z117224	107,35
2" BSP	2" BSP	Z117232	179,23

Adaptor male BSP 60° - swivel female BSP 60°

Adaptador macho - hembra giratoria BSP cono 60°

Adapter m - w mit Drallmutter BSP kon. 60°

Adapteur mâle BSP - femelle tournante BSP cône 60°



ROSCA (M) THREAD (M)	ROSCA (H) THREAD (F)	Referencia Part n°	€
1/8" BSP	1/8" BSP	Z117002	16,90
1/4" BSP	1/4" BSP	Z117004	13,74
1/4" BSP	1/4" BSP	Z117004H19	21,27
3/8" BSP	3/8" BSP	Z117006	17,03
1/2" BSP	1/2" BSP	Z117008	23,50
3/4" BSP	3/4" BSP	Z117012	29,78
1" BSP	1" BSP	Z117016	52,79
1" 1/4 BSP	1" 1/4 BSP	Z117020	85,43
1" 1/2 BSP	1" 1/2 BSP	Z117024	103,88
2" BSP	2" BSP	Z117032	188,73

Reducer male BSP 60° - swivel female BSP 60°

Reductor macho - hembra giratoria BSP cono 60°

Reduziernippel AGR-DKR

Réduction mâle BSP - femelle tournante BSP cône 60°



ROSCA (M) THREAD (M)	ROSCA (H) THREAD (F)	Referencia Part n°	€
1/8" BSP	1/4" BSP	Z11730204	16,88
1/4" BSP	1/8" BSP	Z11730402	19,38
1/4" BSP	3/8" BSP	Z11730406	21,37
3/8" BSP	1/4" BSP	Z11730604	23,69
3/8" BSP	1/2" BSP	Z11730608	23,27
1/2" BSP	3/8" BSP	Z11730806	25,00
1/2" BSP	3/4" BSP	Z11730812	31,83
3/4" BSP	1/2" BSP	Z11731208	34,38
3/4" BSP	1" BSP	Z11731216	52,84
1" BSP	3/4" BSP	Z11731612	53,61
1" BSP	1" 1/4 BSP	Z11731620	85,71
1" 1/4 BSP	1" BSP	Z11732016	103,07
1" 1/4 BSP	1" 1/2 BSP	Z11732024	113,46
1" 1/2 BSP	1" 1/4 BSP	Z11732420	113,93
1" 1/2 BSP	2" BSP	Z11732432	173,13
2" BSP	1" 1/2 BSP	Z11733224	174,69

BSP Adaptors

Adaptadores BSP

Adapter BSP

Adapteurs BSP

Reducer plug male BSP 60° - fixed female BSP

Tapón reductor macho BSP 60° - hembra fija BSP

Reduziernippel AGR-IGR fest

Bouchon réducteur mâle BSP cône 60° - femelle gaz



ROSCA (M) THREAD (M)	ROSCA (H) THREAD (F)	Referencia Part n°	€
1/4" BSP	1/8" BSP	Z11500402	11,24
3/8" BSP	1/8" BSP	Z11500602	15,11
3/8" BSP	1/4" BSP	Z11500604	15,33
1/2" BSP	1/4" BSP	Z11500804	17,53
1/2" BSP	3/8" BSP	Z11500806	16,22
3/4" BSP	1/2" BSP	Z11501208	19,26
1" BSP	1/2" BSP	Z11501608	30,93
1" BSP	3/4" BSP	Z11501612	27,61
1" 1/4 BSP	3/4" BSP	Z11502012	48,17
1" 1/4 BSP	1" BSP	Z11502016	47,88
1" 1/2 BSP	1" BSP	Z11502416	65,49
2" BSP	1" BSP	Z11503216	96,36
2" BSP	1" 1/2 BSP	Z11503224	104,11

BSP fixed female plug

Tapón hembra hexagonal rosca BSP

Verschlussmutter fest BSP

Bouchon femelle gaz



ROSCA THREAD	Referencia Part n°	€
1/4" BSP	Z107204	12,96
3/8" BSP	Z107206	13,02
1/2" BSP	Z107208	13,87
3/4" BSP	Z107212	22,89
1" BSP	Z107216	28,06
1" 1/4 BSP	Z107220	48,72
1" 1/2 BSP	Z107224	63,02
2" BSP	Z107232	89,16

BSP male hexagonal plug

Tapón macho hexagonal rosca BSP 60°

Verschlusssschraube BSP

Bouchon mâle BSP cône 60°



ROSCA THREAD	Referencia Part n°	€
1/8" BSP	Z107002	12,29
1/4" BSP	Z107004	8,55
3/8" BSP	Z107006	10,02
1/2" BSP	Z107008	11,94
3/4" BSP	Z107012	15,93
1" BSP	Z107016	27,65
1" 1/4 BSP	Z107020	47,77
1" 1/2 BSP	Z107024	66,27
2" BSP	Z107032	77,64

BSP swivel female plug

Tapón hembra giratoria BSP cono 60°

Verschlussmutter BSP 60° kon.

Bouchon femelle tournante BSP cône 60°



ROSCA THREAD	Referencia Part n°	€
1/4" BSP	Z107504	9,14
3/8" BSP	Z107506	12,00
1/2" BSP	Z107508	13,94
3/4" BSP	Z107512	21,57
1" BSP	Z107516	31,83
1" 1/4 BSP	Z107520	54,32
1" 1/2 BSP	Z107524	81,06
2" BSP	Z107532	135,28

BSP Adaptors

Adaptadores BSP
Adapter BSP
Adapteurs BSP

Adaptor female fixed BSP - female fixed BSP

Manguito redondo roscado hembra BSP

Runde Hülse mit BSP-Innengewinde

Manchon femelle gaz ronde



ROSCA THREAD	Referencia Part n°	€
1/8" BSP	Z131002	7,66
1/4" BSP	Z131004	7,56
3/8" BSP	Z131006	11,34
1/2" BSP	Z131008	16,33
5/8" BSP	Z131010	24,93
3/4" BSP	Z131012	25,21
1" BSP	Z131016	29,80
1"1/4 BSP	Z131020	44,86
1"1/2 BSP	Z131024	58,76
2" BSP	Z131032	90,36

Adaptor hexagonal female fixed BSP - female fixed BSP

Manguito hexagonal roscado hembra BSP

Doppelmuffe IGR fest - IGR fest

Manchon femelle gaz - femelle gaz hexagone



ROSCA THREAD	Referencia Part n°	€
1/4" BSP	Z103104	6,86
3/8" BSP	Z103106	9,84
1/2" BSP	Z103108	18,14
3/4" BSP	Z103112	25,84
1" BSP	Z103116	41,11
1"1/4 BSP	Z103120	82,11
1"1/2 BSP	Z103124	93,01

Reducer hexagonal female fixed BSP - female fixed BSP

Manguito reducción hexagonal roscado hembra BSP

Reduziernippel IGR fest - IGR fest

Manchon réducteur femelle gaz - femelle gaz hexagone



ROSCA THREAD	Referencia Part n°	€
3/8" BSP	1/4" BSP Z10310604	18,46
1/2" BSP	1/4" BSP Z10310804	23,83
1/2" BSP	3/8" BSP Z10310806	25,31
3/4" BSP	1/2" BSP Z10311208	36,48
1" BSP	3/4" BSP Z10311612	76,99
1"1/4 BSP	1" BSP NEW Z10312016	85,27

Straight bulkhead adaptor BSP 60° without nut

Pasatabiques sin tuerca BSP cono 60°

Gerader Schottadapter DIN 3910 Form ohne M+S - GSA-X

Passe-cloison mâle BSP 60° - mâle BSP 60° sans équiper



ROSCA THREAD	Referencia Part n°	€
1/4" BSP	Z116004	17,02
3/8" BSP	Z116006	19,97
1/2" BSP	Z116008	26,83
3/4" BSP	Z116012	32,10
1" BSP	Z116016	55,48
1" 1/4 BSP	Z116020	87,82
1" 1/2 BSP	Z116024	119,23
2" BSP	Z116032	185,41

Conter nut for BSP bulkhead

Tuerca pasatabiques BSP

Gegenmuttern DIN 80705 für Schottverschraubungen - GM

Contre-écrou passe-cloison gaz



ROSCA THREAD	Referencia Part n°	€
1/4" BSP	Z116104	3,86
3/8" BSP	Z116106	5,17
1/2" BSP	Z116108	6,30
3/4" BSP	Z116112	9,38
1" BSP	Z116116	14,07
1" 1/4 BSP	Z116120	23,43
1" 1/2 BSP	Z116124	30,94
2" BSP	Z116132	39,95

BSP Adaptors

Adaptadores BSP
Adapter BSP
Adapteurs BSP

BSP Bolt for banjo

Tornillo orientable simple BSP

Einfache Hohlschraube BSP für Ringauge

Vis creuse simple pour banjo BSP



ROSCA THREAD	Referencia Part n°	€
1/8" BSP	Z109002	19,88
1/4" BSP	Z109004	14,76
3/8" BSP	Z109006	18,64
1/2" BSP	Z109008	21,93
3/4" BSP	Z109012	45,54
1" BSP	Z109016	58,60

Metric bolt for banjo

Tornillo orientable simple Métrico

Einfache Hohlschraube metr. für Ringauge

Vis creuse simple for banjo Métrique



ROSCA THREAD	Referencia Part n°	€
M12X1.5	Z109212	14,88
M14X1.5	Z109214	15,91
M16X1.5	Z109216	16,70
M18X1.5	Z109218	18,55
M22X1.5	Z109222	20,75
M26X1.5	Z109226	40,78
M30X2	Z109230	50,46

BSP Banjo-BSP male (60°)

Esférico BSP - macho BSP (60°)

Ringauge BSP-m BSP (60°)

Banjo passage gaz x mâle BSP (60°)



ROSCA THREAD	∅	Referencia Part n°	€
1/4" BSP	1/4"	Z114004	45,12
3/8" BSP	3/8"	Z114006	54,38
1/2" BSP	1/2"	Z114008	76,31
3/4" BSP	3/4"	Z114012	108,62
1" BSP	1"	Z114016	170,87

BSP Bonded Seal FKM Self-centering

Juntas metal FKM Gas Autocentrantes

USIT-Ringe FKM GAS Selbstzentrierend

Bague BS gaz FKM auto-centrée



ROSCA THREAD	Referencia Part n°	€
1/8" BSP	ZVT21002	1,30
1/4" BSP	ZVT21004	1,35
3/8" BSP	ZVT21006	1,64
1/2" BSP	ZVT21008	2,20
5/8" BSP	ZVT21010	4,11
3/4" BSP	ZVT21012	2,90
1" BSP	ZVT21016	5,30
1" 1/4 BSP	ZVT21020	8,47
1" 1/2 BSP	ZVT21024	10,33
2" BSP	ZVT21032	13,55
2" 1/2 BSP	ZVT21040	38,46

Metric Bonded Seal in FKM Self-centering

Juntas metal FKM Métricas Autocentrantes

USIT-Dichtringe FKM metr.Selbstzentrierend

Bague BS Métrique FKM auto-centrée



ROSCA THREAD	Referencia Part n°	€
M6X1	ZVT32006	0,63
M8X1	ZVT32008	1,54
M10X1	ZVT32010	1,96
M12X1,5	ZVT32012	1,46
M14X1,5	ZVT32014	1,91
M16X1,5	ZVT32016	2,08
M18X1,5	ZVT32018	2,20
M20X1,5	ZVT32020	3,27
M22X1,5	ZVT32022	2,88
M24X1,5	ZVT32024	6,11
M26X1,5	ZVT32026	5,33
M27X1,5	ZVT32027	5,61
M30X2	ZVT32030	9,31
M36X2	ZVT32036	11,60
M42X2	ZVT32042	13,98
M48X2	ZVT32048	17,21

BSP Adaptors

Adaptadores BSP

Adapter BSP

Adapteurs BSP

90° Elbow swivel female BSP 60° - male BSP 60°

Codo 90° macho - hembra giratoria BSP cono 60°

90° Winkel AGR-DKR

Adapteur coude 90° accesoriel mâle BSP - femelle tournante BSP cône 60°



ROSCA THREAD		Referencia Part n°	€
1/4" BSP	1/4" BSP	Z119404	47,93
3/8" BSP	3/8" BSP	Z119406	54,30
1/2" BSP	1/2" BSP	Z119408	58,81
3/4" BSP	3/4" BSP	Z119412	83,83
1" BSP	1" BSP	Z119416	105,23
1"1/4 BSP	1"1/4 BSP	Z119420	174,20
1"1/2 BSP	1"1/2 BSP	Z119424	223,21
2" BSP	2" BSP	Z119432	338,74

90° Elbow swivel female BSP 60° - swivel female BSP 60°

Codo 90° hembra giratoria - hembra giratoria BSP cono 60°

90° Winkel DKR-DKR

Adapteur coude 90° femelle tournante BSP - femelle tournante cône 60°



ROSCA THREAD		Referencia Part n°	€
1/4" BSP	1/4" BSP	ZA119604	32,61
3/8" BSP	3/8" BSP	ZA119606	42,76
1/2" BSP	1/2" BSP	ZA119608	49,57
3/4" BSP	3/4" BSP	ZA119612	61,36
1" BSP	1" BSP	ZA119616	94,83
1"1/4 BSP	1"1/4 BSP	ZA119620	159,54

45° Ebow swivel female BSP 60° - male BSP 60°

Codo 45° macho - hembra giratoria BSP cono 60°

45° Bogen AGR-DKR

Adapteur coude 45° accesoriel mâle BSP - femelle tournante BSP cône 60°



ROSCA THREAD		Referencia Part n°	€
1/4" BSP	1/4" BSP	Z119504	51,66
3/8" BSP	3/8" BSP	Z119506	54,30
1/2" BSP	1/2" BSP	Z119508	61,35
3/4" BSP	3/4" BSP	Z119512	82,32
1" BSP	1" BSP	Z119516	100,07
1"1/4 BSP	1"1/4 BSP	Z119520	189,12
1"1/2 BSP	1"1/2 BSP	Z119524	243,25
2" BSP	2" BSP	Z119532	415,17

45° Ebow swivel female BSP 60° - swivel female BSP 60°

Codo 45° hembra giratoria - hembra giratoria BSP cono 60°

45° Bogen DKR-DKR

Adapteur coude 45° femelle tournante BSP - femelle tournante BSP cône 60°



ROSCA THREAD		Referencia Part n°	€
1/4" BSP	1/4" BSP	ZA119504	40,55
3/8" BSP	3/8" BSP	ZA119506	44,53
1/2" BSP	1/2" BSP	ZA119508	52,10
3/4" BSP	3/4" BSP	ZA119512	67,18
1" BSP	1" BSP	ZA119516	93,83
1"1/4 BSP	1"1/4 BSP	ZA119520	220,46

BSP Adaptors

Adaptadores BSP

Adapter BSP

Adapteurs BSP

90° Adaptor male - male BSP 60°

Codo 90° macho - macho BSP cono 60°

90° Winkel BSP 90 X BSP 90

Adapteur coude 90° mâle BSP - mâle BSP cône 60° forge



ROSCA THREAD		Referencia Part n°	€
1/8" BSP	1/8" BSP	Z1190002	28,05
1/4" BSP	1/4" BSP	Z1190004	25,30
3/8" BSP	3/8" BSP	Z1190006	29,03
1/2" BSP	1/2" BSP	Z1190008	38,84
3/4" BSP	3/4" BSP	Z1190012	53,45
1" BSP	1" BSP	Z1190016	79,39
1"1/4 BSP	1"1/4 BSP	Z1190020	152,74
1"1/2 BSP	1"1/2 BSP	Z1190024	162,69

90° Adaptor male BSP 60° - male BSPT

Codo 90° macho BSP 60° - macho BSPT

90° Winkel AGR-AG BSPT

Adapteur coude 90° mâle BSP cône 60° - mâle gaz conique BSPT forge



ROSCA THREAD		Referencia Part n°	€
1/8" BSP	1/8" BSPT	Z119202	27,57
1/4" BSP	1/4" BSPT	Z119204	20,96
3/8" BSP	3/8" BSPT	Z119206	29,58
1/2" BSP	1/2" BSPT	Z119208	37,68
3/4" BSP	3/4" BSPT	Z119212	53,55
1" BSP	1" BSPT	Z119216	78,30
1"1/4 BSP	1"1/4 BSPT	Z119220	135,65
1"1/2 BSP	1"1/2 BSPT	Z119224	187,36

90° Adjustable stud elbow male-male BSP

Codo 90° regulable macho - macho BSP

90° Winkel einstellbar m - m BSP

Coude 90° orientable mâle - mâle BSP



ROSCA THREAD		Referencia Part n°	€
1/4" BSP	1/4" BSP	Z119704	25,14
3/8" BSP	3/8" BSP	Z119706	36,31
1/2" BSP	1/2" BSP	Z119708	71,19
3/4" BSP	3/4" BSP	Z119712	98,58
1" BSP	1" BSP	Z119716	158,93

90° Adaptor male BSP 60° - male NPT

Codo 90° macho BSP 60° - macho NPT

90° Winkel AGR-AGN

Adapteur coude 90° mâle BSP 60° - mâle NPT forge



ROSCA THREAD		Referencia Part n°	€
1/4" BSP	1/4" NPT	Z11910404	22,60
3/8" BSP	3/8" NPT	Z11910606	31,96
1/2" BSP	1/2" NPT	Z11910808	33,42
3/4" BSP	3/4" NPT	Z11911212	56,48
1" BSP	1" NPT	Z11911616	71,48

90° Adaptor male - swivel female BSP 60°

Codo 90° macho - hembra giratoria BSP cono 60°

90° Winkel m - w BSP (60°) kon.

Adapteur coude 90° mâle BSP - femelle tournante BSP cône 60° forge



ROSCA THREAD		Referencia Part n°	€
1/8" BSP	1/8" BSP	Z119302	30,30
1/4" BSP	1/4" BSP	Z119304	25,43
3/8" BSP	3/8" BSP	Z119306	35,40
1/2" BSP	1/2" BSP	Z119308	44,50
3/4" BSP	3/4" BSP	Z119312	58,97
1" BSP	1" BSP	Z119316	89,90
1"1/4 BSP	1"1/4 BSP	Z119320	154,41
1"1/2 BSP	1"1/2 BSP	Z119324	184,32

90° Adaptor fixed female BSP

Codo 90° hembra fija - hembra fija BSP

90° Winkel w fest BSP

Adapteur coude 90° femelle fixe gaz cylindrique forge



ROSCA THREAD		Referencia Part n°	€
1/8" BSP	1/8" BSP	Z119602	22,99
1/4" BSP	1/4" BSP	Z119604	28,78
3/8" BSP	3/8" BSP	Z119606	39,77
1/2" BSP	1/2" BSP	Z119608	45,78
3/4" BSP	3/4" BSP	Z119612	68,73
1" BSP	1" BSP	Z119616	91,71

90° Adaptor swivel female BSP 60°

Codo 90° hembra giratoria - hembra giratoria BSP cono 60°

90° Winkel w mit Ü-Mutter - w mit Ü-Mutter BSP (60°) kon.

Adapteur coude 90° femelle tournante BSP cône 60° forge



ROSCA THREAD		Referencia Part n°	€
1/4" BSP	1/4" BSP	Z119804	33,59
3/8" BSP	3/8" BSP	Z119806	40,09
1/2" BSP	1/2" BSP	Z119808	49,21
3/4" BSP	3/4" BSP	Z119812	65,68
1" BSP	1" BSP	Z119816	124,73
1"1/4 BSP	1"1/4 BSP	Z119820	227,60
1"1/2 BSP	1"1/2 BSP	Z119824	368,12

45° Adaptor male - swivel female BSP 60°

Codo 45° macho - hembra giratoria BSP cono 60°

45° Winkel m - w Ü-Mutter BSP 60°

Adapteur coude 45° mâle BSP - femelle tournante BSP cône 60° forge



ROSCA THREAD		Referencia Part n°	€
1/4" BSP	1/4" BSP	Z118304	37,20
3/8" BSP	3/8" BSP	Z118306	47,39
1/2" BSP	1/2" BSP	Z118308	61,99
3/4" BSP	3/4" BSP	Z118312	96,08
1" BSP	1" BSP	Z118316	145,78

BSP Adaptors

Adaptadores BSP
Adapter BSP
Adapteurs BSP

Tees BSP 60° male

Tes macho - macho - macho BSP cono 60°

T-Stück AGR

Adapteurs Té mâle BSP cône 60° forge



ROSCA THREAD			Referencia Part n°	€
1/4" BSP	1/4" BSP	1/4" BSP	Z122004	30,61
3/8" BSP	3/8" BSP	3/8" BSP	Z122006	38,58
1/2" BSP	1/2" BSP	1/2" BSP	Z122008	44,99
3/4" BSP	3/4" BSP	3/4" BSP	Z122012	53,95
1" BSP	1" BSP	1" BSP	Z122016	112,44
1"1/4 BSP	1"1/4 BSP	1"1/4 BSP	Z122020	197,02
1"1/2 BSP	1"1/2 BSP	1"1/2 BSP	Z122024	284,20

Tees BSP 60° male - male - swivel female

Tes macho - macho - hembra giratoria BSP 60°

T-Stück AGR-AGR-DKR

Adapteurs Té mâle BSP - mâle BSP - femelle tournante BSP cône 60° forge



ROSCA (M) THREAD (M)	ROSCA (H) THREAD (F)	Referencia Part n°	€
1/4" BSP	1/4" BSP	Z122204	35,95
3/8" BSP	3/8" BSP	Z122206	44,74
1/2" BSP	1/2" BSP	Z122208	51,71
3/4" BSP	3/4" BSP	Z122212	92,62
1" BSP	1" BSP	Z122216	164,22
1"1/4 BSP	1"1/4 BSP	Z122220	238,71
1"1/2 BSP	1"1/2 BSP	Z122224	349,29

Tees BSP 60° male - swivel female - male

Tes macho - hembra giratoria - macho BSP 60°

T-Stück AGR-DKR-AGR

Adapteurs Té mâle BSP - femelle tournante - mâle BSP cône 60° forge



ROSCA (M) THREAD (M)	ROSCA (H) THREAD (F)	ROSCA (M) THREAD (M)	Referencia Part n°	€
1/4" BSP	1/4" BSP	1/4" BSP	Z122404	36,90
3/8" BSP	3/8" BSP	3/8" BSP	Z122406	47,36
1/2" BSP	1/2" BSP	1/2" BSP	Z122408	62,43
3/4" BSP	3/4" BSP	3/4" BSP	Z122412	99,74
1" BSP	1" BSP	1" BSP	Z122416	163,68
1"1/4 BSP	1"1/4 BSP	1"1/4 BSP	Z122420	219,46
1"1/2 BSP	1"1/2 BSP	1"1/2 BSP	Z122424	295,06

Tees BSP 60° swivel female

Tes hembras giratorias BSP cono 60°

T-Stücke DKR

Adapteurs Té femelle tournante BSP cône 60° forge



ROSCA THREAD			Referencia Part n°	€
1/4" BSP	1/4" BSP	1/4" BSP	Z122804	46,09
3/8" BSP	3/8" BSP	3/8" BSP	Z122806	53,46
1/2" BSP	1/2" BSP	1/2" BSP	Z122808	66,49
3/4" BSP	3/4" BSP	3/4" BSP	Z122812	116,25
1" BSP	1" BSP	1" BSP	Z122816	139,85
1"1/4 BSP	1"1/4 BSP	1"1/4 BSP	Z122820	278,72
1"1/2 BSP	1"1/2 BSP	1"1/2 BSP	Z122824	369,20

Tees fixed female BSP

Tes hembras fijas BSP

T-BSP IGR fest

Adapteurs Té femelle gaz forge



ROSCA THREAD			Referencia Part n°	€
1/4" BSP	1/4" BSP	1/4" BSP	Z122604	34,58
3/8" BSP	3/8" BSP	3/8" BSP	Z122606	46,64
1/2" BSP	1/2" BSP	1/2" BSP	Z122608	54,83
3/4" BSP	3/4" BSP	3/4" BSP	Z122612	82,09
1" BSP	1" BSP	1" BSP	Z122616	123,92

Tees BSP 60° male - NPT male center - BSP 60° male

Tes macho BSP 60° - macho NPT central - macho BSP 60°

T-Verschraubungen m BSP 60° - m NPT zentral - m BSP 60°

Adapteurs Té mâle BSP 60° - mâle NPT central - mâle BSP 60° forge



ROSCA THREAD			Referencia Part n°	€
1/4" BSP	1/4" NPT	1/4" BSP	Z12210404	34,44
3/8" BSP	3/8" NPT	3/8" BSP	Z12210606	46,54
1/2" BSP	1/2" NPT	1/2" BSP	Z12210808	71,42
3/4" BSP	3/4" NPT	3/4" BSP	Z12211212	79,85
1" BSP	1" NPT	1" BSP	Z12211616	118,82

Tees BSP 60° male - BSP 60° male - NPT lateral male

Tes macho BSP 60° - macho BSP 60° - macho NPT lateral

T-Verschraubungen m BSP 60° - m BSP 60° - m NPT seitl.

Adapteurs Té mâle BSP 60° - mâle BSP 60° - mâle NPT latéral forge



ROSCA THREAD			Referencia Part n°	€
1/4" BSP	1/4" BSP	1/4" NPT	Z12230404	37,56
3/8" BSP	3/8" BSP	3/8" NPT	Z12230606	46,54
1/2" BSP	1/2" BSP	1/2" NPT	Z12230808	75,16
3/4" BSP	3/4" BSP	3/4" NPT	Z12231212	80,82
1" BSP	1" BSP	1" NPT	Z12231616	118,82

Cross fixed female BSP

Cruz hembra fija BSP

Kreuzstück BSP Innengewinde

Croix BSP femelle fixe



ROSCA THREAD	Referencia Part n°	€
1/4" BSP	Z122704	44,61
3/8" BSP	Z122706	63,73
1/2" BSP	Z122708	79,92
3/4" BSP	Z122712	121,09
1" BSP	Z122716	154,74

NPT Adaptors

Adaptadores NPT
Adapter NPT
Adapteurs NPT

Adaptor male NPT - male NPT

Adaptor macho - macho NPT

Doppelnippel AGN-AGN

Adapteur mâle NPT - mâle NPT



ROSCA THREAD	ROSCA (H) THREAD (F)	Referencia Part n°	€
1/4" NPT	1/4" NPT	ZN10150404	9,20
3/8" NPT	3/8" NPT	ZN10150606	13,00
1/2" NPT	1/2" NPT	ZN10150808	14,68
3/4" NPT	3/4" NPT	ZN10151212	19,03
1" NPT	1" NPT	ZN10151616	39,99
1" 1/4 NPT	1" 1/4 NPT	ZN10152020	58,47
1" 1/2 NPT	1" 1/2 NPT	ZN10152424	70,67
2" NPT	2" NPT	ZN10153232	122,10

Reducer male NPT - male NPT

Reductor macho - macho NPT

Reduziernippel NPT

Réducteur mâle NPT - mâle NPT



ROSCA THREAD	ROSCA (H) THREAD (F)	Referencia Part n°	€
1/4" NPT	1/8" NPT	ZN10150402	10,81
3/8" NPT	1/8" NPT	ZN10150602	14,07
3/8" NPT	1/4" NPT	ZN10150604	16,50
1/2" NPT	1/4" NPT	ZN10150804	18,65
1/2" NPT	3/8" NPT	ZN10150806	22,99
3/4" NPT	3/8" NPT	ZN10151206	26,57
3/4" NPT	1/2" NPT	ZN10151208	23,08
1" NPT	1/2" NPT	ZN10151608	34,37
1" NPT	3/4" NPT	ZN10151612	35,02
1" 1/4 NPT	1" NPT	ZN10152016	60,16
1" 1/2 NPT	1" NPT	ZN10152416	81,82
1" 1/2 NPT	1" 1/4 NPT	ZN10152420	86,96

Adaptor male NPT - fixed female NPT

Adaptador macho - hembra fija NPT

Adapter m - w fest NPT

Adapteur mâle NPT - femelle fixe NPT



ROSCA (M) THREAD (M)	ROSCA (H) THREAD (F)	Referencia Part n°	€
1/8" NPT	1/8" NPT	ZN10600202	17,24
1/8" NPT	1/4" NPT	ZN10600204	21,37
1/4" NPT	1/8" NPT	ZN10600402	17,04
1/4" NPT	1/4" NPT	ZN10600404	13,84
1/4" NPT	3/8" NPT	ZN10600406	19,29
1/4" NPT	1/2" NPT	ZN10600408	30,96
3/8" NPT	1/4" NPT	ZN10600604	20,66
3/8" NPT	3/8" NPT	ZN10600606	17,92
3/8" NPT	1/2" NPT	ZN10600608	21,68
1/2" NPT	3/8" NPT	ZN10600806	21,24
1/2" NPT	1/2" NPT	ZN10600808	28,99
1/2" NPT	3/4" NPT	ZN10600812	34,36
3/4" NPT	1/2" NPT	ZN10601208	31,56
3/4" NPT	3/4" NPT	ZN10601212	33,05
3/4" NPT	1" NPT	ZN10601216	44,17
1" NPT	3/4" NPT	ZN10601612	44,14
1" NPT	1" NPT	ZN10601616	50,70

Reducer male NPT - fixed female NPT

Reductor macho - hembra fija NPT

Reduzierstück m - w fest NPT

Réducteur mâle NPT - femelle fixe NPT



ROSCA (M) THREAD (M)	ROSCA (H) THREAD (F)	Referencia Part n°	€
3/8" NPT	1/8" NPT	ZN11500602	24,83
3/8" NPT	1/4" NPT	ZN11500604	21,29
1/2" NPT	1/4" NPT	ZN11500804	28,99
1/2" NPT	3/8" NPT	ZN11500806	24,38
3/4" NPT	1/4" NPT	ZN11501204	39,40
3/4" NPT	3/8" NPT	ZN11501206	39,70
3/4" NPT	1/2" NPT	ZN11501208	37,71
1" NPT	3/8" NPT	ZN11501606	52,25
1" NPT	1/2" NPT	ZN11501608	53,69
1" NPT	3/4" NPT	ZN11501612	51,13
1" 1/4 NPT	1" NPT	ZN11502016	84,49
1" 1/2 NPT	1" NPT	ZN11502416	152,01
1" 1/2 NPT	1" 1/4 NPT	ZN11502420	114,33

Adaptor male NPT - swivel female NPSM

Adaptador macho NPT - hembra giratoria NPSM

Adapter m NPT - w mit Drallmutter NPSM

Adapteur mâle NPT - femelle tournante NPSM



ROSCA (M) THREAD (M)	ROSCA (H) THREAD (F)	Referencia Part n°	€
1/8" NPT	1/8" NPSM	ZN11700202	18,67
1/4" NPT	1/4" NPSM	ZN11700404	20,47
3/8" NPT	3/8" NPSM	ZN11700606	26,14
3/8" NPT	1/2" NPSM	ZN11700608	36,34
1/2" NPT	1/2" NPSM	ZN11700808	46,87
1/2" NPT	3/4" NPSM	ZN11700812	51,39
3/4" NPT	3/4" NPSM	ZN11701212	50,40
3/4" NPT	1" NPSM	ZN11701216	76,72
1" NPT	1" NPSM	ZN11701616	78,92
1" 1/4 NPT	1" 1/4 NPSM	ZN11702020	110,33
1" 1/2 NPT	1" 1/2 NPSM	ZN11702424	129,87

Adaptor male UNF - swivel female NPSM

Adaptador macho UNF - hembra giratoria NPSM

Adapter m UNF - w mit Drallmutter NPSM

Adapteur mâle UNF - femelle tournante NPSM



ROSCA THREAD	ROSCA (H) THREAD (F)	Referencia Part n°	€
7/16" 20h UNF	1/4" 18h NPSM	ZN11740404	24,73
9/16" 18h UNF	3/8" 18h NPSM	ZN11740606	30,65
9/16" 18h UNF	1/2" 14h NPSM	ZN11740608	46,53
3/4" 16h UNF	1/2" 14h NPSM	ZN11740808	42,30
3/4" 16h UNF	3/4" 14h NPSM	ZN11740812	58,96
7/8" 14h UNF	1/2" 14h NPSM	ZN11741008	56,82
7/8" 14h UNF	3/4" 14h NPSM	ZN11741012	57,89
1" 11/16 12h UNF	3/4" 14h NPSM	ZN11741212	53,60
1" 5/16 12h UNF	1" 11 1/2h NPSM	ZN11741616	95,02
1" 5/8 12h UNF	1" 1/4 11-1/2h NPSM	ZN11742020	153,77

NPT Adaptors

Adaptadores NPT
Adapter NPT
Adpteurs NPT

S.S. NPT fixed cap

Tapón hembra fija NPT

S.S. Verschlussstopfen HF NPT

Bouchon femelle fixe NPT



ROSCA THREAD	Referencia Part n°	€
1/8" NPT	ZN107202	12,05
1/4" NPT	ZN107204	14,28
3/8" NPT	ZN107206	16,87
1/2" NPT	ZN107208	19,98
3/4" NPT	ZN107212	25,74
1" NPT	ZN107216	34,34

S.S. NPT male plug

Tapón macho NPT

S.S. Verschluss TYP NPT

Bouchon mâle NPT



ROSCA THREAD	Referencia Part n°	€
1/8" NPT	ZN107002	5,21
1/4" NPT	ZN107004	7,66
3/8" NPT	ZN107006	10,40
1/2" NPT	ZN107008	12,87
3/4" NPT	ZN107012	13,31
1" NPT	ZN107016	24,53
1"1/4 NPT	ZN107020	49,95
1"1/2 NPT	ZN107024	80,11

S.S. NPT Allen plug

Tapón Allen NPT

S.S. Verschlussversch. Innensechskant NPT

Bouchon Allen NPT



ROSCA THREAD	Referencia Part n°	€
1/4" NPT	ZN107104	7,44
3/8" NPT	ZN107106	10,09
1/2" NPT	ZN107108	11,18
3/4" NPT	ZN107112	12,51
1" NPT	ZN107116	22,21

NPT hexagonal adaptor fixed female

Adaptador hexagonal hembra fija NPT

6 kt Doppelmuffe fest NPT

Adapteur hexagonal femelle fixe NPT

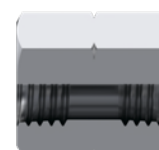

ROSCA THREAD	ROSCA THREAD	Referencia Part n°	€
1/8" NPT	1/8" NPT	ZN10310202	10,47
1/4" NPT	1/4" NPT	ZN10310404	12,22
3/8" NPT	3/8" NPT	ZN10310606	13,58
1/2" NPT	1/2" NPT	ZN10310808	19,32
3/4" NPT	3/4" NPT	ZN10311212	26,54
1" NPT	1" NPT	ZN10311616	44,38
1" 1/4 NPT	1" 1/4 NPT	ZN10312020	54,90

NPT Adaptors

Adaptadores NPT

Adapter NPT

Adapteurs NPT

90° elbow male NPT - male NPT

Codo 90° macho - macho NPT

90° Winkel m-m NPT

Coude 90° mâle NPT - mâle NPT



ROSCA THREAD		Referencia Part n°	€
1/8" NPT	1/8" NPT	ZN119002	22,14
1/4" NPT	1/4" NPT	ZN119004	24,20
3/8" NPT	3/8" NPT	ZN119006	35,34
1/2" NPT	1/2" NPT	ZN119008	40,07
3/4" NPT	3/4" NPT	ZN119012	61,71
1" NPT	1" NPT	ZN119016	93,28
1" 1/4 NPT	1" 1/4 NPT	ZN119020	151,40

90° elbow male NPT - swivel female NPSM

Codo 90° macho NPT - hembra giratoria NPSM

90° Winkel m NPT - w mit Ü-Mutter NPSM

Coude 90° mâle NPT - femelle tournante NPSM



ROSCA THREAD		Referencia Part n°	€
1/8" NPT	1/8" 27h NPSM	ZN11930202	31,87
1/4" NPT	1/4" - 18h NPSM	ZN11930404	35,26
1/4" NPT	3/8" - 18h NPSM	ZN11930406	77,82
3/8" NPT	3/8" - 18h NPSM	ZN11930606	44,69
3/8" NPT	1/2" - 14h NPSM	ZN11930608	79,34
1/2" NPT	1/2" - 14 NPSM	ZN11930808	55,40
1/2" NPT	3/4" - 14h NPSM	ZN11930812	108,54
3/4" NPT	1/2" - 14 NPSM	ZN11931208	105,51
3/4" NPT	3/4" - 14h NPSM	ZN11931212	65,94
3/4" NPT	1" - 11 1/2 h NPSM	ZN11931216	207,39
1" NPT	1" - 11 1/2 h NPSM	ZN11931616	84,98
1" 1/4 NPT	1" 1/4 - 11 1/2 h NPSM	ZN11932020	159,61

90° elbow fixed female NPT - fixed female NPT

Codo 90° hembra fija - hembra fija NPT

90° Winkel w fest - w fest NPT

Coude 90° femelle fixe NPT - femelle fixe NPT



ROSCA THREAD		Referencia Part n°	€
1/8" NPT	1/8" NPT	ZN11960202	23,02
1/4" NPT	1/4" NPT	ZN11960404	33,69
3/8" NPT	3/8" NPT	ZN11960606	37,49
1/2" NPT	1/2" NPT	ZN11960808	45,22
3/4" NPT	3/4" NPT	ZN11961212	73,25
1" NPT	1" NPT	ZN11961616	100,93

45° elbow male NPT - male NPT

Codo 45° macho - macho NPT

45° Winkel m-m NPT

Coude 45° mâle NPT - mâle NPT



ROSCA THREAD		Referencia Part n°	€
1/4" NPT	1/4" NPT	ZN119804	20,02
3/8" NPT	3/8" NPT	ZN119806	27,43
1/2" NPT	1/2" NPT	ZN119808	42,21
3/4" NPT	3/4" NPT	ZN119812	58,15
1" NPT	1" NPT	ZN119816	80,36

45° elbow fixed female NPT - fixed female NPT

Codo 45° hembra fija - hembra fija NPT

45° Bogen w fest - w fest NPT

Coude 45° femelle fixe NPT - femelle fixe NPT



ROSCA THREAD		Referencia Part n°	€
1/4" NPT	1/4" NPT	ZN139604	26,01
3/8" NPT	3/8" NPT	ZN139606	42,80
1/2" NPT	1/2" NPT	ZN139608	51,63
3/4" NPT	3/4" NPT	ZN139612	81,78
1" NPT	1" NPT	ZN139616	136,79

45° elbow male NPT - swivel female NPSM

Codo 45° macho NPT - hembra giratoria NPSM

45° Bogen m NPT - w NPSM

Coude 45° mâle NPT - swivel female NPSM



ROSCA THREAD		Referencia Part n°	€
1/4" NPT	1/4" - 18h NPSM	ZN139304	66,99
3/8" NPT	3/8" - 18h NPSM	ZN139306	70,16
1/2" NPT	1/2" - 14h NPSM	ZN139308	86,60
3/4" NPT	3/4" - 14h NPSM	ZN139312	118,60
1" NPT	1" - 11 1/2 h NPSM	ZN139316	219,77

NPT Adaptors

Adaptadores NPT

Adapter NPT

Adapteurs NPT

NPT male tee

Tes macho-macho-macho NPT

T-Verschraubungen m - m - m NPT

Té mâle NPT



ROSCA THREAD			Referencia Part n°	€
1/8" NPT	1/8" NPT	1/8" NPT	ZN122002	27,55
1/4" NPT	1/4" NPT	1/4" NPT	ZN122004	38,77
3/8" NPT	3/8" NPT	3/8" NPT	ZN122006	44,14
1/2" NPT	1/2" NPT	1/2" NPT	ZN122008	49,12
3/4" NPT	3/4" NPT	3/4" NPT	ZN122012	82,72
1" NPT	1" NPT	1" NPT	ZN122016	158,65

NPT fixed female tee

Tes hembra fija-hembra fija-hembra fija NPT

T-Verschraubungen w fest NPT

Té femelle fixe NPT



ROSCA THREAD			Referencia Part n°	€
1/8" NPT	1/8" NPT	1/8" NPT	ZN122602	27,79
1/4" NPT	1/4" NPT	1/4" NPT	ZN122604	35,05
3/8" NPT	3/8" NPT	3/8" NPT	ZN122606	46,63
1/2" NPT	1/2" NPT	1/2" NPT	ZN122608	65,52
3/4" NPT	3/4" NPT	3/4" NPT	ZN122612	91,10
1" NPT	1" NPT	1" NPT	ZN122616	111,43

SI NO HAS ENCONTRADO
LO QUE BUSCAS, HABLEMOS.

**SOMOS FABRICANTES
WE ARE MANUFACTURERS**

IF YOU HAVE NOT FOUND
WHAT YOU ARE LOOKING FOR, LET'S TALK.



DICSA

#HYDRAULICSEXPERTS

O'Ring Boss Adaptors

Adaptadores O'Ring Boss

Adapter O'Ring Boss

Adapteurs O'Ring Boss

Adaptor male - male O'Ring Boss

Adaptador macho - macho O'Ring Boss

Doppelnippel m - M O'Ring Boss

Adapteur mâle - mâle O'Ring Boss



TUBO PIPE	ROSCA THREAD	Referencia Part n°	€
6	1/4" 7/16"-20h UNF	ZS64640606	10,93
8	5/16" 1/2"-20h UNF	ZS64640808	11,07
10	3/8" 9/16"-18h UNF	ZS64641010	12,28
12	1/2" 3/4"-16h UNF	ZS64641212	17,91
14-15-16	5/8" 7/8"-14h UNF	ZS64641616	19,36
18-20	3/4" 1"1/16-12h UN	ZS64642020	27,40
25	1" 1"5/16-12h UN	ZS64642525	32,94

Adaptor male O'Ring Boss - male JIC 37°

Adaptador macho O'Ring Boss - macho JIC 37°

Doppelnippel m O'Ring Boss - m JIC 37°

Adapteur mâle O'Ring Boss- mâle JIC 37°



TUBO PIPE	ROSCA THREAD	Referencia Part n°	€
6	1/4" 7/16"-20h UNF	ZS22006	14,53
8	5/16" 1/2"-20h UNF	ZS22008	15,72
10	3/8" 9/16"-18h UNF	ZS22010	16,38
12	1/2" 3/4"-16h UNF	ZS22012	20,00
14-15-16	5/8" 7/8"-14h UNF	ZS22016	22,73
18-20	3/4" 1"1/16-12h UN	ZS22020	31,65
25	1" 1"5/16-12h UN	ZS22025	52,68
30-32	1"1/4 1"5/8-12h UN	ZS22032	86,25
38	1"1/2 1"7/8-12h UN	ZS22038	111,33

Adaptor male O'Ring Boss - adjustable male O'Ring Boss

Adaptador macho O'Ring Boss - macho regulable O'Ring Boss

Doppelnippel m O'Ring Boss - m einstellbar O'Ring Boss

Adapteur mâle O'Ring Boss - mâle réglable O'Ring Boss

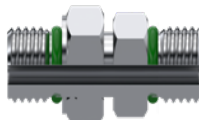

TUBO PIPE	ROSCA THREAD	Referencia Part n°	€
6	1/4" 7/16"-20h UNF	ZS34740606	25,31
10	3/8" 9/16"-18h UNF	ZS34741010	35,09
12	1/2" 3/4"-16h UNF	ZS34741212	44,19
14-15-16	5/8" 7/8"-14h UNF	ZS34741616	56,66
18-20	3/4" 1"1/16-12h UN	ZS34742020	103,69
25	1" 1"5/16-12h UN	ZS34742525	143,75

Adaptor male O'Ring Boss - male NPT

Adaptador macho O'Ring Boss - macho NPT

Doppelnippel m O'Ring Boss - m NPT

Adapteur mâle O'Ring Boss- mâle NPT

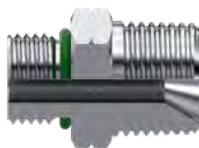

TUBO PIPE	ROSCA THREAD	Referencia Part n°	€
6	1/4" 7/16"-20h UNF	ZS64010613	12,02
10	3/8" 9/16"-18h UNF	ZS64011017	18,01
12	1/2" 3/4"-16h UNF	ZS64011221	19,66
14-15-16	5/8" 7/8"-14h UNF	ZS64011621	25,10
18-20	3/4" 1"1/16-12h UN	ZS64012026	33,33
25	1" 1"5/16-12h UN	ZS64012533	40,39

Adaptor male O'Ring Boss - swivel female JIC 37°

Adaptador macho O'Ring Boss - hembra giratoria JIC 37°

Adapter m O'Ring Boss - w mit Ü-Mutter metr. JIC 37°

Adapteur mâle O'Ring Boss - femelle tournante JIC 37°



TUBO PIPE	ROSCA (H) THREAD (F)	ROSCA (M) THREAD (M)	Referencia Part n°	€
6	1/4" 7/16" 20h UNF	7/16" 20h UNF	ZS38006	19,44
10	3/8" 9/16" 18h UNF	9/16" 18h UNF	ZS38010	24,61
12	1/2" 3/4" 16h UNF	3/4" 16h UNF	ZS38012	27,16
14-15-16	5/8" 7/8" 14h UNF	7/8" 14h UNF	ZS38016	29,94
18-20	3/4" 1"1/16 12h UN	1"1/16 12h UN	ZS38020	40,03
25	1" 1"5/16 12h UN	1"5/16 12h UN	ZS38025	62,23

Adaptor male O'Ring Boss - fixed female NPT

Prolongador macho O'Ring Boss - hembra fija NPT

Adapter m O'Ring Boss - w fest NPT

Prolongateur mâle O'Ring Boss - femelle fixe NPT



TUBO PIPE	ROSCA THREAD	Referencia Part n°	€
6	1/4" 7/16"-20h UNF	ZS64050613	23,66
10	3/8" 9/16"-18h UNF	ZS64051017	22,26
12	1/2" 3/4"-16h UNF	ZS64051221	38,11
14-15-16	5/8" 7/8"-14h UNF	ZS64051621	39,49
18-20	3/4" 1"1/16-12h UN	ZS64052026	55,51
25	1" 1"5/16-12h UN	ZS64052533	71,27

Male hexagonal O'Ring Boss plug

Tapón macho O'Ring Boss hexagonal

Verschlusssschraube TYP O'Ring Boss 6 kt

Bouchon mâle O'Ring Boss hexagonal



ROSCA THREAD	Referencia Part n°	€
7/16"-20h UNF	ZS640806	14,29
1/2"-20h UNF	ZS640808	10,79
9/16"-18h UNF	ZS640810	14,64
3/4"-16h UNF	ZS640812	15,64
7/8"-14h UNF	ZS640816	15,96
1"1/16-12h UN	ZS640820	21,97
1"5/16-12h UN	ZS640825	30,71

Male allen O'Ring Boss plug

Tapón macho O'Ring Boss Allen

Verschlusssschraube TYP O'Ring Boss Innensechskant

Bouchon mâle O'Ring Boss allen



ROSCA THREAD	Referencia Part n°	€
7/16"-20h UNF	ZS640906	13,05
1/2"-20h UNF	ZS640908	18,54
9/16"-18h UNF	ZS640910	19,03
3/4"-16h UNF	ZS640912	21,94
7/8"-14h UNF	ZS640916	22,73
1"1/16-12h UN	ZS640920	33,38
1"5/16-12h UN	ZS640925	50,12

O'Ring Boss Adaptors

Adaptadores O'Ring Boss

Adapter O'Ring Boss

Adapteurs O'Ring Boss

90° Adjustable elbow male O'Ring Boss - male JIC 37°

Codo 90° regulable macho O'Ring Boss - macho JIC 37°

90° Winkel einstellbar m O'Ring Boss - m JIC 37°

Coude 90° orientable mâle O'Ring Boss - mâle JIC 37°



TUBO PIPE	ROSCA THREAD		Referencia Part n°	€
6	1/4"	7/16"-20h UNF	ZS57506	23,43
8	5/16"	1/2"-20h UNF	ZS57508	25,93
10	3/8"	9/16"-18h UNF	ZS57510	28,95
12	1/2"	3/4"-16h UNF	ZS57512	47,34
14-15-16	5/8"	7/8"-14h UNF	ZS57516	61,30
18-20	3/4"	1"1/16-12h UN	ZS57520	90,10
25	1"	1"5/16-12h UN	ZS57525	123,65

Adjustable Tee male O'Ring Boss - male JIC 37° - male JIC 37°

Te regulable macho O'Ring Boss - macho JIC 37° - macho JIC 37°

Einstellbare T-Einschraubungen O'Ring Boss - m JIC 37° - m JIC 37°

Té orientable macho O'Ring Boss - macho JIC 37° - macho JIC 37°



TUBO PIPE	ROSCA THREAD		Referencia Part n°	€
6	1/4"	7/16" - 20h UNF	ZS680306	48,76
8	5/16"	1/2" - 20h UNF	ZS680308	59,48
10	3/8"	9/16" - 18h UNF	ZS680310	64,65
12	1/2"	3/4" - 16h UNF	ZS680312	78,08
14-15-16	5/8"	7/8" 14h UNF	ZS680316	97,81
18-20	3/4"	1"1/16-12h UN	ZS680320	121,51
25	1"	1"5/16-12h UN	ZS680325	165,14

Adjustable Tee male JIC 37° - male O'Ring Boss - male JIC 37°

Te regulable macho JIC 37° - macho O'Ring Boss - macho JIC 37°

Einstellbare T-Einschraubungen m JIC 37° - O'Ring Boss - m JIC 37°

Té orientable macho JIC 37° - macho O'Ring Boss - macho JIC 37°



TUBO PIPE	ROSCA THREAD		Referencia Part n°	€
6	1/4"	7/16" - 20h UNF	ZS680406	48,76
8	5/16"	1/2"-20h UNF	ZS680408	59,48
10	3/8"	9/16" - 18h UNF	ZS680410	64,65
12	1/2"	3/4" - 16h UNF	ZS680412	78,08
14-15-16	5/8"	7/8" 14h UNF	ZS680416	97,81
18-20	3/4"	1"1/16-12h UN	ZS680420	121,51
25	1"	1"5/16-12h UN	ZS680425	165,14

ORFS Adaptors

Adaptadores ORFS
Adapter ORFS
Adapteurs ORFS

ORFS Nut

Tuerca ORFS

Mutter ORFS - m ORFS

Écrou ORFS



TUBO PIPE	ROSCA THREAD	Referencia Part n°	€
6-8	ORFS 9/16"-18h	ZOR1020400	10,88
10	ORFS 11/16"-16h	ZOR1020600	12,31
12	ORFS 13/16"-16h	ZOR1020800	13,21
14-15-16	ORFS 1"-14h	ZOR1021000	21,42
18-20	ORFS 1"3/16-12h	ZOR1021200	23,04
22-25	ORFS 1"7/16-12h	ZOR1021600	30,01
28-30-32	ORFS 1"11/16-12h	ZOR1022000	45,13
35-38	ORFS 2"-12h	ZOR1022400	55,82

ORFS Welding nipple

Cono soldar ORFS

Schweißkegel ORFS

Collet à souder ORFS



TUBO PIPE	ROSCA THREAD	Referencia Part n°	€
6	ORFS 9/16"-18h	ZOR12730406	9,03
8	ORFS 9/16"-18h	ZOR12730408	9,86
10	ORFS 11/16"-16h	ZOR12730610	9,02
12	ORFS 13/16"16h	ZOR12730812	10,73
14	ORFS 1"-14h	ZOR12731014	16,65
15	ORFS 1"-14h	ZOR12731015	13,54
16	ORFS 1"-14h	ZOR12731016	13,77
18	ORFS 1" 3/16-12h	ZOR12731218	20,73
20	ORFS 1" 3/16-12h	ZOR12731220	20,73
22	ORFS 1" 7/16-12h	ZOR12731622	29,36
30	ORFS 1"11/16-12h	ZOR12732030	41,26
32	ORFS 1"11/16-12h	ZOR12732032	41,26
38	ORFS 2"-12h	ZOR12732438	67,47

ORFS Male plug

Tapón macho ORFS

Verschlussschraube TYP ORFS

Bouchon mâle ORFS



ROSCA THREAD	Referencia Part n°	€
ORFS 9/16"-18h	ZOR1040400	11,59
ORFS 11/16"-16h	ZOR1040600	14,93
ORFS 13/16"-16h	ZOR1040800	15,51
ORFS 1"-14h	ZOR1041000	26,98
ORFS 1"3/16-12h	ZOR1041200	27,84
ORFS 1"7/16-12h	ZOR1041600	39,52
ORFS 1"11/16-12h	ZOR1042000	50,53
ORFS 2"-12h	ZOR1042400	69,91

ORFS cap

Tapón hembra ORFS

Verschluss ORFS

Bouchon femelle ORFS



ROSCA THREAD	Referencia Part n°	€
ORFS 9/16"-18h	ZOR1050400	16,15
ORFS 11/16"-16h	ZOR1050600	18,09
ORFS 13/16"-16h	ZOR1050800	20,80
ORFS 1"-14h	ZOR1051000	30,81
ORFS 1"3/16-12h	ZOR1051200	41,08
ORFS 1"7/16-12h	ZOR1051600	47,31
ORFS 1"11/16-12h	ZOR1052000	62,77
ORFS 2"-12h	ZOR1052400	91,41

ORFS Male adaptor

Adaptador macho-macho ORFS

Doppelnippel m - m ORFS

Adapteur mâle ORFS



ROSCA THREAD	ROSCA THREAD	Referencia Part n°	€
ORFS 9/16"-18h	ORFS 9/16"-18h	ZOR2000404	21,19
ORFS 11/16"-16h	ORFS 11/16"-16h	ZOR2000606	21,54
ORFS 13/16"-16h	ORFS 13/16"-16h	ZOR2000808	26,29
ORFS 1"-14h	ORFS 1"-14h	ZOR2001010	37,66
ORFS 1"3/16-12h	ORFS 1"3/16-12h	ZOR2001212	30,45
ORFS 1"7/16-12h	ORFS 1"7/16-12h	ZOR2001616	47,05
ORFS 1"11/16-12h	ORFS 1"11/16-12h	ZOR2002020	63,72
ORFS 2"-12h	ORFS 2"-12h	ZOR2002424	86,91

ORFS Male - BSP Male

Adaptador macho ORFS-macho BSP

Doppelnippel m ORFS - m BSP

Adapteur mâle ORFS - mâle BSP



ROSCA THREAD	ROSCA THREAD	Referencia Part n°	€
ORFS 9/16"-18h	BSP 1/4"	ZOR2020404	20,54
ORFS 11/16"-16h	BSP 3/8"	ZOR2020606	20,60
ORFS 13/16"-16h	BSP 3/8"	ZOR2020806	35,35
ORFS 13/16"-16h	BSP 1/2"	ZOR2020808	29,46
ORFS 1"3/16-12h	BSP 1/2"	ZOR2021208	55,04
ORFS 1"3/16-12h	BSP 3/4"	ZOR2021212	41,28
ORFS 1"7/16-12h	BSP 1"	ZOR2021616	55,44
ORFS 1"7/16-12h	BSP 1" 1/4	ZOR2021620	97,81
ORFS 1"11/16-12h	BSP 1"	ZOR2022016	114,93
ORFS 1"11/16-12h	BSP 1" 1/4	ZOR2022020	86,20
ORFS 2"-12h	BSP 1" 1/2	ZOR2022424	121,46

ORFS Adaptors

Adaptadores ORFS

Adapter ORFS

Adpteurs ORFS

ORFS Male - Metric Male

Adaptador macho ORFS-macho Métrico

Doppelnippel m ORFS-m metr.

Adapteur mâle ORFS - mâle Métrique



ROSCA THREAD		Referencia Part n°	€
ORFS 9/16"-18h	M12x1.5	ZOR10170412	22,16
ORFS 11/16"-16h	M16x1.5	ZOR10170616	24,13
ORFS 13/16"-16h	M18x1.5	ZOR10170818	32,73
ORFS 1"-14h	M22x1.5	ZOR10171022	44,09
ORFS 1"7/16-12h	M33x2	ZOR10171633	56,69
ORFS 1"11/16-12h	M42x2	ZOR10172042	102,32
ORFS 2"-12h	M48x2	ZOR10172448	149,96

ORFS Bulkhead

Pasatabiques ORFS

Schottverschraubungen ORFS SV- ORFS

Passe-cloison ORFS



ROSCA THREAD	Referencia Part n°	€
ORFS 9/16"-18h	ZOR1060404	38,38
ORFS 11/16"-16h	ZOR1060606	43,87
ORFS 13/16"-16h	ZOR1060808	48,28
ORFS 1"-14h	ZOR1061010	81,14
ORFS 1"3/16-12h	ZOR1061212	93,48
ORFS 1"7/16-12h	ZOR1061616	112,14
ORFS 1"11/16-12h	ZOR1062020	131,23
ORFS 2"-12h	ZOR1062424	182,47

ORFS Male - ORFS Swivel female

Adaptador macho-hembra giratoria ORFS

Adapter m O'Ring Boss - w mit Ü-Mutter ORFS

Adapteur mâle - femelle tournante ORFS



ROSCA (H) THREAD (F)	ROSCA (M) THREAD (M)	Referencia Part n°	€
ORFS 9/16"-18h	ORFS 11/16"-16h	ZOR3010406	22,90
ORFS 11/16"-16h	ORFS 9/16"-18h	ZOR3010604	22,58
ORFS 13/16"-16h	ORFS 9/16"-18h	ZOR3010804	28,12
ORFS 13/16"-16h	ORFS 11/16"-16h	ZOR3010806	25,78
ORFS 1"-14h	ORFS 9/16"-18h	ZOR3011004	40,60
ORFS 1"-14h	ORFS 11/16"-16h	ZOR3011006	39,30
ORFS 1"-14h	ORFS 13/16"-16h	ZOR3011008	37,87
ORFS 1"3/16-12h	ORFS 11/16"-16h	ZOR3011206	70,05
ORFS 1"3/16-12h	ORFS 13/16-16h	ZOR3011208	61,65
ORFS 1"3/16-12h	ORFS 1"-14h	ZOR3011210	56,98
ORFS 1"7/16-12h	ORFS 13/16"-16h	ZOR3011608	69,59
ORFS 1"7/16-12h	ORFS 1"-14h	ZOR3011610	67,49
ORFS 1"7/16-12h	ORFS 1"3/16-12h	ZOR3011612	73,85
ORFS 1"11/16-12h	ORFS 1"3/16-12h	ZOR3012012	77,05
ORFS 1"11/16-12h	ORFS 1"7/16-12h	ZOR3012016	90,12

ORFS Male - 37° JIC Male

Adaptador macho ORFS-macho JIC 37°

Doppelnippel m ORFS-m JIC 37°

Adapteur mâle ORFS - mâle JIC 37°



ROSCA THREAD		Referencia Part n°	€
ORFS 9/16"-18h	JIC 7/16"	ZOR2040404	15,73
ORFS 11/16"-16h	JIC 9/16"	ZOR2040606	19,63
ORFS 13/16"-16h	JIC 3/4"	ZOR2040808	20,41
ORFS 1"-14h	JIC 7/8"	ZOR2041010	23,31
ORFS 1"3/16-12h	JIC 1"1/16	ZOR2041212	30,61
ORFS 1"7/16-12h	JIC 1"5/16	ZOR2041616	48,29
ORFS 1"11/16"-12h	JIC 1"5/8	ZOR2042020	72,84
ORFS 2"-12h	JIC 1"7/8	ZOR2042424	104,28

ORFS Male - 37° JIC Swivel female

Adaptador macho ORFS-hembra giratoria JIC 37°

Adapter m ORFS - w mit Ü-Mutter JIC 37°

Adapteur mâle ORFS - femelle tournante JIC 37°



ROSCA THREAD		Referencia Part n°	€
ORFS 9/16"-18h	JIC 7/16"	ZOR3020404	19,70
ORFS 11/16"-16h	JIC 9/16"	ZOR3020606	25,29
ORFS 13/16"-16h	JIC 3/4"	ZOR3020808	26,49
ORFS 1"-14h	JIC 7/8"	ZOR3021010	33,95
ORFS 1"3/16-12h	JIC 1"1/16	ZOR3021212	38,92
ORFS 1"7/16-12h	JIC 1"5/16	ZOR3021616	56,66
ORFS 1"11/16-12h	JIC 1"5/8	ZOR3022020	71,26
ORFS 2"-12h	JIC 1"7/8	ZOR3022424	83,65

JIC Male - ORFS Swivel female

Adaptador macho JIC 37°-hembra giratoria ORFS

JIC m - w mit Ü-Mutter ORFS

Adapteur mâle JIC 37° - femelle tournante ORFS



ROSCA THREAD		Referencia Part n°	€
JIC 7/16"	ORFS 9/16"-18 h	ZOR3050404	21,20
JIC 9/16"	ORFS 11/16"-16h	ZOR3050606	24,74
JIC 3/4"	ORFS 13/16"-16 h	ZOR3050808	30,62
JIC 7/8"	ORFS 1"-14h	ZOR3051010	37,23
JIC 1"1/16	ORFS 1"3/16-12 h	ZOR3051212	46,61
JIC 1"5/16	ORFS 1"7/16-12 h	ZOR3051616	72,57
JIC 1"5/8	ORFS 1"11/16"-12h	ZOR3052020	85,68
JIC 1"7/8"	ORFS 2"-12h	ZOR3052424	99,30

ORFS Adaptors

Adaptadores ORFS

Adapter ORFS

Adapteurs ORFS

90° ORFS male - ORFS male

Codo 90° macho-macho ORFS

90° Winkel m - m ORFS

Coude 90° mâle ORFS - mâle ORFS



ROSCA THREAD	Referencia Part n°	€
ORFS 9/16"-18h	ZOR4050404	30,55
ORFS 11/16"-16h	ZOR4050606	34,84
ORFS 13/16"-16h	ZOR4050808	43,33
ORFS 1"-14h	ZOR4051010	61,67
ORFS 1"3/16-12h	ZOR4051212	74,30
ORFS 1"7/16-12h	ZOR4051616	90,78
ORFS 1"11/16-12h	ZOR4052020	157,39
ORFS 2"-12h	ZOR4052424	194,96

90° ORFS swivel female - ORFS male

Codo 90° macho-hembra giratoria ORFS

90° Winkel m - w mit Ü-Mutter ORFS

Coude 90° femelle tournante ORFS- mâle ORFS



ROSCA (M) THREAD (M)	ROSCA (H) THREAD (F)	Referencia Part n°	€
ORFS 9/16"-18h	ORFS 9/16"-18h	ZOR6000404	35,39
ORFS 11/16"-16h	ORFS 11/16"-16h	ZOR6000606	53,69
ORFS 13/16"-16h	ORFS 13/16"-16h	ZOR6000808	78,17
ORFS 1"-14h	ORFS 1"-14h	ZOR6001010	89,94
ORFS 1"3/16-12h	ORFS 1"3/16-12h	ZOR6001212	102,49
ORFS 1"7/16-12h	ORFS 1"7/16-12h	ZOR6001616	126,82
ORFS 1"11/16-12h	ORFS 1"11/16-12h	ZOR6002020	154,69

ORFS Male Tee

Te macho-macho-macho ORFS

T-Verschraubung m-m-m - ORFS

Té Mâle ORFS



ROSCA THREAD	Referencia Part n°	€
ORFS 9/16"18h	ZOR7000404	41,09
ORFS 11/16"-16h	ZOR7000606	52,81
ORFS 13/16"-16h	ZOR7000808	67,79
ORFS 1"-14h	ZOR7001010	86,43
ORFS 1"3/16-12h	ZOR7001212	91,47
ORFS 1"7/16-12h	ZOR7001616	137,18
ORFS 1"11/16-12h	ZOR7002020	175,34
ORFS 2"-12h	ZOR7002424	227,05

ORFS Male-Swivel female-Male Tee

Te macho-hembra giratoria-macho ORFS

T-Verschraubungen ORFS m - w Ü-Mutter - m

Té Mâle-Femelle tournante-Mâle ORFS



ROSCA THREAD	Referencia Part n°	€
ORFS 9/16"-18h	ZOR7010404	66,78
ORFS 11/16"-16h	ZOR7010606	68,27
ORFS 13/16"-16h	ZOR7010808	74,95
ORFS 1"-14h	ZOR7011010	107,75
ORFS 1"3/16-12h	ZOR7011212	144,10
ORFS 1"7/16-12h	ZOR7011616	175,17
ORFS 1"11/16-12h	ZOR7012020	216,23
ORFS 2"-12h	ZOR7012424	284,43

ORFS Male-Male-Swivel Female Tee

Te macho-macho-hembra giratoria ORFS

T-Verschraubungen m - m - w mit Ü-Mutter ORFS

Té Mâle-Mâle-Femelle tournante ORFS



ROSCA THREAD	Referencia Part n°	€
ORFS 9/16"-18h	ZOR7020404	66,78
ORFS 11/16"-16h	ZOR7020606	70,22
ORFS 13/16"-16h	ZOR7020808	77,95
ORFS 1"-14h	ZOR7021010	107,75
ORFS 1"3/16-12h	ZOR7021212	142,44
ORFS 1"7/16-12h	ZOR7021616	175,17
ORFS 1" 11/16-12h	ZOR7022020	198,58

O'ring FKM green for ORFS thread

Juntas tóricas FKM verde para rosca ORFS

O-Ringe FKM grün für ORFS

Joint torique FKM vert pour filetage ORFS



ROSCA THREAD	Referencia Part n°	€
ORFS 9/16"-18h	JVORFS04	0,49
ORFS 11/16"-16h	JVORFS06	0,54
ORFS 13/16"-16h	JVORFS08	0,60
ORFS 1"-14h	JVORFS10	0,68
ORFS 1"3/16-12h	JVORFS12	0,92
ORFS 1"7/16-12h	JVORFS16	1,44
ORFS 1" 11/16-12h	JVORFS20	1,81
ORFS 2"-12h	JVORFS24	2,15

Welding fittings 195

Racores soldables
Schweißverschraubungen
Embouts à souder

Welding flanges 203

Bridas soldables
Schweißflansche
Brides à souder

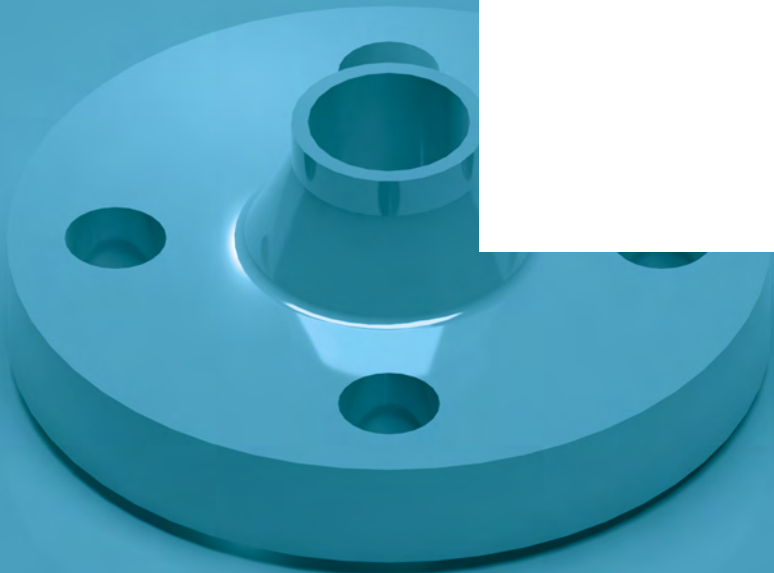
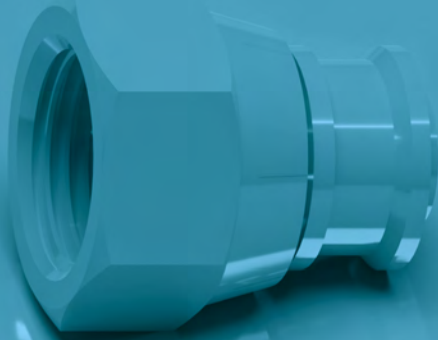

05

WELDING FITTINGS

Racores soldables

Schweißverschraubungen

Embouts à souder

Welding fittings

Racores soldables
Schweißerschraubungen
Embouts à souder

Welding Male ▪ Racores macho para soldar ▪ Schweißversch. m ▪ Raccords mâle à souder

| 195



81070

Z1035

Z10351

Z1033

Z1290

Z1032

Z1034

Welding BSP nuts ▪ Racores BSP para soldar ▪ Schweißarmaturen BSP ▪ Écrous tournants à souder

| 196



Z1281

Z1037

Z1038

Z1282

Z1039

Z1040

Welding JIC fittings ▪ Racores JIC para soldar ▪ Schweißversch. JIC ▪ Raccords JIC à souder

| 197



Z1283

Z1036

Z1041

Z1042

Z1284

Welding metric fittings ▪ Racores Métricos para soldar ▪ Metr. Schweißversch. ▪ Raccords métriques à souder

| 198



Z1051

ZCMORIL/S

KZL00

KZC90

KZC45

Z1052

Z1054

Z1053

Z1055

Z1050

Welding fittings >2" ▪ BSP >2" ▪ Schweißnippel >2" ▪ Raccords à souder >2"

| 200



Z1270

Z12784

ZM1032

Other welding BSP fittings ▪ Conos ajuste BSP ▪ Andere Schweißversch. BSP ▪ Autres raccords à souder BSP

| 201



Z1270

Z1273

Z1274

Other welding JIC fittings ▪ Conos ajuste JIC ▪ Andere Schweißversch. JIC ▪ Autres raccords à souder JIC

| 201



Z1277

Z5110

Welding fittings microcast ▪ Racores Microfundido para soldar ▪ Schweißversch. Mikroguss ▪ Raccords à souder micro-moulés

| 202



ZFIG340...HS

ZFIG340...S

ZFIG341...MS

Welding flanges

Bridas soldables
Schweißflansche
Brides à souder

Fixed Forged flanges ▪ Bridas fijas para soldar ▪ Vorschweißflansche ▪ Brides DIN à souder fixes

203



ZBPN162633



ZBPN402635



ZBANSAWN150



ZBANSAWN300

DIN 2642 swivel flanges set ▪ Conjunto bridas DIN 2642 ▪ Flanschsatz DIN 2642 ▪ Ensemble brides tournantes DIN 2642

204



ZBPN102642

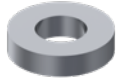

ZABARO2642



ZBTUBO

DIN 2656 swivel flanges set ▪ Conjunto bridas DIN 2656 ▪ Flanschsatz DIN 2656 ▪ Ensemble brides tournantes DIN 2656

205



ZBPN402656

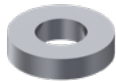

ZABARO2656



ZBTUBO

ANSI-ASA swivel flanges set ▪ Conjunto bridas ANSI-ASA ▪ Flanschsatz ANSI-ASA ▪ Ensemble brides ANSI-ASA

206



ZBANSAO150



ZBANSAO300

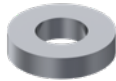

ZABAROANSA



ZBTUBO

DICSA

CONSULTA EL
CATÁLOGO DE
CONDUCCIONES



CHECK OUR
CONNECTORS
CATALOGUE

www.dicsaes.com

MANGUERAS ACERO INOXIDABLE STAINLESS STEEL HOSES

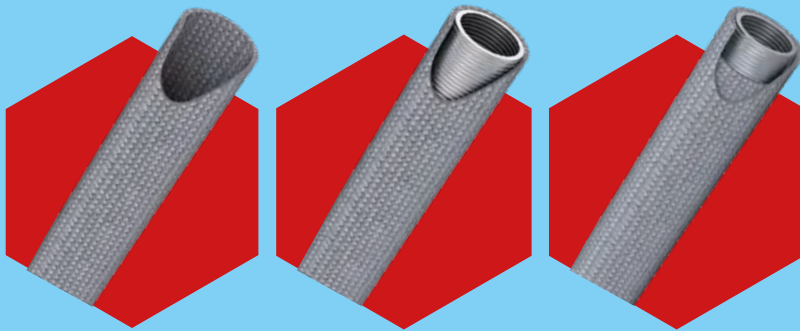

Mangueras de inoxidable corrugado para instalaciones en el sector químico, centrales eléctricas y plantas petroquímicas.

Convoluted stainless steel hoses for a variety of facilities, such as chemical sector, power plant, oil and gas.

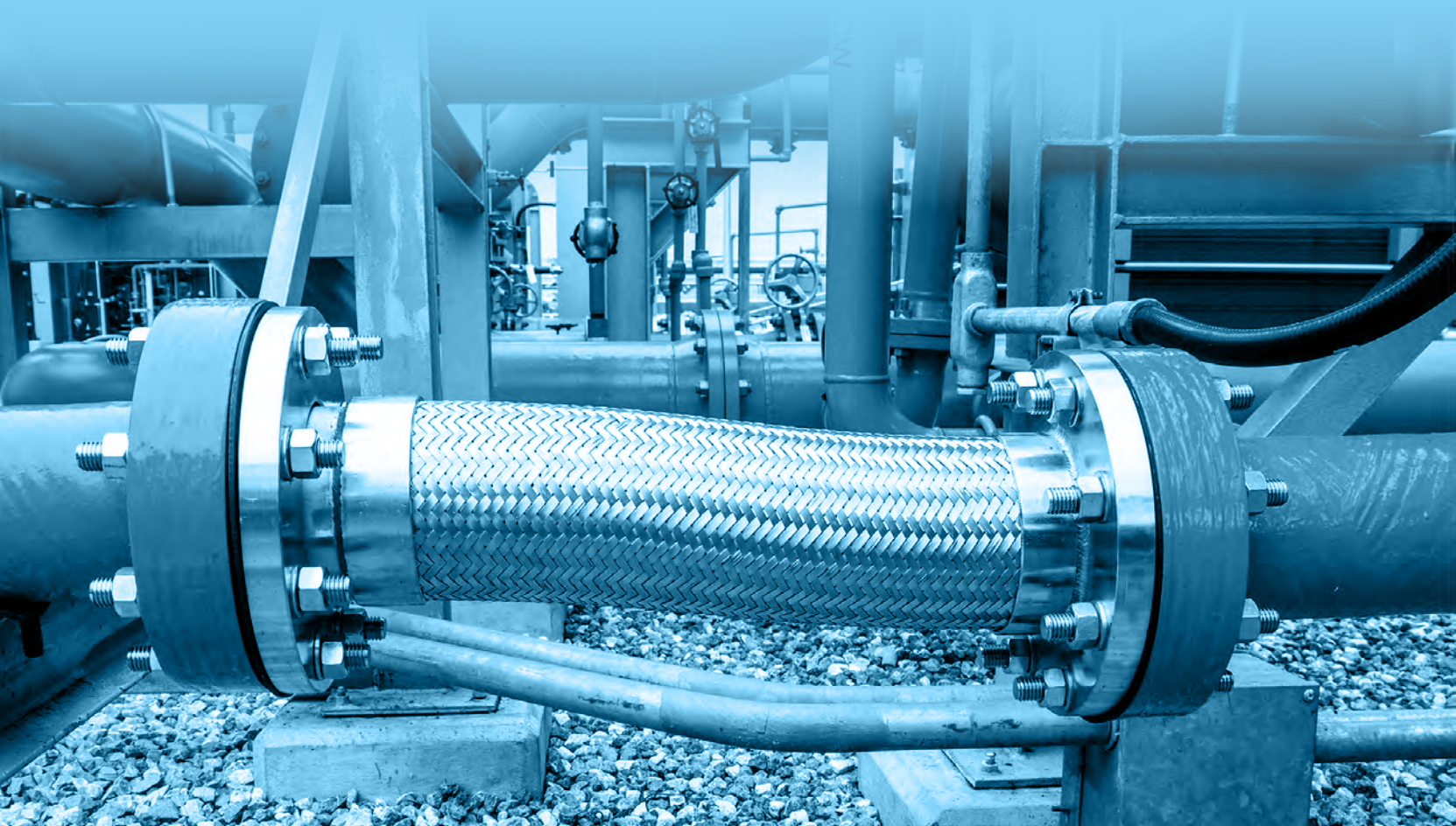
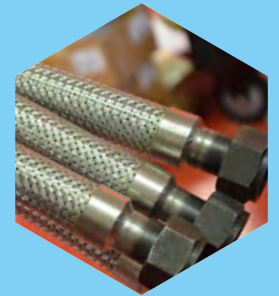

Welding fittings

Racores soldables
Schweißverschraubungen
Embout à souder

Welding ferrule

Casquillo soldable

Pressfassungen für Ringwellschläuche

Juqe à souder



DN	Ø INT. Ø INNER	Referencia Part n°	€
1/4"	14	810700400	1,67
1/4"	12	810700401	1,80
3/8"	19	810700600	2,60
3/8"	17	810700601	1,91
1/2"	22	810700800	2,44
1/2"	19	810700801	2,44
5/8"	25	810701000	2,83
3/4"	30	810701200	3,01
3/4"	32	810701201	3,30
1"	35	810701500	3,45
1"	37	810701600	5,56
1"1/4	47,8	810702000	6,34
1"1/4	44,3	810702001	6,13
1"1/2	56,3	810702400	7,41
2"	66	810703201	11,54
2"1/2	84,9	810704000	15,48
2"1/2	95,6	810704001	23,17
3"	100	810704801	27,05
4"	125	810706400	35,86

Welding BSP 60° Male with guide

Macho soldable BSP cono 60° con guía

Schweiß-Außengewinde BSP mit AG

Mâle gaz BSP 60° à souder avec guide



ROSCA THREAD	DN	Referencia Part n°	€
1/4" BSP	1/4"	Z103504	12,58
3/8" BSP	3/8"	Z103506	12,67
1/2" BSP	1/2"	Z103508	13,54
3/4" BSP	3/4"	Z103512	18,89
1" BSP	1"	Z103516	30,27
1"1/4 BSP	1"1/4	Z103520	48,87
1"1/2 BSP	1"1/2	Z103524	67,74
2" BSP	2"	Z103532	85,36

Inside welding BSP Male

Macho BSP 60° soldable interior

Außengewinde BSP 60° innen schweißbar

Mâle à souder int. BSP



ROSCA THREAD	DN	Referencia Part n°	€
1/4" BSP	1/4"	Z1035104	13,31
3/8" BSP	3/8"	Z1035106	17,03
1/2" BSP	1/2"	Z1035108	18,31
3/4" BSP	3/4"	Z1035112	23,71
1" BSP	1"	Z1035116	32,00
1"1/4 BSP	1"1/4	Z1035120	49,10
1"1/2 BSP	1"1/2	Z1035124	59,41
2" BSP	2"	Z1035132	99,65

Welding BSP Male flat seat with guide

Macho soldable BSP asiento plano con guía

Schweiß-Außengewinde flachdichtend BSP

Mâle gaz BSP fond plat à souder avec guide



ROSCA THREAD	DN	Referencia Part n°	€
1/4" BSP	1/4"	Z103304	12,13
3/8" BSP	3/8"	Z103306	19,41
1/2" BSP	1/2"	Z103308	14,85
3/4" BSP	3/4"	Z103312	19,69
1" BSP	1"	Z103316	31,51
1"1/4 BSP	1"1/4	Z103320	59,63
1"1/2 BSP	1"1/2	Z103324	79,86
2" BSP	2"	Z103332	108,32

Welding male BSP 60° union

Empalme liso soldable macho BSP 60°

Anschweißnippel BSP 60°

Embout mâle lisse à souder BSP cône 60°



ROSCA THREAD	DN	Referencia Part n°	€
1/8" BSP	1/8"	Z129002	8,06
1/4" BSP	1/4"	Z129004	8,26
3/8" BSP	3/8"	Z129006	10,31
1/2" BSP	1/2"	Z129008	10,49
3/4" BSP	3/4"	Z129012	17,67
1" BSP	1"	Z129016	25,06
1"1/4 BSP	1"1/4	Z129020	34,45
1"1/2 BSP	1"1/2	Z129024	45,39
2" BSP	2"	Z129032	98,75

Welding BSPT Male 60° with guide

Macho soldable BSPT cono 60° con guía

Schweiß-Außengewinde BSPT mit AG

Mâle gaz conique à souder 60° avec guide



ROSCA THREAD	DN	Referencia Part n°	€
1/4" BSPT	1/4"	Z103204	11,45
3/8" BSPT	3/8"	Z103206	14,19
1/2" BSPT	1/2"	Z103208	13,77
3/4" BSPT	3/4"	Z103212	19,31
1" BSPT	1"	Z103216	27,20
1"1/4 BSPT	1"1/4	Z103220	48,74
1"1/2 BSPT	1"1/2	Z103224	55,65
2" BSPT	2"	Z103232	94,84

Welding fittings

Racores soldables
Schweißverschraubungen
Embouts à souder

Welding NPT Male 60° with guide

Macho soldable NPT cono 60° con guía

Schweiß-Außengewinde NPT mit AG

Mâle NPT à souder 60° avec guide



ROSCA THREAD	DN	Referencia Part n°	€
1/8" NPT	1/4"	Z10340204	21,44
1/4" NPT	1/4"	Z10340400	11,22
3/8" NPT	3/8"	Z10340600	13,04
1/2" NPT	1/2"	Z10340800	14,95
3/4" NPT	3/4"	Z10341200	20,24
1" NPT	1"	Z10341600	28,02
1"1/4 NPT	1"1/4"	Z10342000	48,65
1"1/2 NPT	1"1/2"	Z10342400	51,67
2" NPT	2"	Z10343200	98,70

Welding BSP 60° swept with guide

Hembra giratoria prensada soldable BSP 60° con guía

Schweiß-Dichtkopf mit Ü-Mutter BSP mit AG

Femelle tournante BSP 60° à souder avec guide



ROSCA THREAD	DN	Referencia Part n°	€
1/4" BSP	1/4"	Z128104	11,27
3/8" BSP	3/8"	Z128106	12,34
1/2" BSP	1/2"	Z128108	15,40
3/4" BSP	3/4"	Z128112	20,69
1" BSP	1"	Z128116	31,66
1"1/4 BSP	1"1/4"	Z128120	55,01
1"1/2 BSP	1"1/2"	Z128124	64,16
2" BSP	2"	Z128132	104,29

Welding BSP 60° swept 90°

Hembra giratoria 90° prensada soldable BSP 60°

Schweiß-Dichtkopf 90° mit Ü-Mutter BSP 60°

Femelle tournante à souder 90° BSP cône 60°



ROSCA THREAD	DN	Referencia Part n°	€
1/4" BSP	1/4"	Z103704	24,71
3/8" BSP	3/8"	Z103706	29,10
1/2" BSP	1/2"	Z103708	34,35
3/4" BSP	3/4"	Z103712	50,80
1" BSP	1"	Z103716	62,74
1"1/4 BSP	1"1/4"	Z103720	101,59
1"1/2 BSP	1"1/2"	Z103724	134,18
2" BSP	2"	Z103732	142,00

Welding BSP 60° swept 45°

Hembra giratoria 45° prensada soldable BSP 60°

Schweiß-Dichtkopf 45° mit Ü-Mutter BSP 60°

Femelle tournante à souder 45° BSP cône 60°



ROSCA THREAD	DN	Referencia Part n°	€
1/4" BSP	1/4"	Z103804	25,02
3/8" BSP	3/8"	Z103806	29,90
1/2" BSP	1/2"	Z103808	37,58
3/4" BSP	3/4"	Z103812	50,70
1" BSP	1"	Z103816	63,61
1"1/4 BSP	1"1/4"	Z103820	107,22
1"1/2 BSP	1"1/2"	Z103824	134,12
2" BSP	2"	Z103832	150,45

Welding BSP flat seat swept with guide

Hembra giratoria prensada soldable BSP asiento plano con guía

Schweiß-Dichtkopf BSP flachdichtend

Femelle tournante BSP fond plat à souder avec guide



ROSCA THREAD	DN	Referencia Part n°	€
1/4" BSP	1/4"	Z128204	11,89
3/8" BSP	3/8"	Z128206	13,79
1/2" BSP	1/2"	Z128208	15,11
3/4" BSP	3/4"	Z128212	18,82
1" BSP	1"	Z128216	27,59
1"1/4 BSP	1"1/4"	Z128220	52,68
1"1/2 BSP	1"1/2"	Z128224	72,50
2" BSP	2"	Z128232	105,07

Welding BSP Female 90° flat seat swept

Hembra giratoria 90° prensada soldable BSP asiento plano

Schweiß-Dichtkopf 90° BSP flachdichtend

Femelle tournante à souder 90° BSP fond plat



ROSCA THREAD	DN	Referencia Part n°	€
1/4" BSP	1/4"	Z103904	31,35
3/8" BSP	3/8"	Z103906	36,81
1/2" BSP	1/2"	Z103908	37,04
3/4" BSP	3/4"	Z103912	56,28
1" BSP	1"	Z103916	66,91
1"1/4 BSP	1"1/4"	Z103920	119,43
1"1/2 BSP	1"1/2"	Z103924	139,24
2" BSP	2"	Z103932	150,19

Welding fittings

Racores soldables
Schweißverschraubungen
Embouts à souder

Welding BSP Female 45° flat seat swept

Hembra giratoria 45° prensada soldable BSP
asiento plano

Schweiß-Dichtkopf 45° mit Ü-Mutter BSP
flachdichtend

Femelle tournante à souder 45° BSP fond plat



ROSCA THREAD	DN	Referencia Part n°	€
1/4" BSP	1/4"	Z104004	31,66
3/8" BSP	3/8"	Z104006	37,18
1/2" BSP	1/2"	Z104008	37,41
3/4" BSP	3/4"	Z104012	56,84
1" BSP	1"	Z104016	67,58
1 1/4" BSP	1 1/4"	Z104020	120,62
1 1/2" BSP	1 1/2"	Z104024	140,64
2" BSP	2"	Z104032	151,69

Welding JIC female 37° swept with guide

Hembra giratoria prensada soldable JIC 37° con
guía

Schweiß-Dichtkopf mit Ü-Mutter JIC 37° mit AG

Femelle tournante JIC 37° à souder avec guide



ROSCA THREAD	DN	Referencia Part n°	€
7/16" 20h UNF	1/4"	Z12830704	17,38
1/2" 20h UNF	1/4"	Z12830804	15,63
9/16" 18h UNF	3/8"	Z12830906	14,37
3/4" 16h UNF	3/8"	Z12831206	17,92
3/4" 16h UNF	1/2"	Z12831208	15,44
7/8" 14h UNF	1/2"	Z12831408	16,94
7/8" 14h UNF	5/8"	NEW Z12831410	20,51
1 1/16 12h UN	3/4"	Z12831712	21,24
1 5/16 12h UN	1"	Z12832116	28,17
1 5/8 12h UN	1 1/4"	Z12832620	53,27
1 7/8 12h UN	1 1/2"	Z12833024	78,94

Welding fixed male JIC 37° with guide

Macho soldable JIC 37° con guía

Schweiß-Außengewinde JIC 37° mit AG

Mâle à souder JIC 37° avec guide



ROSCA THREAD	DN	Referencia Part n°	€
7/16" 20h UNF	1/4"	Z10360704	12,65
1/2" 20h UNF	1/4"	Z10360804	12,49
9/16" 18h UNF	3/8"	Z10360906	14,33
3/4" 16h UNF	3/8"	Z10361206	16,15
3/4" 16h UNF	1/2"	Z10361208	15,79
7/8" 14h UNF	1/2"	Z10361408	17,50
7/8" 14h UNF	5/8"	Z10361410	18,13
1 1/16 12h UN	3/4"	Z10361712	22,68
1 5/16 12h UN	1"	Z10362116	35,44
1 5/8 12h UN	1 1/4"	Z10362620	47,00
1 7/8 12h UN	1 1/4"	Z10363020	75,68
1 7/8 12h UN	1 1/2"	NEW Z10363024	79,88
2" 1/2 12h UN	2"	Z10364032	116,05

Welding 90° JIC Female 37° swept

Hembra giratoria 90° prensada soldable JIC 37°

Schweiß-Dichtkopf 90° mit Ü-Mutter JIC 37°

Femelle tournante à souder 90° JIC 37°



ROSCA THREAD	DN	Referencia Part n°	€
7/16" 20h UNF	1/4"	Z10410704	24,98
1/2" 20h UNF	1/4"	Z10410804	21,78
9/16" 18h UNF	3/8"	Z10410906	28,00
3/4" 16h UNF	1/2"	Z10411208	30,62
7/8" 14h UNF	1/2"	Z10411408	34,56
1 1/16 12h UN	3/4"	Z10411712	48,71
1 5/16 12h UN	1"	Z10412116	58,31
1 5/8 12h UN	1 1/4"	Z10412620	93,18
1 7/8 12h UN	1 1/2"	Z10413024	157,97

Welding 45° JIC Female 37° swept

Hembra giratoria 45° prensada soldable JIC 37°

Schweiß-Dichtkopf 45° mit Ü-Mutter JIC 37°

Femelle tournante à souder 45° JIC 37°



ROSCA THREAD	DN	Referencia Part n°	€
7/16" 20h UNF	1/4"	Z10420704	25,23
1/2" 20h UNF	1/4"	Z10420804	21,99
9/16" 18h UNF	3/8"	Z10420906	28,28
3/4" 16h UNF	1/2"	Z10421208	30,92
7/8" 14h UNF	1/2"	Z10421408	34,91
1 1/16 12h UN	3/4"	Z10421712	49,20
1 5/16 12h UN	1"	Z10422116	58,89
1 5/8 12h UN	1 1/4"	Z10422620	94,11
1 7/8 12h UN	1 1/2"	Z10423024	159,55

Welding JIC female 37° swept with guide double hexagon

Hembra giratoria prensada soldable JIC 37° con
guía doble hexágono

Schweiß-Dichtkopf mit Ü-Mutter JIC 37° mit AG
D/S

Femelle tournante JIC 37° à souder avec guide
double hex.



ROSCA THREAD	DN	Referencia Part n°	€
7/16" 20 UNF	1/4"	Z12840704	15,16
1/2" 20 UNF	1/4"	Z12840804	17,24
9/16" 18 UNF	3/8"	Z12840906	15,95
3/4" 16 UNF	1/2"	Z12841208	17,77
7/8" 14 UNF	1/2"	Z12841408	20,89
7/8" 14 UNF	5/8"	NEW Z12841410	23,29
1" 1/16 12 UN	3/4"	Z12841712	25,12
1 5/16 12 UN	1"	Z12842116	34,74
1 5/8 12 UN	1 1/4"	Z12842620	74,08
1 7/8 12 UN	1 1/2"	Z12843024	91,48
2" 1/2 12 UN	2"	NEW Z12844032	178,52

Welding fittings

Racores soldables
Schweißverschraubungen
Embouts à souder

DIN nut

Tuercas Métricas

Metr. Muttern - M DIN

Écrou DIN



TUBO PIPE	ROSCA THREAD	Referencia Part n°	€
6	M12X1.5	Z10510612	2,30
6	M14X1.5	Z10510614	3,01
8	M14X1.5	Z10510814	2,77
8	M16X1.5	Z10510816	3,40
10	M16X1.5	Z10511016	3,19
10	M18X1.5	Z10511018	4,25
12	M18X1.5	Z10511218	3,83
12	M20X1.5	Z10511220	4,72
14	M22X1.5	Z10511422	7,68
15	M22X1.5	Z10511522	5,55
16	M24X1.5	Z10511624	8,53
18	M26X1.5	Z10511826	8,62
20	M30X2	Z10512030	12,99
22	M30X2	Z10512230	11,19
25	M36X2	Z10512536	30,69
28	M36X2	Z10512836	23,03
30	M42X2	Z10513042	39,46
35	M45X2	Z10513545	38,51
38	M52X2	Z10513852	60,00
42	M52X2	Z10514252	48,07

Welding metal cone nipple

Boquilla para soldar cono metal

Schweißkegel Metallkonus

Raccord collet cône métallique à souder



TUBO PIPE	SERIE	Referencia Part n°	€
15X2,5	L	Z CMORIL 15	13,45
18X2,5	L	Z CMORIL 18	14,26
22X2,5	L	Z CMORIL 22	17,96
28X3	L	Z CMORIL 28	21,14
35X4	L	Z CMORIL 35	40,41
42X3	L	Z CMORIL 42	55,55
6X2	L/S	Z CMORIS 6	7,27
8X2	L/S	Z CMORIS 8	9,89
10X2	L/S	Z CMORIS 10	9,93
12X2	L/S	Z CMORIS 12	10,33
14X3	S	Z CMORIS 14	11,38
16X3	S	Z CMORIS 16	13,73
20X3	S	Z CMORIS 20	15,73
25X4	S	Z CMORIS 25	24,56
30X5	S	Z CMORIS 30	29,90
38X5	S	Z CMORIS 38	39,40

If you want the item with o'ring, please see page 118 / En caso de querer la pieza con junta, ver pág. 118 / Im Fall des Bedarfs des Artikels mit Dichtung vgl. Sie bitte S. 118 / Si vous voulez la pièce avec le joint, voir page 118

Welding metric standpipe

Espiga lisa métrica recta

Metr. Schweißstutzen glatt

Embout lisse métrique à souder



Ø EXT. Ø OUTER	Ø INT. Ø INNER	Referencia Part n°	€
10	7	KZL0010	7,14
12	9	KZL0012	7,38
14	10	KZL0014	10,18
15	12	KZL0015	9,76
16	12	KZL0016	11,04
18	14	KZL0018	14,43
20	14	KZL0020	17,34
22	18	KZL0022	18,51
28	24	KZL0028	63,26

Welding metric standpipe 90°

Espiga lisa métrica 90°

Metr. Schweißstutzen 90° glatt

Embout lisse métrique 90° à souder



Ø EXT. Ø OUTER	Ø INT. Ø INNER	Referencia Part n°	€
6	4	KZC9006	7,73
8	4	KZC9008	11,28
10	6	KZC9010	11,37
12	8	KZC9012	11,87
15	11	KZC9015	15,13
18	14	KZC9018	20,29
20	12	KZC9020	23,90
22	18	KZC9022	27,85

Welding metric standpipe 45°

Espiga lisa métrica 45°

Metr. Schweißstutzen 45° glatt

Embout lisse métrique 45° à souder



Ø EXT. Ø OUTER	Ø INT. Ø INNER	Referencia Part n°	€
6	4	KZC4506	7,73
8	4	KZC4508	11,28
10	6	KZC4510	11,37
12	8	KZC4512	11,87
14	10	KZC4514	13,94
15	11	KZC4515	15,13
16	11	KZC4516	17,54
18	14	KZC4518	20,29
20	12	KZC4520	23,91
22	18	KZC4522	27,85

Welding fittings

Racores soldables
Schweißverschraubungen
Embouts à souder

Weldable metrical swivel female 90°

Hembra giratoria 90° soldable métrica

Dichtkopf mit Ü-Mutter 90° metr. schweißbar

Femelle tournante 90° métrique à souder



TUBO PIPE	ROSCA THREAD	Referencia Part n°	€
10	M16X1.5	Z10521610	30,50
12	M18X1.5	Z10521812	27,34
12	M20X1.5	Z10522012	33,86
15	M22X1.5	Z10522215	31,75
18	M26X1.5	Z10522618	43,79
20	M30X2	Z10523020	49,68
22	M30X2	Z10523022	54,09
28	M36X2	Z10523628	76,64
42	M52X2	Z10525242	177,53

Until end of stock / Hasta fin de existencias / Bis zum Ende des Lagerbestandes / Jusqu'à la fin du stock

Weldable metrical swivel female 90° without o-ring

Hembra giratoria 90° soldable métrica sin junta

Dichtkopf mit Ü-Mutter 90° metr. schweißbar ohne Dichtung

Femelle tournante 90° métrique à souder sans joint



TUBO PIPE	ROSCA THREAD	Referencia Part n°	€
6	M12X1.5	Z10541206	21,81
8	M14X1.5	Z10541408	22,41
10	M16X1.5	Z10541610	30,50
12	M18X1.5	Z10541812	27,34
15	M22X1.5	Z10542215	31,75
18	M26X1.5	Z10542618	43,79
22	M30X2	Z10543022	54,09
28	M36X2	Z10543628	76,64
35	M45X2	Z10544535	120,89
42	M52X2	Z10545242	177,53
6	M14X1.5	Z10541406	22,82
8	M16X1.5	Z10541608	24,46
10	M18X1.5	Z10541810	23,66
12	M20X1.5	Z10542012	33,86
14	M22X1.5	Z10542214	25,74
16	M24X1.5	Z10542416	36,70
20	M30X2	Z10543020	49,68
25	M36X2	Z10543625	67,75
30	M42X2	Z10544230	110,72
38	M52X2	Z10545238	151,68

Weldable metrical swivel female 45°

Hembra giratoria 45° soldable métrica

Dichtkopf mit Ü-Mutter Bogen 45° metr. schweißbar

Femelle tournante 45° métrique à souder



TUBO PIPE	ROSCA THREAD	Referencia Part n°	€
10	M16X1.5	Z10531610	31,42
12	M18X1.5	Z10531812	28,16
15	M22X1.5	Z10532215	32,70
22	M30X2	Z10533022	55,72
28	M36X2	Z10533628	78,94
42	M52X2	Z10535242	182,86
20	M30X2	Z10533020	51,17

Until end of stock / Hasta fin de existencias / Bis zum Ende des Lagerbestandes / Jusqu'à la fin du stock

Weldable metrical swivel female 45° without o-ring

Hembra giratoria 45° soldable métrica sin junta

Dichtkopf mit Ü-Mutter Bogen 45° metr. schweißbar ohne Dichtung

Femelle tournante 45° métrique à souder sans joint



TUBO PIPE	ROSCA THREAD	Referencia Part n°	€
6	M12X1.5	Z10551206	22,46
8	M14X1.5	Z10551408	23,08
10	M16X1.5	Z10551610	31,42
12	M18X1.5	Z10551812	28,16
15	M22X1.5	Z10552215	32,70
18	M26X1.5	Z10552618	45,10
22	M30X2	Z10553022	55,72
28	M36X2	Z10553628	78,94
35	M45X2	Z10554535	124,51
42	M52X2	Z10555242	182,86
6	M14X1.5	Z10551406	23,50
8	M16X1.5	Z10551608	25,19
10	M18X1.5	Z10551810	24,37
12	M20X1.5	Z10552012	34,88
14	M22X1.5	Z10552214	26,52
16	M24X1.5	Z10552416	37,80
20	M30X2	Z10553020	51,17
25	M36X2	Z10553625	69,79
30	M42X2	Z10554230	114,04
38	M52X2	Z10555238	156,23

Welding DIN Male

Macho soldable Métrico

Schweiß-Außengewinde metr.

Male métrique à souder



TUBO PIPE	SERIE	Referencia Part n°	€
6	L	Z1050L06	7,98
8	L	Z1050L08	9,48
10	L	Z1050L10	12,24
12	L	Z1050L12	10,09
15	L	Z1050L15	15,91
18	L	Z1050L18	20,52
22	L	Z1050L22	29,84
28	L	Z1050L28	36,00
35	L	Z1050L35	58,47
42	L	Z1050L42	79,90
6	S	Z1050S06	10,94
8	S	Z1050S08	13,16
10	S	Z1050S10	15,18
12	S	Z1050S12	19,80
14	S	Z1050S14	23,31
16	S	Z1050S16	24,35
20	S	Z1050S20	25,11
25	S	Z1050S25	37,00
30	S	Z1050S30	58,85
38	S	Z1050S38	140,40

Welding fittings

Racores soldables
Schweißverschraubungen
Emboutis à souder

Micro-casting BSP nuts AISI-316

Tuercas BSP Microfundido AISI-316

Muttern BSP Mikroguss AISI-316

Écrous BSP en acier moulé AISI-316



ROSCA THREAD	Referencia Part n°	€
2" 1/2 BSP	Z127040	109,76
3" BSP	Z127048	143,21
4" BSP	Z127064	182,60

Micro-casting BSPT welding male AISI-316

Macho BSPT soldar microfundido AISI-316

Außengewinde BSPT schweißbar Mikroguss AISI-316

Mâle BSPT à souder en acier moulé AISI-316



DN	ROSCA THREAD	Referencia Part n°	€
2"1/2	2"1/2 BSPT	ZM103240	117,55
3"	3" BSPT	ZM103248	144,13
4"	4" BSPT	ZM103264	185,52

Welding nipple with 60° cone for BSP nut with guide

Cono ajuste BSP 60° con guía

Schweißnippel DK 60 Dichtkegel 60° mit AG

Collet à souder BSP cône 60° avec guide



DN	ROSCA THREAD	Referencia Part n°	€
2"1/2	2"1/2 BSP	Z127840	89,33
3"	3" BSP	Z127848	113,01
4"	4" BSP	Z127864	206,43

Welding fittings

Racores soldables
Schweißverschraubungen
Embouts à souder

BSP Nut for welding 60° cone nipple

Tuerca cono ajuste BSP

Ü-Mutter BSP für DK

Écrou gaz pour collet à souder



ROSCA THREAD	Referencia Part n°	€
1/4" BSP	Z127004	3,27
3/8" BSP	Z127006	4,36
1/2" BSP	Z127008	6,21
3/4" BSP	Z127012	8,58
1" BSP	Z127016	13,94
1"1/4 BSP	Z127020	24,99
1"1/2 BSP	Z127024	26,13
2" BSP	Z127032	36,54

Welding nipple BSP 60°

Cono ajuste BSP 60°

Schweißnippel DK 60 Dichtkegel 60°

Collet à souder BSP cône 60°



ROSCA THREAD	Referencia Part n°	€
1/4" BSP	Z127304	4,47
3/8" BSP	Z127306	4,94
1/2" BSP	Z127308	5,36
3/4" BSP	Z127312	6,94
1" BSP	Z127316	9,47
1"1/4 BSP	Z127320	19,40
1"1/2 BSP	Z127324	35,08
2" BSP	Z127332	49,57

Welding nipple BSP flat seat

Cono ajuste BSP asiento plano

Schweißnippel DK 60 Dichtkegel 60° flachdichtend

Collet à souder BSP fond plat



ROSCA THREAD	Ø EXT. Ø OUTER	Referencia Part n°	€
1"1/4 BSP	33	Z127420	21,97
1"1/4 BSP	33	Z127920	23,15

Until end of stock / Hasta fin de existencias / Bis zum Ende des Lagerbestandes / Jusqu'à la fin du stock

Z127920 with guide / Z127920 con guía. / Z127920 mit Außengewinde / Z127920 avec guide.

Welding nipple for JIC 37° with guide

Cono ajuste JIC 37° con guía

Schweißnippel JIC 37° mit AG

Collet à souder femelle JIC cône 37° avec guide



ROSCA THREAD	DN	Referencia Part n°	€
7/16" 20h UNF	1/4"	Z12770704	8,39
1/2" 20h UNF	1/4"	Z12770804	8,93
9/16" 18h UNF	3/8"	Z12770906	6,78
3/4" 16h UNF	3/8"	Z12771206	7,79
7/8" 14h UNF	5/8"	Z12771410	7,94
1"1/16 12h UN	3/4"	Z12771712	12,26

Until end of stock / Hasta fin de existencias / Bis zum Ende des Lagerbestandes / Jusqu'à la fin du stock

JIC nut

Tuercas JIC

Muttern JIC - M JIC

Écrou JIC



TUBO PIPE	ROSCA THREAD	Referencia Part n°	€
6	1/4"	ZS11006	*
8	5/16"	ZS11008	*
10	3/8"	ZS11010	*
12	1/2"	ZS11012	*
14-15-16	5/8"	ZS11016	*
18-20	-	ZS11020	*
-	3/4"	ZS11020W	*
25	1"	ZS11025	*
30-32	1 1/4"	ZS11032	*
38	1 1/2"	ZS11038	*

*See prices in p.125 (JIC Fittings) / *Ver precios en p.125 (R. JIC) / *Vgl. Sie die Preise auf S. 125 (JIC) / *Prix à la page 125 (R. JIC)

Welding fittings

Racores soldables
Schweißverschraubungen
Embouts à souder

Union 3 fem. welding pieces fig.340hs micro-casting

Unión 3 piezas hembra-soldar FIG.340HS
microfundido

3-teilige Schweißversch. w FIG. 340hs Mikroguss

Union 3 pcs fem. à souder fig.340hs inox acier
moulé



ROSCA THREAD	Referencia Part n°	€
1/4"	ZFIG34004HS	*
3/8"	ZFIG34006HS	*
1/2"	ZFIG34008HS	*
3/4"	ZFIG34012HS	*
1"	ZFIG34016HS	*
1" 1/4	ZFIG34020HS	*
1" 1/2	ZFIG34024HS	*
2"	ZFIG34032HS	*

*See prices p.232 / *Ver precios en p.232 / *Vgl. Sie die Preise auf S. 232 / *Voir prix p.232

Union 3 welding male pieces fig.341ms micro-casting

Unión 3 piezas macho-soldar FIG.341MS
microfundido

3-teilige Schweißversch. m FIG. 341ms Mikroguss

Union 3 pcs mâle à souder fig.341ms inox acier
moulé



ROSCA THREAD	Referencia Part n°	€
1/4"	ZFIG34104MS	*
3/8"	ZFIG34106MS	*
1/2"	ZFIG34108MS	*
3/4"	ZFIG34112MS	*
1"	ZFIG34116MS	*
1" 1/4	ZFIG34120MS	*
1" 1/2	ZFIG34124MS	*
2"	ZFIG34132MS	*

*See prices p.232 / *Ver precios en p.232 / *Vgl. Sie die Preise auf S. 232 / *Voir prix p.232

Union 3 welding pieces fig. 340s micro-casting

Unión 3 piezas soldar FIG.340S microfundido

3-teilige Schweißversch. FIG. 340s Mikroguss

Union 3 pièces à souder fig. 340s inox acier moulé



ROSCA THREAD	Referencia Part n°	€
1/4"	ZFIG34004S	*
3/8"	ZFIG34006S	*
1/2"	ZFIG34008S	*
3/4"	ZFIG34012S	*
1"	ZFIG34016S	*
1" 1/4	ZFIG34020S	*
1" 1/2	ZFIG34024S	*
2"	ZFIG34032S	*

*See prices p.232 / *Ver precios en p.232 / *Vgl. Sie die Preise auf S. 232 / *Voir prix p.232

Welding flanges

Bridas soldables

Schweißflansche

Brides à souder

Welding forged flange DIN 2633 PN 10/16

Brida fija soldable PN10/16 DIN 2633

Vorschweißflansch DIN 2633 PN 10/16

Bride fixe à souder DIN 2633 PN10/16



DN	Referencia Part n°	€
15-1/2"	ZBPN16263308	44,68
20-3/4"	ZBPN16263312	55,43
25-1"	ZBPN16263316	66,11
32-1"1/4	ZBPN16263320	91,90
40-1"1/2	ZBPN16263324	94,42
50-2"	ZBPN16263332	125,79
65-2"1/2	ZBPN16263340	143,80
80-3"	ZBPN16263348	176,41
100-4"	ZBPN16263364	223,68

Welding forged flange DIN 2635 PN 40

Brida fija soldable PN40 DIN 2635

Vorschweißflansch DIN 2635 PN 40

Bride fixe à souder DIN 2635 PN 40



DN	Referencia Part n°	€
13-3/8"	ZBPN40263506*	45,71
15-1/2"	ZBPN40263508	44,68
20-3/4"	ZBPN40263512	71,20
25-1"	ZBPN40263516	66,11
32-1"1/4	ZBPN40263520	87,26
40-1"1/2	ZBPN40263524	109,47
50-2"	ZBPN40263532	132,50
65-2"1/2	ZBPN40263540	175,72
80-3"	ZBPN40263548	220,46
100-4"	ZBPN40263564	310,74

*Until end of stock / Hasta fin de existencias / Bis zum Ende des Lagerbestandes / Jusqu'à la fin du stock

Flange ANSI-ASA Welding Neck 150 LBS

Brida fija ANSI-ASA 150 LBS

Flansch ANSI-ASA W.NECK 150 LBS

Bride ANSI-ASA Welding Neck 150 LBS



DN	Referencia Part n°	€
15-1/2"	ZBANSAWN15008	36,51
20-3/4"	ZBANSAWN15012	37,61
25-1"	ZBANSAWN15016	53,09
32-1"1/4	ZBANSAWN15020	68,12
40-1"1/2	ZBANSAWN15024	85,43
50-2"	ZBANSAWN15032	126,03
65-2"1/2	ZBANSAWN15040	200,09
80-3"	ZBANSAWN15048	247,12
100-4"	ZBANSAWN15064	332,45

FLANGE ANSI-ASA Welding Neck 300 LBS

Brida fija ANSI-ASA 350 LBS

Flansch ANSI-ASA W.NECK 300 LBS

Bride ANSI-ASA Welding Neck 300 LBS



DN	Referencia Part n°	€
15-1/2"	ZBANSAWN30008	47,87
20-3/4"	ZBANSAWN30012	98,25
25-1"	ZBANSAWN30016	89,26
32-1"1/4	ZBANSAWN30020	112,20
40-1"1/2	ZBANSAWN30024	147,53
50-2"	ZBANSAWN30032	241,65
65-2"1/2	ZBANSAWN30040	251,14
80-3"	ZBANSAWN30048	332,02
100-4"	ZBANSAWN30064	539,38

Welding flanges

Bridas soldables
Schweißflansche
Brides à souder

Welding forged slip on flange DIN 2642 PN 10

Brida loca PN10 DIN 2642

Vorschweißflansch DIN 2642 PN 10



Bride tournante à souder DIN 2642 PN 10

DN	Referencia Part n°	€
15-1/2"	ZBPN10264208	37,54
20-3/4"	ZBPN10264212	38,64
25-1"	ZBPN10264216	59,27
32-1"1/4	ZBPN10264220	70,61
40-1"1/2	ZBPN10264224	82,72
50-2"	ZBPN10264232	111,72
65-2"1/2	ZBPN10264240	134,04
80-3"	ZBPN10264248	185,10
100-4"	ZBPN10264264	228,50

Ring for flange DIN 2642

Aro para brida DIN 2642

Ring für Flansche DIN 2642



Collet épais pour bride DIN 2642

DN	Referencia Part n°	€
1/2"	ZABARO264208	13,85
3/4"	ZABARO264212	30,23
1"	ZABARO264216	38,98
1"1/4	ZABARO264220	48,59
1"1/2	ZABARO264224	60,12
2"	ZABARO264232	46,32
2"1/2	ZABARO264240	150,02
3"	ZABARO264248	243,48
4"	ZABARO264264	239,02

Tube for welding flanges ANSI-DIN

Tubo para soldar bridas ANSI-DIN

Rohr für Schweißflansche ANSI-DIN



Tube à souder brides ANSI-DIN

DN	Referencia Part n°	€
3/8"	ZBTUB006	6,39
1/2"	ZBTUB008	10,33
3/4"	ZBTUB012	8,81
1"	ZBTUB016	9,72
1"1/4	ZBTUB020	16,17
1"1/2	ZBTUB024	16,56
2"	ZBTUB032	21,67
2"1/2	ZBTUB040	21,27
3"	ZBTUB048	29,82
4"	ZBTUB064	40,19

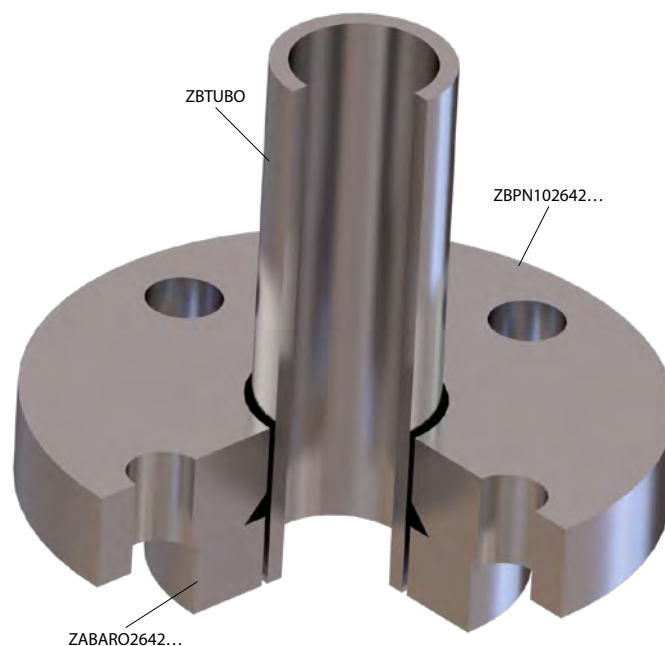

Welding flanges

Bridas soldables
Schweißflansche
Brides à souder

Welding forged flange DIN 2656 PN 40

Brida plana PN40 DIN 2656

Vorschweißflansch DIN 2656 PN 40

Bride tournante à souder DIN 2656 PN 40



DN	Referencia Part n°	€
15-1 1/2"	ZBPN40265608	57,73
20-3/4"	ZBPN40265612	38,68
25-1"	ZBPN40265616	74,01
32-1 1/4"	ZBPN40265620	76,56
40-1 1/2"	ZBPN40265624	93,65
50-2"	ZBPN40265632	177,87
65-2 1/2"	ZBPN40265640	169,28
80-3"	ZBPN40265648	187,02
100-4"	ZBPN40265664	209,32

Ring for flange DIN 2656

Aro para brida DIN 2656

Ring für Flansche DIN 2656

Collet épais pour brida DIN 2656



DN	Referencia Part n°	€
1/2"	ZABARO265608	16,00
3/4"	ZABARO265612	32,40
1"	ZABARO265616	41,75
1 1/4"	ZABARO265620	49,84
1 1/2"	ZABARO265624	68,83
2"	ZABARO265632	99,52
2 1/2"	ZABARO265640	169,00
3"	ZABARO265648	168,13

Tube for welding flanges ANSI-DIN

Tubo para soldar bridas ANSI-DIN

Rohr für Schweißflansche ANSI-DIN

Tube à souder brides ANSI-DIN



DN	Referencia Part n°	€
3/8"	ZBTUBO06	6,39
1/2"	ZBTUBO08	10,33
3/4"	ZBTUBO12	8,81
1"	ZBTUBO16	9,72
1 1/4"	ZBTUBO20	16,17
1 1/2"	ZBTUBO24	16,56
2"	ZBTUBO32	21,67
2 1/2"	ZBTUBO40	21,27
3"	ZBTUBO48	29,82
4"	ZBTUBO64	40,19

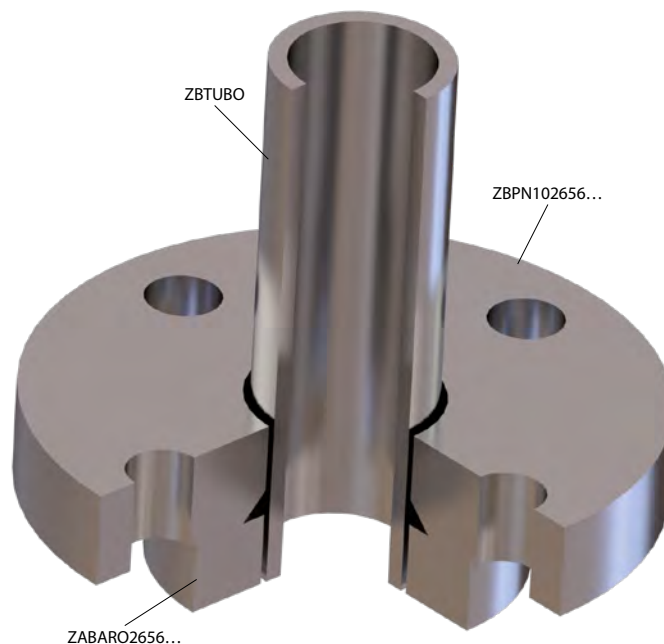

Welding flanges

Bridas soldables
Schweißflansche
Brides à souder

Swivel flange ANSI-ASA 150 LBS

Brida plana ANSI-ASA 150 LBS

Flansch ANSI-ASA 150 LBS

Bride tournante ANSI-ASA 150 LBS



DN	Referencia Part n°	€
15-1/2"	ZBANSASO15008	28,91
20-3/4"	ZBANSASO15012	26,85
25-1"	ZBANSASO15016	43,21
32-1"1/4	ZBANSASO15020	46,09
40-1"1/2	ZBANSASO15024	62,11
50-2"	ZBANSASO15032	96,39
65-2"1/2	ZBANSASO15040	143,48
80-3"	ZBANSASO15048	183,55
100-4"	ZBANSASO15064	246,42

Swivel flange ANSI-ASA 300 LBS

Brida plana ANSI-ASA 300 LBS

Flansch ANSI-ASA 300 LBS

Bride tournante ANSI-ASA 300 LBS



DN	Referencia Part n°	€
15-1/2"	ZBANSASO30008	52,94
20-3/4"	ZBANSASO30012	50,80
25-1"	ZBANSASO30016	93,58
32-1"1/4	ZBANSASO30020	126,17
40-1"1/2	ZBANSASO30024	116,58
50-2"	ZBANSASO30032	135,97
65-2"1/2	ZBANSASO30040	218,57
80-3"	ZBANSASO30048	445,90
100-4"	ZBANSASO30064	712,87

Ring for flange ANSI-ASA

Aro para brida ANSI-ASA

Ring für Flansche ANSI-ASA

Collet épais pour bride ANSI-ASA



DN	Referencia Part n°	€
1/2"	ZABAROANSA08	6,82
3/4"	ZABAROANSA12	8,92
1"	ZABAROANSA16	10,69
1"1/4	ZABAROANSA20	15,50
1"1/2	ZABAROANSA24	20,85
2"	ZABAROANSA32	53,88
2"1/2	ZABAROANSA40	53,71
3"	ZABAROANSA48	59,61
4"	ZABAROANSA64	85,18

Tube for welding flanges ANSI-DIN

Tubo para soldar bridas ANSI-DIN

Rohr für Schweißflansche ANSI-DIN

Tube à souder brides ANSI-DIN



DN	Referencia Part n°	€
3/8"	ZBTUBO06	6,39
1/2"	ZBTUBO08	10,33
3/4"	ZBTUBO12	8,81
1"	ZBTUBO16	9,72
1"1/4	ZBTUBO20	16,17
1"1/2	ZBTUBO24	16,56
2"	ZBTUBO32	21,67
2"1/2	ZBTUBO40	21,27
3"	ZBTUBO48	29,82
4"	ZBTUBO64	40,19

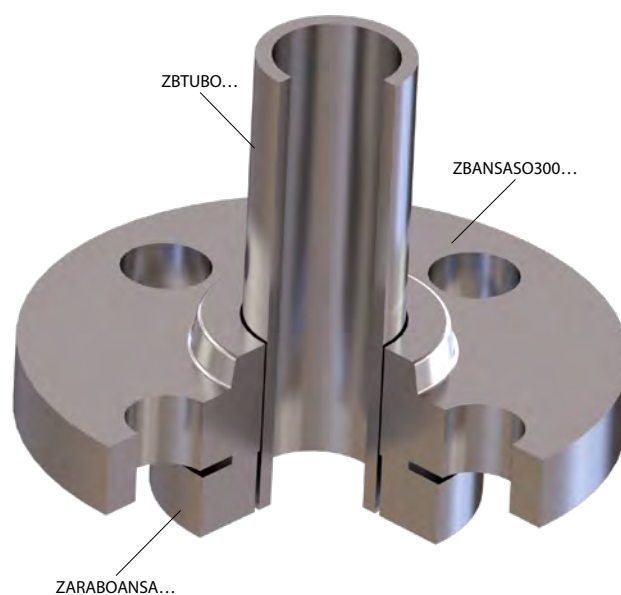
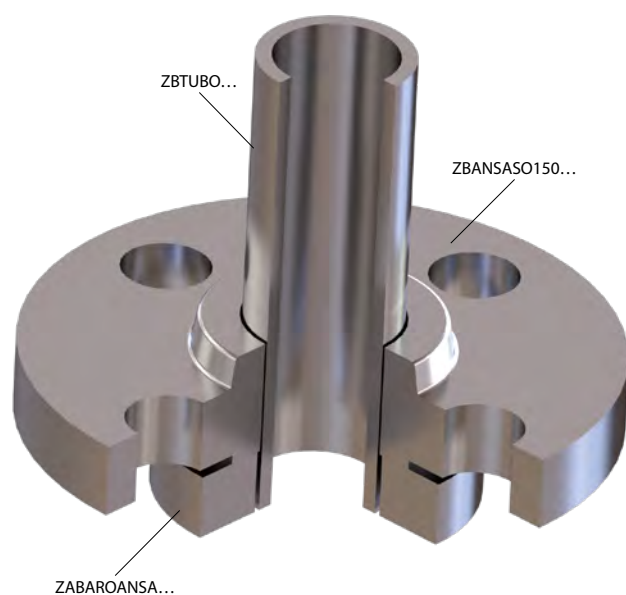

DICSA

Servicio Integral para hacer Crecer tu Negocio.



Complete Service to make your business grow



Fabricación - Manufacture
Logística - Logistics
Área Calidad - Quality Department
Área Técnica - Technical Department
Taller Hidráulica - Hydraulic Workshop
Taller Latiguillos - Hose Assembly Workshop
Taller Soldadura - Welding Workshop
Servicios Comerciales - Commercial Services
Plataforma Digital - Digital Platform

www.dicsaes.com

Food industry fittings 213

Racores industria alimentaria
Kupplungen für Lebensmittelindustrie
Raccords alimentaires

DIN 2828 Camlock Fittings 221

Serie Camlock DIN 2828
CAMLOCK AISI 316 - DIN 2828
Raccords Camlock DIN 2828

GUILLEMIN NF E-29572 Fittings 225

Acoples GUILLEMIN NF E-29572
Kupplungen GUILLEMIN NF E-29572
Raccords GUILLEMIN NF E-29572

TW (Tankwagen) DIN 28450 Fittings 227

Acoples TW (Tankwagen) DIN 28450
Kupplungen TW (Tankwagen) DIN 28450
Raccords TW (Tankwagen) DIN 28450

Stainless Steel accessories for industrial fitting 228

Accesorios inox para racor industrial
Edelstahl-Zubehör für Industriekupplungen
Accessoires acier inox pour raccord industriel

Screw low pressure fittings 150 LBS 229

Racores baja presión 150 LBS
Niederdruck-Armaturen 150 lbs
Raccords basse pression 150 LBS



06

INDUSTRIAL FITTINGS

Racores industriales

Industriekupplungen

Raccords industriels

Food industry fittings

Racores industria alimentaria
Kupplungen für Lebensmittelindustrie
Raccords alimentaires

Crimping ferrules ▪ Casquillos para prensar ▪ Pressfassungen ▪ Jupes à sertir

213



81042

SMS Unions ▪ Racores SMS ▪ SMS-Armaturen ▪ Raccords SMS

214



ZRA200



ZRA212



ZSMS H



ZSMS S



ZSMS M



Z SMS BN



JSMSS



JSMSP

Clamp Unions ▪ Racores Tri-Clamp ▪ TRI-CLAMP-Armaturen ▪ Raccords Tri-Clamp

216



ZTC



ZC



JCLAMPS



JCLAMPP



ZAC1P



ZPC

DIN 11851 Unions ▪ Racores DIN 11851 ▪ Verschraubungen Din 11851 ▪ Raccords DIN 11851

217



ZRA100



ZRA112



ZDIN H



Z DIN BN



ZDIN S



ZDIN M



JDINS



JDINP

Macon Unions ▪ Racores Macon ▪ Verschraubungen Macon ▪ Raccords Macon

218



ZRA300



ZRA312



ZMAC H

Food industry fittings for PTFE hose STD Series ▪ Racores alimentarios para manguera PTFE Serie STD ▪ Lebensmittelarmaturen für PTFE Serie STD ▪ Raccords alimentaires pour tuyau PTFE Série STD

219



ZRA250



ZRA150



ZRA252



ZRA152



ZTCS



81040



81041

RJT Fittings ▪ Racores RJT ▪ RJT Armaturen ▪ Raccords RJT

220



ZRJT H



ZRJT M



ZRJT WL



JRJT NBR

DIN 2828 Camlock Fittings

Serie Camlock DIN 2828
CAMLOCK AISI 316 - DIN 2828
Raccords Camlock DIN 2828

Camlock Unions AISI 316 ▪ Racores Camlock AISI 316 ▪ CAMLOCK AISI 316 ▪ Raccords Camlock AISI 316

221



Serie Autolock AISI 316

Autolock Unions AISI 316
AUTOLOCK AISI 316
Raccords Autolock AISI 316

Autolock Unions AISI 316 ▪ Racores Autolock AISI 316 ▪ AUTOLOCK AISI 316 ▪ Raccords Autolock AISI 316

224



GUILLEMIN NF E-29572 Fittings

Acoples GUILLEMIN NF E-29572
Kupplungen GUILLEMIN NF E-29572
Raccords GUILLEMIN NF E-29572

GUILLEMIN Stainless Steel ▪ GUILLEMIN inox ▪ GUILLEMIN Edelstahl ▪ GUILLEMIN acier inox

225

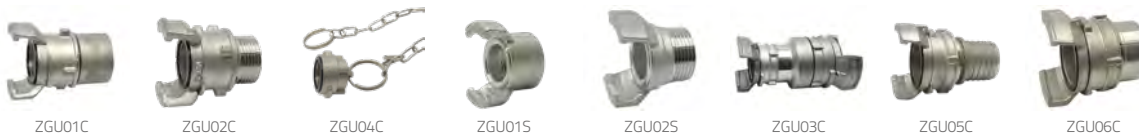

TW (Tankwagen) DIN 28450 Fittings

Acoples TW (Tankwagen) DIN 28450
Kupplungen TW (Tankwagen) DIN 28450
Raccords TW (Tankwagen) DIN 28450

TW Stainless Steel ▪ TW (Tankwagen) inox ▪ TW Edelstahl ▪ TW acier inox

227



Stainless Steel accessories for industrial fitting

Accesorios inox para racor industrial
Edelstahl-Zubehör für Industriekupplungen
Accessoires acier inox pour raccord industriel

Stainless Steel Crimping Ferrule for industrial fitting ▪ Campana inox para racor industrial ▪ Edelstahl-Hülse für Industriekupplungen ▪ Jupe pour raccord industriel acier inox | 228



ZCA

Stainless Steel clamp for industrial fitting ▪ Abrazadera inox para racor industrial ▪ Edelstahl-Schelle für Industriekupplung ▪ Collier pour raccord industriel acier inox | 228



ZAB01



ZAB02

Screw low pressure fittings 150 LBS

Racores baja presión 150 LBS
Niederdruck-Armaturen 150 lbs
Raccords basse pression 150 LBS

Screwed fittings low pressure 150 LBS ▪ 150 LBS Microfundido ▪ Niederdruck-Armaturen 150 lbs ▪ Adapteurs basse pression 150 LBS | 229



Welding fittings low pressure 150 LBS ▪ 150 LBS Soldables ▪ Niederdruck-Schweißarmaturen 150 LBS ▪ Raccords à souder basse pression 150 LBS | 232



ZFIG340...HS

ZFIG340...S

ZFIG341...MS

150 LBS fittings Valves ▪ 150 LBS Válvulas ▪ 150 LBS-Armaturen-Ventile ▪ Raccords Vannes 150 LBS | 233



BP2V3P

BP2V

Food industry fittings

Racores industria alimentaria
Kupplungen für Lebensmittelindustrie
Raccords alimentaires

Food industry hoses ferrules

Casquillos para mangueras alimentarias

Pressfassungen für Lebensmittelschläuche

Jupes à sertir tuyaux alimentaires



DN	Ø MANGUERA Ø HOSE	Referencia Part n°	€
13-1/2"	23	810421324	15,97
19-3/4"	32	810421933	20,43
25-1"	39	810422540	24,86
32-1 1/4"	48	810423248	36,26
38-1 1/2"	52	810423852	49,07
38-1 1/2"	56	810423857	61,90
40-1 1/2"	54	810424055	53,97
40-1 1/2"	60	810424061	62,08
50-2"	63	810425064	66,98
50-2"	68	810425069	86,74
50-2"	73	810425073	89,55
65-2 1/2"	79	810426580	92,31
65-2 1/2"	93	810426593	150,48
70-3"	89	810427090	190,39
75-3"	94	810427595	139,03
75-3"	106	8104275107	256,89
100-4"	122	81042100123	235,53
100-4"	134	81042100135	319,79



FOOD INDUSTRY HOSES | MANGUERAS ALIMENTARIAS



Hoses suitable for suction and discharge:
Milk, wine, oils, fatty foods, alcohol drinks (max 40%), etc./

Mangueras aptas para productos alimentarios de aspiración e impulsión:

Leche, vino, aceites, alimentos grasos, bebidas alcohol (máx. 40%), etc.

Ver precios en Catálogo Conducciones. | See prices in Connectors Catalogue.



Food industry fittings

Racores industria alimentaria
Kupplungen für Lebensmittelindustrie
Raccords alimentaires

Swivel female SMS

Hembras giratorias SMS

Dichtkopf mit Ü-Mutter SMS

Raccord femelle tournante SMS



ROSCA THREAD	DN	Referencia Part n°	€
40x1/6"	25	ZRA2004025	37,10
48x1/6"	32	ZRA2004832	58,40
60x1/6"	38	ZRA2006038	76,82
60x1/6"	40	ZRA2006040	86,51
70x1/6"	50	ZRA2007050	104,89
85x1/6"	63	ZRA2008563	184,74
85x1/6"	65	ZRA2008565	171,98
98x1/6"	70	ZRA2009870	273,09
98x1/6"	75	ZRA2009875	257,22
98x1/6"	80	ZRA2009880	339,53
125x1/4"	100	ZRA200125100	354,91
132x1/4"	100	ZRA200132100	433,11

Fixed male SMS

Machos fijos SMS

Außengewinde SMS

Raccord mâle SMS



ROSCA THREAD	DN	Referencia Part n°	€
40x1/6"	25	ZRA2124025	44,50
48x1/6"	32	ZRA2124832	72,05
60x1/6"	38	ZRA2126038	84,53
60x1/6"	40	ZRA2126040	78,71
70x1/6"	50	ZRA2127050	161,02
85x1/6"	63	ZRA2128563	182,05
85x1/6"	65	ZRA2128565	167,24
98x1/6"	70	ZRA2129870	359,82
98x1/6"	75	ZRA2129875	309,60
98x1/6"	80	ZRA2129880	359,94
125x1/4"	100	ZRA212125100	320,83
132x1/4"	100	ZRA212132100	492,82

Nuts SMS

Tuercas SMS

Muttern SMS

Écrou SMS



ROSCA THREAD	DN	Referencia Part n°	€
40x1/6"	25	ZSMS H 25	17,21
48x1/6"	32	ZSMS H 32	16,02
60x1/6"	38	ZSMS H 38	19,54
70x1/6"	51	ZSMS H 51	27,88
85x1/6"	63	ZSMS H 63	43,05
98x1/6"	76	ZSMS H 76	56,63
125x1/4"	104	ZSMS H 104	69,45
132x1/4"	104	ZSMS H 105	69,45

Liner to weld SMS

Conos soldables SMS

Schweißkegel SMS

Douilles à souder SMS



DN	Referencia Part n°	€
25	ZSMS S 25	7,48
32	ZSMS S 32	9,24
38	ZSMS S 38	15,08
51	ZSMS S 51	28,33
63	ZSMS S 63	47,36
76	ZSMS S 76	53,27
104	ZSMS S 104	71,83

Weld male SMS

Machos soldables SMS

Schweiß-Außengewinde SMS

Nez à souder SMS



ROSCA THREAD	DN	Referencia Part n°	€
40x1/6"	25	ZSMS M 25	15,51
48x1/6"	32	ZSMS M 32	17,92
60x1/6"	38	ZSMS M 38	15,56
70x1/6"	51	ZSMS M 51	18,60
85x1/6"	63	ZSMS M 63	29,16
98x1/6"	76	ZSMS M 76	29,49
125x1/4"	104	ZSMS M 104	42,68

Food industry fittings

Racores industria alimentaria
Kupplungen für Lebensmittelindustrie
Raccords alimentaires

Blind round nut SMS

Tapones SMS

Blindrundmutter SMS

Ecrou Bouchon Avec Chainette



DN	ROSCA THREAD	Referencia Part n°	€
25	40X1/6"	Z SMS BN 25	19,70
38	60X1/6"	Z SMS BN 38	35,96
51	70X1/6"	Z SMS BN 51	43,86
63	85X1/6"	Z SMS BN 63	65,13
76	98X1/6"	Z SMS BN 76	87,92
104	125X1/4"	Z SMS BN 104	112,49

Silicone joint for SMS

Junta SMS silicona

Silikon-Dichtring SMS

Joint silicône pour SMS



DN	Referencia Part n°	€
25	JSMSS 25	2,58
32	JSMSS 32	3,20
38	JSMSS 38	3,64
51	JSMSS 51	4,00
63	JSMSS 63	5,33
76	JSMSS 76	5,90
104	JSMSS 104	6,84

PTFE Joint for SMS

Juntas SMS PTFE

PTFE-Dichtringe SMS

Joint PTFE pour SMS



DN	Referencia Part n°	€
25	JSMSP 25	9,78
32	JSMSP 32	12,05
38	JSMSP 38	18,55
51	JSMSP 51	15,24
63	JSMSP 63	16,47
76	JSMSP 76	30,08

CRIMPING FITTINGS
FOR HOSES

PIPE
FITTINGS

PIPE
FITTINGS II

ADAPTOPS

WELDING
FITTINGS

INDUSTRIAL
FITTINGS

ACCESSORIES

CONTROL
COMPONENTS

FLOW
MEASURING

TRALE LOK

Food industry fittings

Racores industria alimentaria
Kupplungen für Lebensmittelindustrie
Raccords alimentaires

Tri-Clamp ISO 2852

Tri-Clamp ISO 2852

Spannringskupplung TRI-CLAMP ISO 2852

Raccord Tri-Clamp ISO 2852

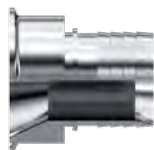

∅	DN	Referencia Part n°	€
25	12	ZTC2512	18,26
25	19	NEW ZTC2519	20,71
34	12	ZTC3412	29,92
34	19	ZTC3419	35,38
50,5	19	ZTC5019	41,31
50,5	25	ZTC5025	38,86
50,5	32	ZTC5032	44,58
50,5	38	ZTC5038	49,04
50,5	40	ZTC5040	55,69
64	38	ZTC6438	75,42
64	40	ZTC6440	74,26
64	50	ZTC6450	83,87
77,5	50	ZTC7750	128,82
77,5	65	ZTC7763	158,49
91	65	ZTC9165	191,40
91	75	ZTC9175	227,67

Welding Tri-Clamp for pipe

Tri-Clamp para soldar en tubo

TRI-CLAMP zum Rohr-Schweißen

Raccord Tri-Clamp à souder pour tube



∅	DN	Referencia Part n°	€
25	12	ZC25-12	9,19
34	12	ZC34-12	10,24
34	18	ZC34-18	10,24
50,5	18	ZC50-18	14,92
50,5	25	ZC50-25	9,54
50,5	33,7	ZC50-33,7	11,31
50,5	38	ZC50-38	10,03
64	38	ZC64-38	16,85
64	51	ZC64-51	13,23
91	65	ZC91-65	26,45

Joint for silicone clamp

Juntas para Clamp Silicona

Dichtring für Schelle Silikon

Joint pour clamp silicône



∅	Referencia Part n°	€
25	JCLAMPS 25	9,74
34	JCLAMPS 34	4,65
50	JCLAMPS 50	4,50
64	JCLAMPS 64	8,70
77	JCLAMPS 77	17,89
91	JCLAMPS 91	15,70

Joint for PTFE clamp

Juntas para Clamp PTFE

Dichtring für Schelle PTFE

Joint pour clamp PTFE



∅	Referencia Part n°	€
25	JCLAMPP 25	29,94
34	JCLAMPP 34	17,97
50	JCLAMPP 50	12,89
64	JCLAMPP 64	19,20
77	JCLAMPP 77	23,43
91	JCLAMPP 91	37,36

Tri-Clamp with 1 pin

Abrazaderas Tri-clamp con 1 pin

TRI-CLAMP mit 1 pin

Collier Tri-Clamp avec 1 pin



∅	Referencia Part n°	€
25	ZAC1P25	17,01
34	ZAC1P34	16,69
50	ZAC1P50	20,79
64	ZAC1P64	23,80
77	ZAC1P77	28,52
91	ZAC1P91	31,53

Tri-Clamp cover

Tri-Clamp Tapa

TRI-CLAMP Deckel

Tri-Clamp Couvercle



∅	Referencia Part n°	€
25	ZPC25	6,15
34	ZPC34	6,54
50,5	ZPC50	7,75
64	ZPC64	10,25
77,5	ZPC77	15,93
91	ZPC91	26,81

Food industry fittings

Racores industria alimentaria
Kupplungen für Lebensmittelindustrie
Raccords alimentaires

Swivel female DIN 11851

Hembras giratorias DIN 11851

Dichtkopf mit Ü-Mutter DIN 11851

Raccord femelle tournante DIN 11851



ROSCA THREAD	DN	Referencia Part n°	€
44x1/6"	20	ZRA1004420	47,85
52x1/6"	25	ZRA1005225	48,57
58x1/6"	32	ZRA1005832	60,87
65x1/6"	38	ZRA1006538	72,30
65x1/6"	40	ZRA1006540	77,22
78x1/6"	50	ZRA1007850	119,65
95x1/6"	63	ZRA1009563	201,06
95x1/6"	65	ZRA1009565	196,97
110x1/4"	75	ZRA10011075	280,27
110x1/4"	80	ZRA10011080	321,69
130x1/4"	100	ZRA100130100	450,37

Fixed male DIN 11851

Machos fijos DIN 11851

Außengewinde DIN 11851 fest

Raccord mâle DIN 11851



ROSCA THREAD	DN	Referencia Part n°	€
52x1/6"	25	ZRA1125225	75,29
58x1/6"	32	ZRA1125832	81,54
65x1/6"	38	ZRA1126538	125,51
65x1/6"	40	ZRA1126540	120,49
78x1/6"	50	ZRA1127850	153,70
95x1/6"	63	ZRA1129563	244,18
95x1/6"	65	ZRA1129565	240,29
110x1/4"	75	ZRA11211075	354,88
110x1/4"	80	ZRA11211080	344,96
130x1/4"	100	ZRA112130100	516,78

Nuts DIN 11851

Tuercas DIN 11851

Muttern DIN 11851

Écrous DIN 11851



ROSCA THREAD	DN	Referencia Part n°	€
34x1/8"	16	ZDIN H 16	15,64
44x1/6"	20	ZDIN H 20	14,29
52x1/6"	25	ZDIN H 25	16,48
58x1/6"	32	ZDIN H 32	17,87
65x1/6"	40	ZDIN H 40	21,75
78x1/6"	50	ZDIN H 50	27,77
95x1/6"	65	ZDIN H 65	36,93
110x1/4"	80	ZDIN H 80	52,62
130x1/4"	100	ZDIN H 100	61,91

DIN 11851 Blind round nut

Tapones DIN 11851

DIN 11851 Blindrundmutter

DIN 11851 Ecrou Bouchon Avec Chainette



DN	ROSCA	Referencia Part n°	€
20	44X1/6"	Z DIN BN 20	24,57
25	52X1/6"	Z DIN BN 25	28,48
32	58X1/6"	Z DIN BN 32	32,88
40	65X1/6"	Z DIN BN 40	38,50
50	78X1/6"	Z DIN BN 50	50,03
65	95X1/6"	Z DIN BN 65	75,70
80	110X1/4"	Z DIN BN 80	111,19

Liner to weld DIN 11851

Conos soldables DIN 11851

Schweißkegel DIN 11851

Douilles à souder DIN 11851



DN	Referencia Part n°	€
16	ZDIN S 16	13,23
20	ZDIN S 20	13,23
25	ZDIN S 25	14,43
32	ZDIN S 32	16,85
40	ZDIN S 40	19,27
50	ZDIN S 50	21,77
65	ZDIN S 65	40,89
75/80	ZDIN S 80	44,51
100	ZDIN S 100	66,20

Weld male DIN 11851

Machos soldables DIN 11851

Schweiß-Außengewinde DIN 11851

Nez à souder DIN 11851



ROSCA THREAD	DN	Referencia Part n°	€
34x1/8"	16	ZDIN M 16	18,06
44x1/6"	20	ZDIN M 20	18,06
52x1/6"	25	ZDIN M 25	17,27
58x1/6"	32	ZDIN M 32	20,48
65x1/6"	40	ZDIN M 40	22,90
78x1/6"	50	ZDIN M 50	27,48
95x1/6"	65	ZDIN M 65	44,91
110x1/4"	75/80	ZDIN M 80	67,75
130x1/4"	100	ZDIN M 100	74,87

Food industry fittings

Racores industria alimentaria
Kupplungen für Lebensmittelindustrie
Raccords alimentaires

Silicone joint for DIN 11851

Juntas DIN 11851 silicona
Silikon-Dichtring DIN 11851
Joint silicone pour DIN 11851



DN	Referencia Part n°	€
20	JDINS 20	2,40
25	JDINS 25	2,05
32	JDINS 32	3,05
40	JDINS 40	2,66
50	JDINS 50	2,43
65	JDINS 65	3,06
80	JDINS 80	8,31

PTFE Joint for DIN 11851

Juntas DIN 11851 PTFE
PTFE-Dichtring DIN 11851
Joint PTFE pour DIN 11851



DN	Referencia Part n°	€
20	JDINP 20	10,16
25	JDINP 25	11,47
32	JDINP 32	11,11
40	JDINP 40	12,08
50	JDINP 50	14,12
65	JDINP 65	15,50
80	JDINP 80	16,07
100	JDINP 100	25,20

Swivel female Macon

Hembras giratorias Macon
Dichtkopf mit Ü-Mutter MACON
Raccord femelle tournante Macon



ROSCA THREAD	DN	Referencia Part n°	€
M55x3	38	ZRA3005538	84,55
M55x3	40	ZRA3005540	79,86
M67x3	50	ZRA3006750	98,81
M79x3,5	65	ZRA3007965	169,16
M90x3,5	65	ZRA3009065	*
M90x3,5	70	ZRA3009070	186,98
M90x3,5	80	ZRA3009080	146,34
M102x4	80	ZRA30010280	240,38

Male fixe Macon

Machos fijos Macon
Außengewinde MACON
Raccord mâle fixe Macon



ROSCA THREAD	DN	Referencia Part n°	€
M55x3	38	ZRA3125538	*
M55x3	40	ZRA3125540	*
M67x3	50	ZRA3126750	*
M79x3,5	65	ZRA3127965	*
M90x3,5	70	ZRA3129070	*
M90x3,5	80	ZRA3129080	*
M102x4	80	ZRA31210280	*

Macon nuts

Tuercas Macon
Muttern MACON (AISI 316)
Écrous à crans Macon



ROSCA THREAD	DN	Referencia Part n°	€
M55x3	40	ZMAC H 40	25,05
M67x3	50	ZMAC H 50	33,89
M79x3,5	60	ZMAC H 60	26,51
M90x3,5	70	ZMAC H 70	28,88
M102x4	80	ZMAC H 80	37,56
M125x4	100	ZMAC H 100	67,59

Food industry fittings

Racores industria alimentaria
Kupplungen für Lebensmittelindustrie
Raccords alimentaires

Swivel female SMS for PTFE STD Series

Hembras giratorias prensar SMS para PTFE Serie STD

Dichtkopf mit Ü-Mutter SMS für PTFE Serie STD

Femelle tournante SMS pour PTFE Série STD



ROSCA THREAD	DN	Referencia Part n°	€
40x1/6"	1"	ZRA2504016	55,63
48x1/6"	1" 1/4	ZRA2504820	68,97
60x1/6"	1" 1/2	ZRA2506024	104,82
70x1/6"	2"	ZRA2507032	142,29
85x1/6"	2" 1/2	ZRA2508540	214,68

Swivel female DIN 11851 for PTFE hose STD Series

Hembras giratorias DIN 11851 para PTFE Serie STD

Dichtkopf DIN 11851 für 6 kt-Nippel SMS für PTFE hose Serie STD

Raccord femelle tournante DIN 11851 pour PTFE Série STD



ROSCA THREAD	DN	Referencia Part n°	€
52x1/6"	1"	ZRA1505216	78,48
58x1/6"	1" 1/4	ZRA1505820	93,12
65x1/6"	1" 1/2	ZRA1506524	97,90
78x1/6"	2"	ZRA1507832	154,39
95x1/6"	2" 1/2	ZRA1509540	266,64

Fixed male SMS for PTFE hose STD Series

Machos SMS para PTFE Serie STD

Außengewinde SMS für PTFE Serie STD

Raccord mâle SMS pour PTFE Série STD



ROSCA THREAD	DN	Referencia Part n°	€
40x1/6"	1"	ZRA2524016	57,12
48x1/6"	1" 1/4	ZRA2524820	79,23
60x1/6"	1" 1/2	ZRA2526024	99,53
70x1/6"	2"	ZRA2527032	194,36
85x1/6"	2" 1/2	ZRA2528540	206,29

Fixed male DIN 11851 for PTFE hose STD Series

Machos DIN 11851 para PTFE Serie STD

Außengewinde SMS DIN 11851 für PTFE Serie STD

Raccord mâle DIN 11851 pour PTFE Série STD



ROSCA THREAD	DN	Referencia Part n°	€
52x1/6"	1"	ZRA1525216	83,58
78x1/6"	2"	ZRA1527832	195,01
58x1/6"	1" 1/4	ZRA1525820	103,47
65x1/6"	1" 1/2	ZRA1526524	112,97
95x1/6"	2" 1/2	ZRA1529540	299,93

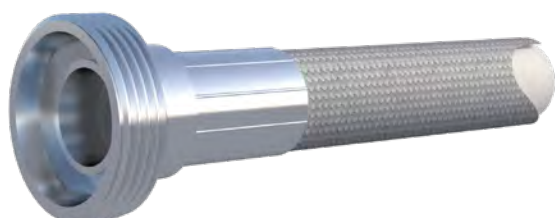

Tri-Clamp Fittings STD Series

Racores Tri-Clamp Serie STD

Dichtkopf TRI-CLAMP Serie STD

Raccords Tri-Clamp Série STD



Ø	DN	Referencia Part n°	€
34	3/8"	ZTCS3406	31,40
50,5	3/4"	ZTCS5012	53,98
50,5	1"	ZTCS5016	56,57
50,5	1" 1/4	ZTCS5020	63,12
50,5	1" 1/2	ZTCS5024	67,27
64	1" 1/2	ZTCS6424	90,25
64	2"	ZTCS6432	116,82
77,5	2"	ZTCS7732	198,69

Ferrules for smooth PTFE

Casquillos PTFE liso

Pressfassungen für PTFE-Glattschläuche

Jupes PTFE lisse



DN	Referencia Part n°	€
1/8"	810400100	*
3/16"	810400300	*
1/4"	810400400	*
5/16"	810400500	*
3/8"	810400600	*
1/2"	810400800	*
5/8"	810401000	*
3/4"	810401200	*
1"	810401600	*

*See prices p.23 / *Ver precios en p.23 / *Vgl. Sie die Preise auf S. 23 / *Voir prix p.23

Ferrules for convoluted PTFE

Casquillos PTFE corrugado

Pressfassungen für PTFE-Wellenschläuche mit Umfl.

Jupes PTFE convoluté



DN	Referencia Part n°	€
1/4"	810410400	*
5/16"	810410500	*
3/8"	810410600	*
1/2"	810410800	*
5/8"	810411000	*
3/4"	810411201	*
1"	810411600	*
1" 1/4	810412000	*
1" 1/2	810412400	*
2"	810413200	*
2" 1/2	810414000	*

*See prices p.23 / *Ver precios en p.23 / *Vgl. Sie die Preise auf S. 23 / *Voir prix p.23

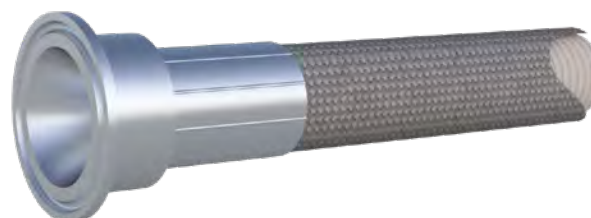

Food industry fittings

Racores industria alimentaria
Kupplungen für Lebensmittelindustrie
Raccords alimentaires

RJT Nuts - 304

NEW

Tuercas RJT - 304

RJT-Muttern -304

Écrous RJT - 304



ROSCA THREAD	DN	Referencia Part n°	€
42.6X1/8	1"	ZRJT H 25	32,20
55.3X1/8	1" 1/2	ZRJT H 38	38,64
68.3X1/6	2"	ZRJT H 51	51,52
80.9X1/6	2" 1/2	ZRJT H 63	58,17
93.6X1/6	3"	ZRJT H 76	65,61
119.1X1/6	4"	ZRJT H 102	96,53
169.6X1/6	6"	ZRJT H 152	248,86

RJT Male

NEW

Macho RJT

RJT-Stecker

RJT Mâle



ROSCA THREAD	DN	Referencia Part n°	€
45.72x8	1"	ZRJT M 25	89,80
58.42x8	1" 1/2	ZRJT M 38	140,32
72.72x6	2"	ZRJT M 51	169,80
85.42x6	2" 1/2	ZRJT M 63	230,12
98.12x6	3"	ZRJT M 76	280,63
123.52x6	4"	ZRJT M 102	535,36
174.32x6	6"	ZRJT M 152	966,76

Welded Liner RJT

NEW

Welded Liner RJT

Geschweißter Liner RJT

Revêtement soudé RJT



DN	Referencia Part n°	€
1"	ZRJT WL 25	44,86
1" 1/2	ZRJT WL 38	77,13
2"	ZRJT WL 51	96,80
2" 1/2	ZRJT WL 63	120,63
3"	ZRJT WL 76	162,77
4"	ZRJT WL 102	290,70
6"	ZRJT WL 152	710,18

NBR RJT Gasket

NEW

Junta NBR RJT

NBR RJT-Dichtung

Joint NBR RJT



DN	Referencia Part n°	€
1"	JRJT NBR 25	4,64
1" 1/2	JRJT NBR 38	6,58
2"	JRJT NBR 51	7,94
2" 1/2	JRJT NBR 63	10,55
3"	JRJT NBR 76	13,08
4"	JRJT NBR 102	15,20
6"	JRJT NBR 152	*

RING JOINT TYPE (RJT)

RENDIMIENTO EXCEPCIONAL
EXCEPTIONAL PERFORMANCE

UK'S MOST POPULAR

Industrias Lácteas, Cerveceras, Alimentaria e Industria General
Dairy, Brewery, Food Processing & General Engineering Industries



+ RJT ESPIGA MANGUERA (consultar)
+ RJT HOSE TAIL (on request)

DIN 2828 Camlock Fittings

Serie Camlock DIN 2828
CAMLOCK AISI 316 - DIN 2828
Raccords Camlock DIN 2828

Male Camlock coupling, female BSP threaded Type A

Camlock macho - rosca hembra BSP Tipo A

Kupplung BSP Typ A

Adapteur mâle Camlock- filetage femelle BSP Type A



DN	ROSCA THREAD	Referencia Part n°	€
12	1/2"	ZA012	6,46
20	1/2"	ZA015	6,37
20	3/4"	ZA020	9,95
25	1"	ZA025	12,66
32	1"1/4	ZA032	16,57
40	1"1/2	ZA040	22,48
50	2"	ZA050	30,19
65	2"1/2	ZA065	41,62
80	3"	ZA080	53,69
100	4"	ZA100	73,66

Female Camlock coupling, female BSP threaded Type D

Camlock hembra - rosca hembra BSP Tipo D

Kupplung BSP TYP D

Adapteur Camlock femelle BSP Type D



DN	ROSCA THREAD	Referencia Part n°	€
12	1/2"	ZD012	14,29
20	1/2"	ZD015	14,18
20	3/4"	ZD020	16,69
25	1"	ZD025	23,01
32	1"1/4	ZD032	34,77
40	1"1/2	ZD040	34,86
50	2"	ZD050	48,87
65	2"1/2	ZD065	59,40
80	3"	ZD080	84,98
100	4"	ZD100	121,60

Female Camlock coupling, female BSPT threaded Type B

Camlock hembra - rosca macho BSPT Tipo B

Kupplung BSPT TYP B

Adapteur Camlock femelle - filetage mâle BSPT Type B



DN	ROSCA THREAD	Referencia Part n°	€
12	1/2"	ZB012	14,66
20	1/2"	ZB015	14,66
20	3/4"	ZB020	15,40
25	1"	ZB025	21,54
32	1"1/4	ZB032	31,77
40	1"1/2	ZB040	32,29
50	2"	ZB050	45,44
65	2"1/2	ZB065	58,46
80	3"	ZB080	82,10
100	4"	ZB100	116,72

Male Camlock coupling, with serrated hose shank Type E

Camlock macho - para manguera Tipo E

Schlauch-Kupplung TYP E

Coupleur Camlock mâle Type E



DN	Referencia Part n°	€
12	ZE012	6,60
20	ZE015	6,60
20	ZE020	9,01
25	ZE025	13,51
32	ZE032	20,38
40	ZE040	25,71
50	ZE050	37,32
65	ZE065	50,57
80	ZE080	83,44
100	ZE100	108,20

Female Camlock coupling with serrated hose shank Type C

Camlock hembra - para manguera Tipo C

Schlauch-Kupplung TYP C

Coupleur Camlock femelle - pour tuyau Type C



DN	Referencia Part n°	€
12	ZC012	13,71
20	ZC015	13,71
20	ZC020	16,83
25	ZC025	22,72
32	ZC032	33,41
40	ZC040	36,64
50	ZC050	46,76
65	ZC065	62,90
80	ZC080	104,10
100	ZC100	128,69

Male Camlock coupling, male BSPT threaded Type F

Camlock macho - rosca macho BSPT Tipo F

Kupplung BSPT TYP F

Adapteur Camlock mâle BSPT Type F



DN	ROSCA THREAD	Referencia Part n°	€
12	1/2"	ZF012	7,56
20	1/2"	ZF015	7,55
20	3/4"	ZF020	9,38
25	1"	ZF025	13,06
32	1"1/4	ZF032	17,53
40	1"1/2	ZF040	27,16
50	2"	ZF050	31,77
65	2"1/2	ZF065	49,58
80	3"	ZF080	64,61
100	4"	ZF100	103,00

DIN 2828 Camlock Fittings

Serie Camlock DIN 2828
CAMLOCK AISI 316 - DIN 2828
Raccords Camlock DIN 2828

Female Camlock Coupling-Dust caps Type DC

Camlock hembra - tapón Tipo DC

Verschluss TYP DC

Bouchon Camlock femelle Type DC



DN	Referencia Part n°	€
12	ZDC012	12,70
20	ZDC020	15,01
25	ZDC025	20,46
32	ZDC032	30,59
40	ZDC040	31,20
50	ZDC050	41,07
65	ZDC065	50,67
80	ZDC080	69,12
100	ZDC100	92,98

Male Camlock coupling-Dust plugs Type DP

Camlock macho - tapón tipo DP

Verschluss TYP DP

Bouchon Camlock mâle Type DP



DN	Referencia Part n°	€
12	ZDP012	5,66
20	ZDP020	6,92
25	ZDP025	9,25
32	ZDP032	13,74
40	ZDP040	15,76
50	ZDP050	22,86
65	ZDP065	37,74
80	ZDP080	46,13
100	ZDP100	72,24

Camlock NBR Seal

Junta Camlock NBR

NBR-Dichtringe für CAMLOCK

Joint Camlock NBR



DN	Referencia Part n°	€
12	JCAMNBR012	0,89
20	JCAMNBR020	0,89
25	JCAMNBR025	1,55
32	JCAMNBR032	1,86
40	JCAMNBR040	2,01
50	JCAMNBR050	3,22
65	JCAMNBR065	4,17
80	JCAMNBR080	3,68
100	JCAMNBR100	6,29

Camlock male - weldable BW

Camlock macho - soldable BW

Kupplung - schweißbar BW

Adapteur Camlock mâle à souder BW



TUBO PIPE	Referencia Part n°	€
21.3	ZABW012	10,06
26.9	ZABW020	11,16
33.7	ZABW025	11,16
42.4	ZABW032	22,96
48.3	ZABW040	27,12
60.3	ZABW050	32,26

Camlock female - weldable BW

Camlock hembra - soldable BW

Kupplung - schweißbar BW

Adapteur Camlock femelle à souder BW



TUBO PIPE	Referencia Part n°	€
21.3	ZDBW012	14,66
26.9	ZDBW020	15,40
33.7	ZDBW025	21,30
42.4	ZDBW032	29,34
48.3	ZDBW040	32,15
60.3	ZDBW050	45,44

Camlock silicone seal

Junta Camlock silicona

Silikon-Dichtring CAMLOCK

Joint Camlock silicone

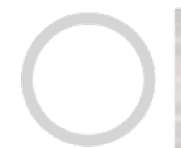

DN	Referencia Part n°	€
12	JCAMS012	2,38
20	JCAMS020	2,38
25	JCAMS025	2,83
32	JCAMS032	4,49
40	JCAMS040	6,03
50	JCAMS050	6,79
65	JCAMS065	7,86
80	JCAMS080	11,74
100	JCAMS100	15,71

DIN 2828 Camlock Fittings

Serie Camlock DIN 2828
CAMLOCK AISI 316 - DIN 2828
Raccords Camlock DIN 2828

Male Camlock coupling, female NPT threaded Type A

Camlock macho - rosca hembra NPT Tipo A

Kupplung NPT Typ A

Adapteur Camlock mâle - filetage femelle NPT Type A



DN	ROSCA THREAD	Referencia Part n°	€
12	1/2"	ZA012NPT	6,37
20	3/4"	ZA020NPT	9,90
25	1"	ZA025NPT	12,91
32	1" 1/4	ZA032NPT	16,11
40	1" 1/2	ZA040NPT	21,96
50	2"	ZA050NPT	30,43
65	2" 1/2	ZA065NPT	41,62
80	3"	ZA080NPT	53,16
100	4"	ZA100NPT	73,71

Female CamlockCoupling, male NPT threaded Type B

Camlock hembra - rosca macho NPT Tipo B

Kupplung NPT Typ B

Adapteur Camlock femelle - filetage mâle NPT Type B



DN	ROSCA THREAD	Referencia Part n°	€
12	1/2"	ZB012NPT	14,66
20	3/4"	ZB020NPT	15,40
25	1"	ZB025NPT	21,30
32	1" 1/4	ZB032NPT	31,73
40	1" 1/2	ZB040NPT	32,15
50	2"	ZB050NPT	45,44
65	2" 1/2	ZB065NPT	58,46
80	3"	ZB080NPT	82,09
100	4"	ZB100NPT	116,72

Female Camlock Coupling, female NPT threaded Type D

Camlock hembra - rosca hembra NPT Tipo D

Kupplung NPT Typ D

Adapteur Camlock femelle NPT Type D



DN	ROSCA THREAD	Referencia Part n°	€
12	1/2"	ZD012NPT	14,18
20	3/4"	ZD020NPT	16,49
25	1"	ZD025NPT	23,46
32	1" 1/4	ZD032NPT	34,57
40	1" 1/2	ZD040NPT	34,05
50	2"	ZD050NPT	47,56
65	2" 1/2	ZD065NPT	59,40
80	3"	ZD080NPT	84,45
100	4"	ZD100NPT	121,60

Male Camlock coupling, male NPT threaded Type F

Camlock macho - rosca macho NPT Tipo F

Kupplung NPT Typ F

Adapteur Camlock mâle NPT Type F



DN	ROSCA THREAD	Referencia Part n°	€
12	1/2"	ZF012NPT	7,55
20	3/4"	ZF020NPT	9,29
25	1"	ZF025NPT	13,04
32	1" 1/4	ZF032NPT	17,52
40	1" 1/2	ZF040NPT	27,12
50	2"	ZF050NPT	31,54
65	2" 1/2	ZF065NPT	49,58
80	3"	ZF080NPT	63,17
100	4"	ZF100NPT	103,00

CAMLOCK NPT



EN 14420-7 | DIN 2828

Ver ficha técnica | Check technical sheet

Para una amplia gama de aplicaciones como agua petróleo y productos químicos
For a wide range of applications such as water, petroleum and chemical liquids

DIN 2828 Camlock Fittings

Serie Camlock DIN 2828
CAMLOCK AISI 316 - DIN 2828
Raccords Camlock DIN 2828

Autolock, female, BSP male threaded Type B

Autolock hembra - rosca macho BSP Tipo B

Autolock Sicherheit TYP B

Autolock femelle - filetage mâle BSP Type B



DN	ROSCA THREAD	Referencia Part n°	€
12	1/2"	ZB012S	27,55
20	3/4"	ZB020S	24,74
25	1"	ZB025S	35,42
32	1"1/4	ZB032S	53,85
40	1"1/2	ZB040S	63,88
50	2"	ZB050S	75,54
65	2"1/2	ZB065S	103,66
80	3"	ZB080S	143,12
100	4"	ZB100S	189,56

Autolock, female, with serrated hose shank Type C

Autolock hembra - para manguera Tipo C

Autolock Sicherheit TYP C

Autolock femelle - pour tuyau Type C



DN	ROSCA THREAD	Referencia Part n°	€
12	1/2"	ZC012S	28,95
20	3/4"	ZC020S	28,11
25	1"	ZC025S	39,41
32	1"1/4	ZC032S	56,44
40	1"1/2	ZC040S	66,14
50	2"	ZC050S	82,80
65	2"1/2	ZC065S	118,69
80	3"	ZC080S	158,42
100	4"	ZC100S	223,18

Autolock, female, BSP female threaded Type D

Autolock hembra - rosca hembra BSP Tipo D

Autolock Sicherheit TYP D

Autolock femelle - filetage femelle BSP Type D



DN	ROSCA THREAD	Referencia Part n°	€
12	1/2"	ZD012S	24,74
20	3/4"	ZD020S	24,74
25	1"	ZD025S	37,08
32	1"1/4	ZD032S	54,75
40	1"1/2	ZD040S	64,65
50	2"	ZD050S	78,99
65	2"1/2	ZD065S	102,87
80	3"	ZD080S	141,71
100	4"	ZD100S	197,32

Autolock, female, DC type dust cap

Autolock hembra - tapón Tipo DC

Autolock Sicherheit TYP DC

Autolock femelle - bouchon Type DC



DN	Referencia Part n°	€
12	ZDC012S	24,31
20	ZDC020S	24,57
25	ZDC025S	32,23
32	ZDC032S	51,40
40	ZDC040S	55,77
50	ZDC050S	71,32
65	ZDC065S	89,83
80	ZDC080S	117,49
100	ZDC100S	157,74

AUTOLOCK



Camlock con cierre de seguridad, múltiples aplicaciones como agua, petróleo y productos químicos

Camlock with security lock, for multiple applications such as water, petroleum and chemical liquids

Ver ficha técnica | Check technical sheet

GUILLEMIN NF E-29572 Fittings

Acoples GUILLEMIN NF E-29572
Kupplungen GUILLEMIN NF E-29572
Raccords GUILLEMIN NF E-29572

GUILLEMIN S.S. with closure-BSP Female thread

GUILLEMIN con cierre-rosca hembra BSP

GUILLEMIN Innengewinde BSP mit Verschluss

GUILLEMIN Inox avec fermeture-Filetage Femelle BSP



DN	ROSCA THREAD	Referencia Part n°	€
20	3/4"	ZGU01C020	28,44
25	1"	ZGU01C025	41,24
32	1" 1/4	ZGU01C032	46,22
40	1" 1/2	ZGU01C040	74,66
50	2"	ZGU01C050	81,08
65	2" 1/2	ZGU01C065	105,27
80	3"	ZGU01C080	153,95
100	4"	ZGU01C100	259,54

GUILLEMIN S.S. with closure-BSP Male thread

GUILLEMIN con cierre-rosca macho BSP

GUILLEMIN Außengewinde BSP mit Verschluss

GUILLEMIN Inox avec fermeture-Filetage Mâle BSP



DN	ROSCA THREAD	Referencia Part n°	€
20	3/4"	ZGU02C020	22,11
25	1"	ZGU02C025	24,89
32	1" 1/4	ZGU02C032	32,00
40	1" 1/2	ZGU02C040	46,22
50	2"	ZGU02C050	77,09
65	2" 1/2	ZGU02C065	103,10
80	3"	ZGU02C080	162,46
100	4"	ZGU02C100	188,43

GUILLEMIN S.S. with closure-Plug

GUILLEMIN con cierre-tapón

GUILLEMIN Verschlussstopfen mit Verschluss

GUILLEMIN Inox avec fermeture-Bouchon



DN	Referencia Part n°	€
20	ZGU04C020	21,33
25	ZGU04C025	22,79
32	ZGU04C032	32,00
40	ZGU04C040	42,75
50	ZGU04C050	53,33
65	ZGU04C065	71,11
80	ZGU04C080	105,30
100	ZGU04C100	177,77

GUILLEMIN S.S. without closure-BSP Female thread

GUILLEMIN sin cierre-rosca hembra BSP

GUILLEMIN Innengewinde BSP ohne Verschluss

GUILLEMIN Inox sans fermeture-Filetage Femelle BSP



DN	ROSCA THREAD	Referencia Part n°	€
20	3/4"	ZGU01S020	18,43
25	1"	ZGU01S025	19,60
32	1" 1/4	ZGU01S032	24,89
40	1" 1/2	ZGU01S040	35,55
50	2"	ZGU01S050	39,11
65	2" 1/2	ZGU01S065	53,33
80	3"	ZGU01S080	88,88
100	4"	ZGU01S100	103,10

GUILLEMIN S.S. without closure-BSP Male thread

GUILLEMIN sin cierre-rosca macho BSP

GUILLEMIN Außengewinde BSP ohne Verschluss

GUILLEMIN Inox sans fermeture-Filetage Mâle BSP



DN	ROSCA THREAD	Referencia Part n°	€
20	3/4"	ZGU02S020	17,78
25	1"	ZGU02S025	21,33
32	1" 1/4	ZGU02S032	27,38
40	1" 1/2	ZGU02S040	27,38
50	2"	ZGU02S050	46,22
65	2" 1/2	ZGU02S065	56,89
80	3"	ZGU02S080	111,81
100	4"	ZGU02S100	117,33

GUILLEMIN S.S. with closure-Reducer

GUILLEMIN con cierre-reductor

GUILLEMIN Reduzierstück mit Verschluss

GUILLEMIN Inox avec fermeture-Réduction



DN	Referencia Part n°	€
40-32	ZGU03C040032	142,21
50-32	ZGU03C050032	132,47
50-40	ZGU03C050040	148,96
65-50	ZGU03C065050	181,32
80-65	ZGU03C080065	273,76
100-80	ZGU03C100080	355,53

GUILLEMIN NF E-29572 Fittings

Acoples GUILLEMIN NF E-29572
Kupplungen GUILLEMIN NF E-29572
Raccords GUILLEMIN NF E-29572

GUILLEMIN S.S. with closure-For hose

GUILLEMIN con cierre-para manguera

GUILLEMIN Für Schlauch mit Verschluss

GUILLEMIN Inox avec fermeture-Pour tuyau



DN	L (mm)	TAMAÑO SIZE	Referencia Part n°	€
40	37	40	ZGU05C040040	39,80
45	37	40	ZGU05C040045	46,22
50	48	50	ZGU05C050050	81,77
50	45,5	50	ZGU05C050055	81,77
65	50	65	ZGU05C065065	110,21
80	70	80	ZGU05C080080	192,72

GUILLEMIN S.S. with closure-Welding

GUILLEMIN con cierre-soldable

GUILLEMIN Schweißarmaturen mit Verschluss

GUILLEMIN Inox avec fermeture-À souder



DN	Referencia Part n°	€
40	ZGU06C040040	46,22
50	ZGU06C050050	75,73
65	ZGU06C065065	103,10
80	ZGU06C080080	156,43

GUILLEMIN



EN 14420-8 | NF E-29572

Ver ficha técnica | Check technical sheet

Aplicaciones de presión y aspiración en un amplio rango de industrias

Pressure and suction purposes in a wide range of industries

TW (Tankwagen) DIN 28450 Fittings

Acoples TW (Tankwagen) DIN 28450
Kupplungen TW (Tankwagen) DIN 28450
Raccords TW (Tankwagen) DIN 28450

TW BSP Female thread - female coupling

TW rosca hembra BSP - acople hembra

TW Innengewinde BSP - Innengewinde Kupplung

TW Filetage Femelle BSP - accouplement Femelle



DN	Referencia Part n°	€
2"	ZMK05032	79,22
3"	ZMK08048	143,66
4"	ZMK10064	291,21

TW BSP Female thread - male coupling

TW rosca hembra BSP - acople macho

TW Innengewinde BSP - Außengewinde Kupplung

TW Filetage Femelle BSP - accouplement Mâle



DN	∅	Referencia Part n°	€
2"	70.5	ZVK05032	34,13
3"	102	ZVK08048	75,08
4"	128	ZVK10064	105,45

TW cap coupling

TW tapón - acople hembra

TW Verschlusskupplung w

TW Bouchon - accouplement Femelle



DN	Referencia Part n°	€
2"	ZMB050	33,86
3"	ZMB080	67,91
4"	ZMB100	111,05

TW Plug - male coupling

TW tapón - acople macho

TW Verschlusskupplung m

TW Bouchon - accouplement Mâle



DN	∅	Referencia Part n°	€
2"	70.5	ZVB050	30,67
3"	102	ZVB080	52,57
4"	128	ZVB100	86,86

TW Female coupling

TW acople hembra

TW Schweißarmaturen - Innengewinde-Kupplung

TW Accouplement Femelle



DN	Referencia Part n°	€
2"	ZMKS050050	104,12
3"	ZMKS080080	203,86

TW Male coupling

TW acople macho

TW-Kupplung m

TW Accouplement Mâle



DN	Referencia Part n°	€
2"	ZVKS050050	61,72
3"	ZVKS080080	144,63

Stainless Steel accessories for industrial fitting

Accesorios inox para racor industrial
Edelstahl-Zubehör für Industriekupplungen
Accessoires acier inox pour raccord industriel

Stainless Steel 304 Crimping Ferrule 45° closure

Campana inox 304 para racor industrial - cierre 45°

Edelstahl-Hülse 45° Verschluss 304

Jupe pour raccord industriel acier inox 304
-fermeture 45°



DN	Ø INT. Ø INNER	Referencia Part n°	€
25	42.5	ZCA025	7,12
32	47	ZCA032	9,79
40	55	ZCA040	10,54
50	64	ZCA050	16,20
65	79	ZCA065	33,49
80	98	ZCA080	43,05
100	120	ZCA100	75,82

Stainless Steel clamp for industrial fitting EN14420-3

Abrazadera EN 14420-3 inox para racor industrial

Edelstahl-Schelle EN14420-3 für
Industriekupplungen

Collier pour raccord industriel acier inox EN 14420-3



Ø MANGUERA Ø HOSE	Ø INT. Ø INNER	Referencia Part n°	€
12	21-25	ZAB01021025	21,83
19	29-33	ZAB01029033	27,71
25	36-39	ZAB01035039	31,37
32	42-46	ZAB01042046	32,22
38	47-51	ZAB01047051	36,05
38	49-53	ZAB01049053	36,05
38	52-56	ZAB01052056	34,35
38	58-62	ZAB01058062	29,08
50	60-64	ZAB01060064	54,23
50	63-67	ZAB01063067	59,64
50	68-72	ZAB01068072	64,41
63	74-77	ZAB01074077	65,46
63	77-81	ZAB01077081	81,01
75	87-90	ZAB01087090	91,82
75	89-94	ZAB01089094	102,50
80	94-98	ZAB01094098	83,90
100	114-119	ZAB01114119	205,73

Stainless steel high pressure clamp W4

Abrazadera alta presión W4 inox

Edelstahl-Hochdruck-Schelle W4 Stahl

Collier haute pression W4 acier inox.



Ø INT. Ø INNER	Referencia Part n°	€
17-19	ZAB02017019	2,76
20-22	ZAB02020022	2,89
23-25	ZAB02023025	2,99
26-28	ZAB02026028	3,02
29-31	ZAB02029031	3,36
32-35	ZAB02032035	3,42
36-39	ZAB02036039	3,58
40-43	ZAB02040043	3,60
44-47	ZAB02044047	3,99
48-51	ZAB02048051	3,99
52-55	ZAB02052055	4,08
56-59	ZAB02056059	4,23
60-63	ZAB02060063	4,32
64-67	ZAB02064067	4,55
68-73	ZAB02068073	6,01
74-79	ZAB02074079	6,28
80-85	ZAB02080085	6,37
86-91	ZAB02086091	6,61
92-97	ZAB02092097	6,69
98-103	ZAB02098103	6,85
104-112	ZAB02104112	7,64
113-121	ZAB02113121	7,33
122-130	ZAB02122130	12,69
131-139	ZAB02131139	13,75
140-148	ZAB02140148	13,34
149-161	ZAB02149161	14,25
162-174	ZAB02162174	17,34
175-187	ZAB02175187	14,67
188-200	ZAB02188200	15,75

Screw low pressure fittings 150 LBS

Racores baja presión 150 LBS
Niederdruck-Armaturen 150 lbs
Raccords basse pression 150 LBS

Nipple fixed male fig.399

Macho fijo espiga FIG.399

Außengewinde Dichtkopf FIG.399 fest

Mâle fixe nipple fig. 399 inox



ROSCA THREAD	DN	Referencia Part n°	€
1/4"	10	ZFIG39904	2,44
3/8"	12	ZFIG39906	3,01
1/2"	15	ZFIG39908	4,26
3/4"	20	ZFIG39912	6,53
1"	25	ZFIG39916	9,37
1" 1/4	32	ZFIG39920	14,35
1" 1/2	40	ZFIG39924	18,74
2"	52	ZFIG39932	25,89

Union male-male fig.150

Unión macho-macho FIG.150

Gerade Verschraubung Fig. 150

Union mâle-mâle fig.150 inox



ROSCA THREAD	Referencia Part n°	€
1/4"	ZFIG15004	2,10
3/8"	ZFIG15006	2,42
1/2"	ZFIG15008	3,77
3/4"	ZFIG15012	4,65
1"	ZFIG15016	6,76
1" 1/4	ZFIG15020	10,23
1" 1/2	ZFIG15024	12,42
2"	ZFIG15032	20,80

Hexagon male plug FIG.290

Tapón macho hexagonal FIG.290

6 kt Stopfen Fig. 290

Bouchon mâle 150 LBS tête hexagonale FIG.290



ROSCA THREAD	Referencia Part n°	€
1/8"	ZFIG29002	1,66
1/4"	ZFIG29004	1,61
3/8"	ZFIG29006	1,91
1/2"	ZFIG29008	2,44
3/4"	ZFIG29012	3,54
1"	ZFIG29016	5,24
1" 1/4	ZFIG29020	8,81
1" 1/2	ZFIG29024	10,64
2"	ZFIG29032	18,02
2" 1/2	ZFIG29040	24,09
3"	ZFIG29048	34,46
4"	ZFIG29060	66,53

Hexagon nipple FIG.280

Adaptador hexagonal FIG.280

6 kt Doppelnippel fig. 280

Mamelon hexagonal 150 LBS FIG.280



ROSCA THREAD	Referencia Part n°	€
1/4"	ZFIG28004	1,89
3/8"	ZFIG28006	2,28
1/2"	ZFIG28008	3,19
3/4"	ZFIG28012	4,83
1"	ZFIG28016	6,88
1" 1/4	ZFIG28020	11,04
1" 1/2	ZFIG28024	13,64
2"	ZFIG28032	19,09
2" 1/2	ZFIG28040	33,80
3"	ZFIG28048	39,28
4"	ZFIG28060	68,03

Reducer male-male fig. 245

Reducción macho-macho FIG.245

Reduziernippel FIG.245

Réduction mâle-mâle fig. 245 inox



ROSCA THREAD	Referencia Part n°	€
1/4"	1/8" ZFIG2450402	1,79
3/8"	1/4" ZFIG2450604	2,37
1/2"	1/4" ZFIG2450804	3,32
1/2"	3/8" ZFIG2450806	3,29
3/4"	3/8" ZFIG2451206	4,33
3/4"	1/2" ZFIG2451208	4,92
1"	1/2" ZFIG2451608	6,64
1"	3/4" ZFIG2451612	7,05
1" 1/4	3/4" ZFIG2452012	9,16
1" 1/4	1" ZFIG2452016	10,62
1" 1/2	1" ZFIG2452416	12,17
1" 1/2	1" 1/4 ZFIG2452420	12,91
2"	1" 1/4 ZFIG2453220	18,14
2"	1" 1/2 ZFIG2453224	19,73
2" 1/2	2" ZFIG2454032	33,38
3"	2" 1/2 ZFIG2454840	49,13

Flat nut fig.312

Tuerca plana FIG.312

Flachmutter FIG. 312

Écrou plat fig.312 inox



ROSCA THREAD	Referencia Part n°	€
1/4"	ZFIG31204	1,47
3/8"	ZFIG31206	1,71
1/2"	ZFIG31208	2,38
3/4"	ZFIG31212	3,06
1"	ZFIG31216	3,45
1" 1/4	ZFIG31220	5,47
1" 1/2	ZFIG31224	8,45
2"	ZFIG31232	10,69

Screw low pressure fittings 150 LBS

Racores baja presión 150 LBS
Niederdruck-Armaturen 150 lbs
Raccords basse pression 150 LBS

Hexagon female cap. FIG.300

Tapón hembra hexagonal FIG.300

6 kt Verschluss m. rd. fig. 300

Bouchon femelle hexagonal 150 LBS FIG.300



ROSCA THREAD	Referencia Part n°	€
1/8"	ZFIG30002	1,62
1/4"	ZFIG30004	1,74
3/8"	ZFIG30006	2,34
1/2"	ZFIG30008	3,19
3/4"	ZFIG30012	4,92
1"	ZFIG30016	7,29
1"1/4	ZFIG30020	10,27
1"1/2	ZFIG30024	13,32
2"	ZFIG30032	19,99
2"1/2	ZFIG30040	29,80
3"	ZFIG30048	38,25
4"	ZFIG30060	62,84

Round female cap. FIG.301

Tapón hembra redondo FIG.301

Verschluss Fig.301

Bouchon femelle ronde 150 LBS FIG.301



ROSCA THREAD	Referencia Part n°	€
1/8"	ZFIG30102	2,00
1/4"	ZFIG30104	1,73
3/8"	ZFIG30106	1,94
3/4"	ZFIG30112	4,03
1"	ZFIG30116	6,52
1"1/4	ZFIG30120	9,37
1"1/2	ZFIG30124	11,53
2"	ZFIG30132	16,60
2"1/2	ZFIG30140	27,29
3"	ZFIG30148	40,18
4"	ZFIG30160	74,76

Until end of stock / Hasta fin de existencias / Bis zum Ende des Lagerbestandes / Jusqu'à la fin du stock

BSP Female coupling DIN 2986 FIG.270

Adaptador hembra BSP DIN 2986 FIG.270

Muffen DIN 2986 Fig. 270

Manchon femelle gaz DIN 2986 150 LBS FIG.270



ROSCA THREAD	Referencia Part n°	€
1/4"	ZFIG27004	2,58
3/8"	ZFIG27006	2,80
1/2"	ZFIG27008	4,46
3/4"	ZFIG27012	4,82
1"	ZFIG27016	9,39
1"1/4	ZFIG27020	12,84
1"1/2	ZFIG27024	14,21
2"	ZFIG27032	21,07
2"1/2	ZFIG27040	35,08
3"	ZFIG27048	44,01
4"	ZFIG27060	78,70

Male-female reducer FIG.241

Reductor macho-hembra FIG.241

Reduzierstück m-w Fig. 241

Réduction 150 LBS MG - FG FIG.241



ROSCA THREAD	R2	Referencia Part n°	€
1/8"	1/4"	ZFIG2410204	1,83
1/4"	3/8"	ZFIG2410406	2,05
1/4"	1/2"	ZFIG2410408	2,85
3/8"	1/2"	ZFIG2410608	2,77
1/2"	3/4"	ZFIG2410812	3,78
3/4"	1"	ZFIG2411216	6,15
3/4"	1"1/4	NEW ZFIG2411220	9,70
1"	1"1/4	ZFIG2411620	9,44
1"	1"1/2	ZFIG2411624	15,38
1"1/4	1"1/2	ZFIG2412024	9,60
1"1/2	2"	ZFIG2412432	17,28
2"	2"1/2	ZFIG2413240	32,89
2"1/2	3"	ZFIG2414048	37,77
3"	4"	ZFIG2414860	73,14

Male square plug FIG.291

Tapón macho cuadrado FIG.291

4 kt Stopfen Fig.291

Bouchon mâle 150 LBS tête carrée FIG.291



ROSCA THREAD	Referencia Part n°	€
1/8"	ZFIG29102	1,82
1/4"	ZFIG29104	1,87
3/8"	ZFIG29106	1,92
1/2"	ZFIG29108	2,43
3/4"	ZFIG29112	3,53
1"	ZFIG29116	4,81
1"1/4	ZFIG29120	7,78
1"1/2	ZFIG29124	9,26
2"	ZFIG29132	18,06
2"1/2	ZFIG29140	22,36
3"	ZFIG29148	31,12
4"	ZFIG29160	53,61

Threaded pipe fig. 531

Tubo roscado FIG.531

Drehstutzen FIG. 531

Tube fileté fig. 531 inox



ROSCA THREAD	Referencia Part n°	€
1/4"	ZFIG53104	2,14
3/8"	ZFIG53106	3,09
1/2"	ZFIG53108	3,11
3/4"	ZFIG53112	3,72
1"	ZFIG53116	5,35
1"1/4	ZFIG53120	7,50
1"1/2	ZFIG53124	8,65
2"	ZFIG53132	12,69

Screw low pressure fittings 150 LBS

Racores baja presión 150 LBS
Niederdruck-Armaturen 150 lbs
Raccords basse pression 150 LBS

Female-female Reducer socket FIG.240

Reducción hembra-hembra FIG.240

Weiblich-weiblich Reduktion Muffen Fig.240

Réduction Femelle-femelle 150 LBS FIG.240



ROSCA THREAD	R2	Referencia Part n°	€
1/4"	1/8"	ZFIG2400402	2,38
3/8"	1/4"	ZFIG2400604	2,23
1/2"	3/8"	ZFIG2400806	3,20
3/4"	1/2"	ZFIG2401208	4,45
1"	3/4"	ZFIG2401612	8,40
1 1/4"	1"	ZFIG2402016	10,66
1 1/2"	1 1/4"	ZFIG2402420	14,94
2"	1 1/2"	ZFIG2403224	18,79
2 1/2"	2"	ZFIG2404032	31,28
3"	2"	ZFIG2404832	47,80
3"	2 1/2"	ZFIG2404840	54,54
4"	2"	ZFIG2406032	76,87

Female-female elbow 90° FIG.090

Codo 90° hembra-hembra FIG.090

90° Winkel 150 lbs FIF. 090

Coude 90° 150 LBS femelle gaz FIG.090



ROSCA THREAD	Referencia Part n°	€
1/8"	ZFIG09002	2,10
1/4"	ZFIG09004	2,50
3/8"	ZFIG09006	3,27
1/2"	ZFIG09008	4,55
3/4"	ZFIG09012	6,98
1"	ZFIG09016	10,14
1 1/4"	ZFIG09020	15,37
1 1/2"	ZFIG09024	16,90
2"	ZFIG09032	26,35
2 1/2"	ZFIG09040	60,17
3"	ZFIG09048	87,91
4"	ZFIG09060	154,41

Female-female elbow 45° FIG.120

Codo 45° hembra-hembra FIG.120

45° Winkel 150 lbs fig.120

Coude 45° 150 LBS FG - FG FIG.120



ROSCA THREAD	Referencia Part n°	€
1/8"	ZFIG12002	2,53
1/4"	ZFIG12004	2,44
3/8"	ZFIG12006	3,06
1/2"	ZFIG12008	4,16
3/4"	ZFIG12012	6,63
1"	ZFIG12016	9,52
1 1/4"	ZFIG12020	16,66
1 1/2"	ZFIG12024	19,50
2"	ZFIG12032	31,53
2 1/2"	ZFIG12040	66,70
3"	ZFIG12048	89,66
4"	ZFIG12060	149,16

Male-female elbow 90° FIG.092

Codo 90° macho-hembra FIG.092

90° Bogen M - FIG. 092

Coude 90° 150 LBS MG - FG FIG.092



ROSCA THREAD	Referencia Part n°	€
1/8"	ZFIG09202	2,50
1/4"	ZFIG09204	2,84
3/8"	ZFIG09206	3,43
1/2"	ZFIG09208	5,07
3/4"	ZFIG09212	6,66
1"	ZFIG09216	11,24
1 1/4"	ZFIG09220	15,26
1 1/2"	ZFIG09224	18,93
2"	ZFIG09232	30,74
2 1/2"	ZFIG09240	62,77
3"	ZFIG09248	95,93
4"	ZFIG09260	183,28

Female-female TEE FIG.130

TE hembra-hembra-hembra FIG.130

Weiblich-weiblich T-Stück 150 lbs FIG. 130

TÉS 150 LBS FG - FG - FG FIG.130



ROSCA THREAD	Referencia Part n°	€
1/8"	ZFIG13002	2,73
1/4"	ZFIG13004	3,40
3/8"	ZFIG13006	4,29
1/2"	ZFIG13008	6,25
3/4"	ZFIG13012	8,79
1"	ZFIG13016	12,26
1 1/4"	ZFIG13020	17,11
1 1/2"	ZFIG13024	22,42
2"	ZFIG13032	37,59
2 1/2"	ZFIG13040	77,24
3"	ZFIG13048	110,41
4"	ZFIG13060	208,90

Threaded cross FIG.180

Cruz roscada FIG.180

Gewinde-Kreuzstück FIG. 180

Croix égale 150 LBS FG FIG.180



ROSCA THREAD	Referencia Part n°	€
1/8"	ZFIG18002	3,75
1/4"	ZFIG18004	5,38
3/8"	ZFIG18006	5,77
1/2"	ZFIG18008	9,37
3/4"	ZFIG18012	14,09
1"	ZFIG18016	19,01
1 1/4"	ZFIG18020	29,29
1 1/2"	ZFIG18024	36,78
2"	ZFIG18032	52,68
2 1/2"	ZFIG18040	98,68
3"	ZFIG18048	211,26
4"	ZFIG18060	248,65

Screw low pressure fittings 150 LBS

Racores baja presión 150 LBS
Niederdruck-Armaturen 150 lbs
Raccords basse pression 150 LBS

Female-female FIG.340

Unión 3 piezas hembra-hembra FIG.340

3-teilige Verschraubung kon i/i 150 lbs FIG. 340

Union 3 pièces 150 LBS FG - FG FIG.340



ROSCA THREAD	Referencia Part n°	€
1/8"	ZFIG34002	6,54
1/4"	ZFIG34004	6,99
3/8"	ZFIG34006	8,54
1/2"	ZFIG34008	10,58
3/4"	ZFIG34012	12,78
1"	ZFIG34016	20,07
1" 1/4	ZFIG34020	28,13
1" 1/2	ZFIG34024	35,10
2"	ZFIG34032	50,80
2" 1/2	ZFIG34040	76,55
3"	ZFIG34048	114,26
4"	ZFIG34060	188,34

Male-female union FIG.341

Unión 3 piezas macho-hembra FIG.341

3-teilige Verschraubung m - w Fig. 341

Union 3 pièces 150 LBS MG - FG FIG.341



ROSCA THREAD	Referencia Part n°	€
1/4"	ZFIG34104	7,55
3/8"	ZFIG34106	8,81
1/2"	ZFIG34108	11,39
3/4"	ZFIG34112	14,85
1"	ZFIG34116	22,69
1" 1/4	ZFIG34120	30,56
1" 1/2	ZFIG34124	36,06
2"	ZFIG34132	57,06
2" 1/2	ZFIG34140	103,54
3"	ZFIG34148	125,96
4"	ZFIG34160	345,61

Welding male fig.149

Macho soldar FIG.149

Schweiß-Außengewinde FIG.149

Mâle à souder fig.149 inox



ROSCA THREAD	Referencia Part n°	€
1/4"	ZFIG14904	1,67
3/8"	ZFIG14906	1,87
1/2"	ZFIG14908	2,59
3/4"	ZFIG14912	3,33
1"	ZFIG14916	4,82
1" 1/4	ZFIG14920	6,87
1" 1/2	ZFIG14924	7,89
2"	ZFIG14932	11,24

Union 3 fem. welding pieces fig.340hs micro-casting

Unión 3 piezas hembra-soldar FIG.340HS
microfundido

3-teilige Schweißversch. w FIG. 340S Mikroguss

Union 3 pcs fem. à souder fig.340hs acier moulé



ROSCA THREAD	Referencia Part n°	€
1/4"	ZFIG34004HS	6,20
3/8"	ZFIG34006HS	10,29
1/2"	ZFIG34008HS	9,92
3/4"	ZFIG34012HS	12,96
1"	ZFIG34016HS	19,78
1" 1/4	ZFIG34020HS	27,28
1" 1/2	ZFIG34024HS	31,92
2"	ZFIG34032HS	50,90

Union 3 welding pieces fig. 340s micro-casting

Unión 3 piezas soldar FIG.340S microfundido

3-teilige Schweißversch. FIG. 340s Mikroguss

Union 3 pièces à souder fig. 340s acier moulé



DN	Referencia Part n°	€
1/4"	ZFIG34004S	7,55
3/8"	ZFIG34006S	8,77
1/2"	ZFIG34008S	9,69
3/4"	ZFIG34012S	12,87
1"	ZFIG34016S	19,81
1" 1/4	ZFIG34020S	26,86
1" 1/2	ZFIG34024S	30,88
2"	ZFIG34032S	49,24

Union 3 welding male pieces fig.341ms micro-casting

Unión 3 piezas macho-soldar FIG.341MS
microfundido

3-teilige Schweißversch. m FIG. 340ms Mikroguss

Union 3 pcs mâle à souder fig.341ms acier moulé



ROSCA THREAD	Referencia Part n°	€
1/4"	ZFIG34104MS	7,29
3/8"	ZFIG34106MS	8,60
1/2"	ZFIG34108MS	11,68
3/4"	ZFIG34112MS	14,74
1"	ZFIG34116MS	22,93
1" 1/4	ZFIG34120MS	29,92
1" 1/2	ZFIG34124MS	36,35
2"	ZFIG34132MS	55,66

Screw low pressure fittings 150 LBS

Racores baja presión 150 LBS
Niederdruck-Armaturen 150 lbs
Raccords basse pression 150 LBS

Ball-valve low pressure full bore 3 pcs

Válvula esfera paso total baja presión 3 piezas

Niederdruck-KH Voller Durchgang - 3 Teile

Robinet basse pression 2 voies boisseau sphérique passage total 3 pcs



ROSCA THREAD	Referencia Part n°	€
1/4" BSP	BP2V3P14INOX	28,45
3/8" BSP	BP2V3P38INOX	28,55
1/2" BSP	BP2V3P12INOX	34,01
3/4" BSP	BP2V3P34INOX	38,07
1" BSP	BP2V3P11INOX	53,76
1" 1/4 BSP	BP2V3P114INOX	96,32
1" 1/2 BSP	BP2V3P112INOX	123,28
2" BSP	BP2V3P21INOX	166,11

Ball-valve low pressure full bore 64 Bar

Válvula esfera paso total baja presión 64 Bar

Niederdruck-KH Voller Durchgang - 64 bar

Robinet basse pression 2 voies boisseau sphérique passage total 64 Bar



ROSCA THREAD	DN	Referencia Part n°	€
1/4" BSP	8	BP2V14INOX	17,77
3/8" BSP	10	BP2V38INOX	16,35
1/2" BSP	15	BP2V12INOX	19,22
3/4" BSP	20	BP2V34INOX	25,44
1" BSP	25	BP2V11INOX	37,14
1"1/4 BSP	32	BP2V114INOX	58,55
1"1/2 BSP	40	BP2V112INOX	84,27
2" BSP	50	BP2V21INOX	118,63
2"1/2 BSP	65	BP2V212INOX	257,72
3" BSP	80	BP2V31INOX	337,82

Quick couplings AISI 316 | 239

Enchufes rápidos AISI 316

SVK AISI 316

Coupleurs rapides AISI 316

Ball valves AISI 316 | 242

Llaves de paso AISI 316

Kugelhähne AISI 316

Robinets AISI 316

Swivel fittings AISI 316 TrΔle® | 245

Racores giratorios AISI 316 TrΔle®

Edelstahl-Drehverschraubungen AISI 316 TrΔle®

Raccords tournants AISI 316 TrΔle®

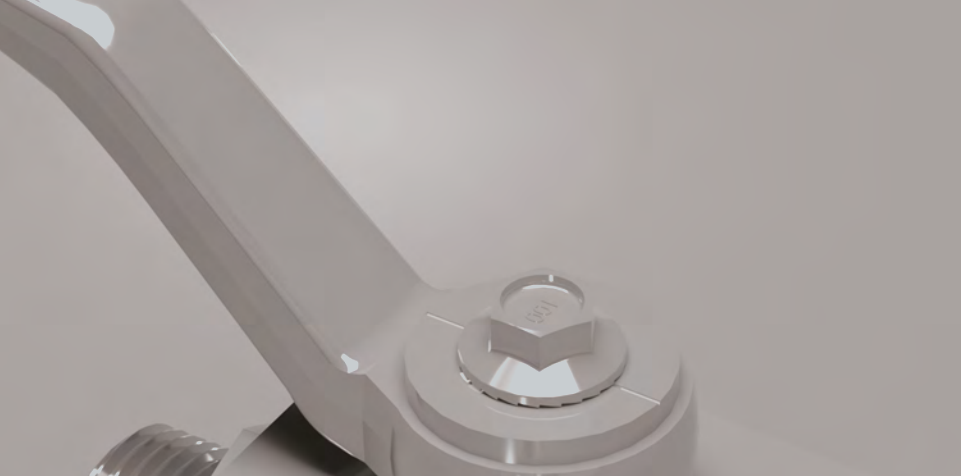

07

| ACCESSORIES

Accesorios

Zubehör

Accessoires

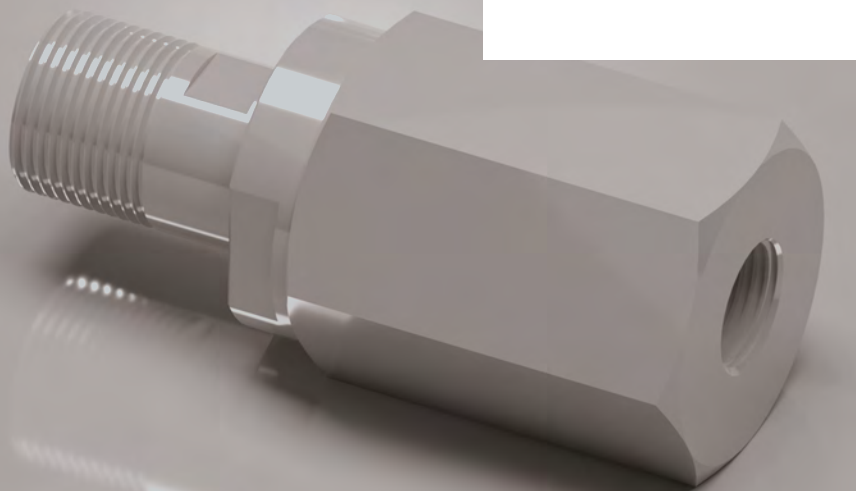

Quick couplings AISI 316

Enchufes rápidos AISI 316

SVK AISI 316

Coupleurs rapides AISI 316

Quick couplings ▪ Enchufes rápidos ▪ SVK ▪ Quick release couplings

| 239



Z8001/Z8002

Z8201/Z8202

Z8008/Z8009

Z8301/Z8302

Z9001/Z9002

Z7111/Z7112

Z9051/Z9052

Quick couplings TrΔle® ▪ Enchufes rápidos TrΔle® ▪ SVK TrΔle® ▪ Coupleurs rapides TrΔle®

| 241



ZB820

ZB800

ZB830

ZB801

ZB811

ZB900

Ball valves AISI 316

Llaves de paso AISI 316

Kugelhähne AISI 316

Robinets AISI 316

Ball valves ▪ Llaves de paso ▪ Kugelhähne ▪ Robinets

242



MKH G

MKH_L

MKH_S

MKH G_DN

MKH_L_DN

MKH_S_DN

MK3A-G

2 ways TrΔle® ball valve ▪ Llave 2 vías TrΔle® ▪ 2-Wege-KH TrΔle® ▪ Robinet 2 voies TrΔle®

244



ZGB2V

ZGB2V NPT

ZGB2V L

ZGB2V S

3 ways TrΔle® ball valve ▪ Llave 3 vías TrΔle® ▪ 3-Wege-KH TrΔle® ▪ Robinet 3 voies TrΔle®

244



ZGB3VH

Handles ▪ Manetas ▪ Handgriff ▪ Leviers

244



Z60013

Swivel fittings AISI 316 TrΔle®

Racores giratorios AISI 316 TrΔle®
Edelstahl-Drehverschraubungen AISI 316 TrΔle®
Raccords tournants AISI 316 TrΔle®

Swivel fittings TrΔle® ▪ Racores giratorios TrΔle® ▪ Drehverschraubungen TrΔle® ▪ Raccords tournants TrΔle®

| 245



Z GGL

Z GG90

Quick couplings AISI 316

Enchufes rápidos AISI 316

SVK AISI 316

Coupleurs rapides AISI 316

Quick coupling ISO 7241-B

Enchufes de punzón ISO 7241-B

SVK nach ISO 7241-B

Coupleurs rapides à clapet ISO 7241-B



ROSCA THREAD	TAMAÑO ISO ISO SIZE	TAMAÑO BG BG SIZE	E. C.	Referencia Part n°	€
1/4" BSP	6,3	1	M	Z800104	43,69
3/8" BSP	10	2	M	Z800106	53,54
1/2" BSP	12,5	3	M	Z800108	71,56
3/4" BSP	20	4	M	Z800112	97,07
1" BSP	25	5	M	Z800116	157,76
1"1/4 BSP	40	7	M	Z800120	515,65
1"1/2 BSP	40	7	M	Z800124	521,76
2" BSP	50	8	M	Z800132	1.000,98
1/4" BSP	6,3	1	H	Z800204	97,07
3/8" BSP	10	2	H	Z800206	109,23
1/2" BSP	12,5	3	H	Z800208	143,45
3/4" BSP	20	4	H	Z800212	212,95
1" BSP	25	5	H	Z800216	298,46
1"1/4 BSP	40	7	H	Z800220	752,26
1"1/2 BSP	40	7	H	Z800224	752,26
2" BSP	50	8	H	Z800232	1.565,22

Quick coupling 7241-A

Enchufes de punzón 7241-A

SVK nach 7241-A

Coupleurs rapides à clapet 7241-A



ROSCA THREAD	TAMAÑO ISO ISO SIZE	TAMAÑO BG BG SIZE	E. C.	Referencia Part n°	€
3/8" BSP	10	2	M	Z820106	46,91
1/2" BSP	12,5	3	M	Z820108	69,96
3/4" BSP	20	4	M	Z820112	94,64
1" BSP	25	5	M	Z820116	157,76
1"1/4 BSP	31,5	6	M	Z820120	376,16
1"1/2 BSP	40	7	M	Z820124	521,76
2" BSP	50	8	M	Z820132	1.000,98
3/8" BSP	10	2	H	Z820206	129,01
1/2" BSP	12,5	3	H	Z820208	136,97
3/4" BSP	20	4	H	Z820212	222,29
1" BSP	25	5	H	Z820216	282,12
1"1/4 BSP	31,5	6	H	Z820220	746,21
1"1/2 BSP	40	7	H	Z820224	940,34
2" BSP	50	8	H	Z820232	1.783,62

Quick screw couplings ISO 14541

Enchufes autoroscantes ISO 14541

SV-Schraubkupplungen ISO 14541

Coupleur rapide à visser filetage ISO 14541



ROSCA THREAD	TAMAÑO ISO ISO SIZE	TAMAÑO BG BG SIZE	E. C.	Referencia Part n°	€
1/4" BSP	6,3	1	M	Z800804	206,29
3/8" BSP	10	2	M	Z800806	125,62
1/2" BSP	12,5	3	M	Z800808	151,65
3/4" BSP	20	4	M	Z800812	250,59
1" BSP	25	5	M	Z800816	327,63
1"1/4 BSP	40	7	M	Z800820	1.231,54
1"1/2 BSP	40	7	M	Z800824	1.231,54
1/4" BSP	6,3	1	H	Z800904	151,10
3/8" BSP	10	2	H	Z800906	109,23
1/2" BSP	12,5	3	H	Z800908	133,49
3/4" BSP	20	4	H	Z800912	212,35
1" BSP	25	5	H	Z800916	283,94
1"1/4 BSP	40	7	H	Z800920	922,13
1"1/2 BSP	40	7	H	Z800924	922,13

Quick coupling free flow 7241-B

Enchufes paso total 7241-B

SVK 7241-B voller Durchgang

Coupleurs rapides passage total 7241-B



ROSCA THREAD	TAMAÑO ISO ISO SIZE	TAMAÑO BG BG SIZE	E. C.	Referencia Part n°	€
1/8" BSP	5	0	M	Z830102	30,55
1/4" BSP	6,3	1	M	Z830104	31,47
3/8" BSP	10	2	M	Z830106	34,22
1/2" BSP	12,5	3	M	Z830108	40,52
3/4" BSP	20	4	M	Z830112	66,40
1" BSP	25	5	M	Z830116	99,55
1"1/4 BSP	40	7	M	Z830120	222,01
1"1/2 BSP	40	7	M	Z830124	222,01
2" BSP	50	8	M	Z830132	837,23
1/8" BSP	5	0	H	Z830202	90,84
1/4" BSP	6,3	1	H	Z830204	85,99
3/8" BSP	10	2	H	Z830206	103,68
1/2" BSP	12,5	3	H	Z830208	119,85
3/4" BSP	20	4	H	Z830212	169,83
1" BSP	25	5	H	Z830216	282,11
1"1/4 BSP	40	7	H	Z830220	433,67
1"1/2 BSP	40	7	H	Z830224	433,67
2" BSP	50	8	H	Z830232	1.395,36

Quick couplings AISI 316

Enchufes rápidos AISI 316

SVK AISI 316

Coupleurs rapides AISI 316

Flat face quick coupling ISO16028

Enchufes de válvula plana ISO16028

Flachdichtende Kupplungen

Coupleurs à clapet face plane ISO16028



ROSCA THREAD	TAMAÑO ISO ISO SIZE	TAMAÑO BG BG SIZE	E. C.	Referencia Part n°	€
1/4" BSP	6,3	1	M	Z900104	160,14
3/8" BSP	10	2	M	Z900106	197,68
1/2" BSP	12,5	3	M	Z900108	226,85
3/4" BSP	16	4A	M	Z900112	310,44
1" BSP	19	4	M	Z900116	335,07
1"1/4 BSP	25	5	M	Z900120	323,94
1"1/2 BSP	38	7	M	Z900124	650,54
2" BSP	51	8	M	Z900132	1.452,08
1/4" BSP	6,3	1	H	Z900204	265,58
3/8" BSP	10	2	H	Z900206	315,47
1/2" BSP	12,5	3	H	Z900208	370,33
3/4" BSP	16	4A	H	Z900212	461,35
1" BSP	19	4	H	Z900216	545,83
1"1/4 BSP	25	5	H	Z900220	796,56
1"1/2 BSP	38	7	H	Z900224	1.577,33
2" BSP	51	8	H	Z900232	2.497,58

Flat face screw couplings, connection u/pressure

Válvula plana autoroscante acoplamiento en presión

SV-Schraubkupplung flach

Coupleurs face plane à visser, connexion sous pression



ROSCA THREAD	TAMAÑO ISO ISO SIZE	TAMAÑO BG BG SIZE	Referencia Part n°	€
3/8" BSP	M30x2	10	2	Z905106 257,25
1/2" BSP	M36x2	12,5	3	Z905108 316,68
3/4" BSP	M36x2	16	4A	Z905112 314,26
1" BSP	M43x3	19	4	Z905116 467,12
1"1/4 BSP	M48x3	25	5	Z905120 715,89
1"1/2 BSP	M80x4	40	7	Z905124 1.334,66
3/8" BSP	M30X2	10	2	Z905206 218,40
1/2" BSP	M36X2	12,5	3	Z905208 310,62
3/4" BSP	M36X2	16	4A	Z905212 286,36
1" BSP	M43X3	19	4	Z905216 424,69
1"1/4 BSP	M48X3	25	5	Z905220 612,72
1"1/2 BSP	M80X4	40	7	Z905224 2.014,13

Quick coupling ball type 700 bar connection u/pressure

Enchufes de bola 700 bar acoplamiento en presión

SVK, Kugeltyp, Hochdruck 700bar

Coupleurs rapides à bille 700 bar connexion sous pression



ROSCA THREAD	TAMAÑO ISO ISO SIZE	TAMAÑO BG BG SIZE	E. C.	Referencia Part n°	€
3/8" NPT	10	2	M	Z711106	102,24
3/8" NPT	10	2	H	Z711206	140,76

Quick couplings AISI 316

Enchufes rápidos AISI 316

SVK AISI 316

Coupleurs rapides AISI 316

TrΔle®

CRIMPING FITTINGS
FOR HOSES

Quick couplings 7241-A TrΔle®

Enchufes TrΔle® 7241-A

SVK 7241-A TrΔle®

Coupleurs 7241-A TrΔle®



ROSCA THREAD	TAMAÑO ISO ISO SIZE	TAMAÑO BG BG SIZE	E. C.	Referencia Part n°	€
1/4" BSP	6,3	1	M	ZB820104	16,58
3/8" BSP	10	2	M	ZB820106	25,44
1/2" BSP	12,5	3	M	ZB820108	43,32
3/4" BSP	20	4	M	ZB820112	77,89
1" BSP	25	5	M	ZB820116	108,19
1/4" BSP	6,3	1	H	ZB820204	40,30
3/8" BSP	10	2	H	ZB820206	60,89
1/2" BSP	12,5	3	H	ZB820208	101,77
3/4" BSP	20	4	H	ZB820212	182,32
1" BSP	25	5	H	ZB820216	254,37

Quick couplings 7241-A NPT TrΔle®

Enchufes NPT TrΔle® 7241-A

SVK 7241-A NPT TrΔle®

Coupleurs 7241-A NPT TrΔle®



ROSCA THREAD	TAMAÑO ISO ISO SIZE	TAMAÑO BG BG SIZE	E. C.	Referencia Part n°	€
1/4" NPT	6,3	1	M	ZB801104	16,32
3/8" NPT	10	2	M	ZB801106	26,08
1/2" NPT	12,5	3	M	ZB801108	43,66
3/4" NPT	20	4	M	ZB801112	79,36
1" NPT	25	5	M	ZB801116	110,23
1/4" NPT	6,3	1	H	ZB801204	39,65
3/8" NPT	10	2	H	ZB801206	62,42
1/2" NPT	12,5	3	H	ZB801208	103,69
3/4" NPT	20	4	H	ZB801212	185,76
1" NPT	25	5	H	ZB801216	260,28

PIPE
FITTINGS

PIPE
FITTINGS II

ADAPTORS

Quick couplings 7241-B TrΔle®

Enchufes TrΔle® 7241-B

SVK I7241-B TrΔle®

Coupleurs TrΔle® 7241-B



ROSCA THREAD	TAMAÑO ISO ISO SIZE	TAMAÑO BG BG SIZE	E. C.	Referencia Part n°	€
1/8" BSP	5	0	M	ZB800102	12,36
1/4" BSP	6,3	1	M	ZB800104	16,46
3/8" BSP	10	2	M	ZB800106	26,32
1/2" BSP	12,5	3	M	ZB800108	43,88
3/4" BSP	20	4	M	ZB800112	79,81
1" BSP	25	5	M	ZB800116	110,80
1/8" BSP	5	0	H	ZB800202	27,65
1/4" BSP	6,3	1	H	ZB800204	39,88
3/8" BSP	10	2	H	ZB800206	65,25
1/2" BSP	12,5	3	H	ZB800208	104,22
3/4" BSP	20	4	H	ZB800212	186,77
1" BSP	25	5	H	ZB800216	260,55

Quick couplings 7241-B NPT TrΔle®

Enchufes NPT TrΔle® 7241-B

SVK 7241-B NPT TrΔle®

Coupleurs 7241-B NPT TrΔle®



ROSCA THREAD	TAMAÑO ISO ISO SIZE	TAMAÑO BG BG SIZE	E. C.	Referencia Part n°	€
1/4" NPT	6,3	1	M	ZB811104	16,52
3/8" NPT	10	2	M	ZB811106	26,11
1/2" NPT	12,5	3	M	ZB811108	43,95
3/4" NPT	20	4	M	ZB811112	79,71
1" NPT	25	5	M	ZB811116	112,84
1/4" NPT	6,3	1	H	ZB811204	39,85
3/8" NPT	10	2	H	ZB811206	62,30
1/2" NPT	12,5	3	H	ZB811208	104,09
3/4" NPT	20	4	H	ZB811212	186,42
1" NPT	25	5	H	ZB811216	260,10

WELDING
FITTINGS

INDUSTRIAL
FITTINGS

Quick couplings free flow TrΔle® 7241-B

Enchufes Paso Total TrΔle® 7241-B

SVK TrΔle® voller Durchgang 7241-B

Coupleurs passage total TrΔle® 7241-B



ROSCA THREAD	TAMAÑO ISO ISO SIZE	TAMAÑO BG BG SIZE	E. C.	Referencia Part n°	€
1/4" BSP	6,3	1	M	ZB830104	25,09
3/8" BSP	10	2	M	ZB830106	34,34
1/2" BSP	12,5	3	M	ZB830108	47,71
3/4" BSP	20	4	M	ZB830112	70,93
1" BSP	25	5	M	ZB830116	110,34
1/4" BSP	6,3	1	H	ZB830204	68,43
3/8" BSP	10	2	H	ZB830206	80,87
1/2" BSP	12,5	3	H	ZB830208	96,42
3/4" BSP	20	4	H	ZB830212	155,13
1" BSP	25	5	H	ZB830216	354,86

Flat face quick coupling ISO16028 TrΔle®

Enchufes de válvula plana ISO16028 TrΔle®

SVK flach ISO16028 TrΔle®

Coupleurs à clapet face plane ISO16028 TrΔle®



ROSCA THREAD	TAMAÑO ISO ISO SIZE	TAMAÑO BG BG SIZE	E. C.	Referencia Part n°	€
1/4" BSP	6	1	M	ZB900104	69,22
3/8" BSP	10	2	M	ZB900106	91,98
1/2" BSP	12	3	M	ZB900108	126,90
3/4" BSP	16	4A	M	ZB900112	148,41
1" BSP	19	4	M	ZB900116	220,25
1/4" BSP	6	1	H	ZB900204	160,57
3/8" BSP	10	2	H	ZB900206	214,53
1/2" BSP	12	3	H	ZB900208	238,60
3/4" BSP	16	4A	H	ZB900212	262,72
1" BSP	19	4	H	ZB900216	482,44

ACCESSORIES

CONTROL
COMPONENTS

FLOW
MEASURING

TRAILE LOK

Ball valves AISI 316

Llaves de paso AISI 316

Kugelhähne AISI 316

Robinets AISI 316

2 Way ball-valves BSP female ISO 228

Llave 2 vías rosca hembra BSP

2-Wege-KH w BSP ISO 228

Robinet haute pression 2 voies boisseau sphérique femelle BSP



DN	ROSCA THREAD	Referencia Part n°	€
4	1/8" BSP	MKH G 1/8	254,47
6	1/4" BSP	MKH G 1/4	168,96
10	3/8" BSP	MKH G 3/8	211,62
13	1/2" BSP	MKH G 1/2	217,77
16	5/8" BSP	MKH G 5/8*	460,88
20	3/4" BSP	MKH G 3/4	520,34
25	1" BSP	MKH G 1	574,78
25	1" 1/4 BSP	MKH G 1 1/4 DN25	724,79
25	1" 1/2 BSP	MKH G 1 1/2 DN25	823,11

*Until end of stock / Hasta fin de existencias / Bis zum Ende des Lagerbestandes / Jusqu'à la fin du stock

2 Way ball-valves: tube connection serie L DIN 2353

Llave 2 vías tubo rígido serie ligera

2-Wege-KH Rohr L Leichte Serie

Robinet haute pression 2 voies boisseau sphérique pour tube rigide série légère



DN	TUBO PIPE	ROSCA THREAD	Referencia Part n°	€
4	6 L	M12X1,5	MKH 6 L	338,31
6	8 L	M14X1,5	MKH 8 L	299,05
8	10 L	M16X1,5	MKH 10 L	299,05
10	12 L	M18X1,5	MKH 12 L	274,65
13	15 L	M22X1,5	MKH 15 L	320,25
16	18 L	M26X1,5	MKH 18 L	317,56
20	22 L	M30X2	MKH 22 L	557,94
25	28 L	M36X2	MKH 28 L	710,70
25/32	35 L	M45X2	MKH 35 L	745,48
25/40	42 L	M52X2	MKH 42 L	1.001,36

2 Way ball-valves: tube connection serie S DIN 2353

Llave 2 vías tubo rígido serie pesada

2-Wege-KH Rohr S Schwere Serie

Robinet haute pression 2 voies boisseau sphérique pour tube rigide série lourde



DN	TUBO PIPE	ROSCA THREAD	Referencia Part n°	€
4	8 S	M16X1,5	MKH 8 S	299,05
6	10 S	M18X1,5	MKH 10 S	312,05
8	12 S	M20X1,5	MKH 12 S	262,99
10	14 S	M22X1,5	MKH 14 S	345,81
13	16 S	M24X1,5	MKH 16 S	282,91
13	20 S	M30X2	MKH 20 S DN13	414,40
16	20 S	M30X2	MKH 20 S	479,86
25	30 S	M42X2	MKH 30 S	598,74
20	25 S	M36X2	MKH 25 S	519,19
25/32	38 S	M52X2	MKH 38 S	682,58

Ball-valves BSP female

Llave 2 vías rosca hembra BSP paso total

2-Wege-KH w BSP voller Durchgang

Robinet haute pression 2 voies boisseau sphérique femelle



DN	ROSCA THREAD	Referencia Part n°	€
32	1" 1/4 BSP	MKH G 1 1/4 DN32	1.265,45
50	2" BSP	MKH G 2 DN50	2.172,51

Ball-valves: tube connection serie L DIN 2353 full bore

Llave 2 vías tubo rígido L paso total

2-Wege-KH Rohr DIN 2353 L voller Durchgang

Robinet haute pression 2 voies boisseau sphérique Métrique série légère passage total



DN	TUBO PIPE	ROSCA THREAD	Referencia Part n°	€
35	35 L	M45X2	MKH 35 L DN35	1.432,03

Ball-valves: tube connection serie S DIN 2353 full bore

Llave 2 vías tubo rígido S paso total

2-Wege-KH Rohr DIN 2353 S voller Durchgang

Robinet haute pression 2 voies boisseau sphérique Métrique série légère passage total



DN	TUBO PIPE	ROSCA THREAD	Referencia Part n°	€
32	38 S	M52x2	MKH 38 S DN32	1.408,78

3 Way ball-valve female BSP L flow

Llave 3 vías hembra - hembra - hembra BSP paso en L

3-Wege-KH w - w BSP - BSP Typ L

Robinet haute pression 3 voies boisseau sphérique femelle BSP passage en L



DN	ROSCA THREAD	Referencia Part n°	€
4	1/8" BSP	MK3A-G 1/8	551,28
6	1/4" BSP	MK3A-G 1/4	433,94
10	3/8" BSP	MK3A-G 3/8	611,10
13	1/2" BSP	MK3A-G 1/2	534,69
20	3/4" BSP	MK3A-G 3/4	1.089,68
25	1" BSP	MK3A-G 1	1.530,60
25	1" 1/4 BSP	MK3A-G 1 1/4	1.771,50
40	1" 1/2 BSP	MK3A-G 1 1/2	3.827,88

Ball valves AISI 316

Llaves de paso AISI 316

Kugelhähne AISI 316

Robinets AISI 316

Handles for ball-valves

Manetas

Handhebel für Kugelhähne

Leviers pour robinets

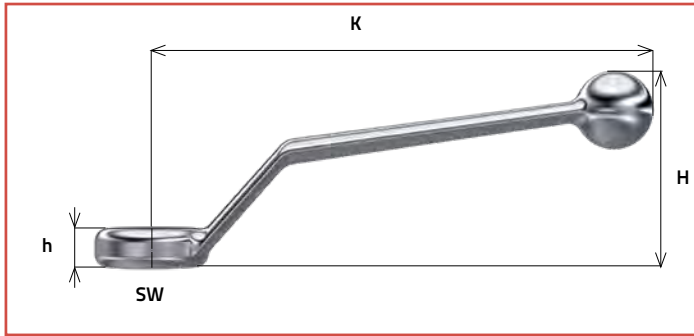

Handles for ball-valves 2

Manetas

Handhebel für Kugelhähne

Leviers pour robinets

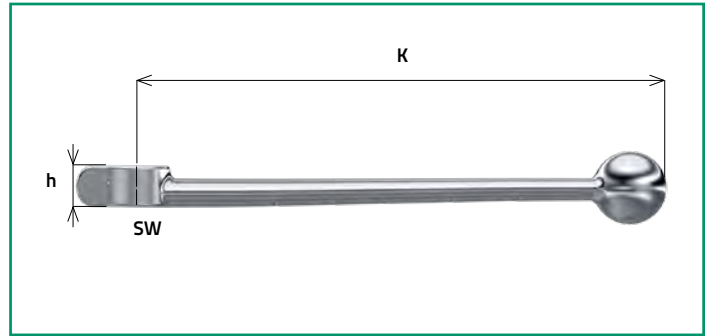

	SW	Zinc Zinc						Aluminio Aluminum			INOX/SS316L			Acero Steel		
Serie BSP 1/8 - 1/4 - 3/8 - 1/2 - 5/8	9	A60013155330* (1)			AR603722*						Z60013155330 *			C600063*		
Serie DIN 6 - 8 - 10 - 12 - 14 - 15 - 16		H	J	K	H	J	K	H	J	K	H	J	K	H	J	K
		45	8.7	155	-	10	155	45	8.7	155	47	9	155			
Serie BSP 5/8	12							L501741* (1)								
Serie DIN 18		H	J	K	H	J	K	H	J	K	H	J	K	H	J	K
		55	12	160												
Serie BSP 3/4 - 1 - 1 1/4	14	A60013155331* (1)						LR606745 *			Z60013155331*			C708618*		
Serie DIN 22 - 25 - 28 - 30 - 35 - 38		H	J	K	H	J	K	H	J	K	H	J	K	H	J	K
		-	13	200	-	12	200	-	13	200	64	12	171			
Serie BSP 1 1/4 - 1 1/2 - 2	17							LR801799* (1)			Z60013155332*					
Serie DIN 3 3-5 - 38 - 42		H	J	K	H	J	K	H	J	K	H	J	K	H	J	K
		-	16	320	-	15	90									

Handles for ball-valves are supplied with zinc or aluminum.

Las llaves se suministran con maneta de zinc o aluminio.

Griffe für Kugelhähne werden in Zink oder Aluminium geliefert

Leviers pour robinets sont fournies avec une poignée en zinc ou en aluminium.

(1) Handles are supplied for ball-valves / Maneta suministrada junto a la llave / Für Kugelhähne werden Griffe mitgeliefert / Leviers sont fournies pour robinets /

Ball valves AISI 316

Llaves de paso AISI 316

Kugelhähne AISI 316

Robinets AISI 316

TrΔle®**2 ways ball valve female BSP TrΔle®**

Llave 2 vías rosca hembra BSP TrΔle®

2-Wege-KH w BSP TrΔle®

Robinet haute pression 2 voies boisseau sphérique femelle BSP TrΔle®



DN	ROSCA THREAD	Referencia Part n°	€
4	1/8" BSP	ZGB2V 1/8	74,73
6	1/4" BSP	ZGB2V 1/4	117,26
10	3/8" BSP	ZGB2V 3/8	143,06
13	1/2" BSP	ZGB2V 1/2	158,81
20	3/4" BSP	ZGB2V 3/4	243,06
25	1" BSP	ZGB2V 1	336,27

2 ways ball valve female NPT TrΔle®

Llave 2 vías rosca hembra NPT TrΔle®

2-Wege-KH w NPT TrΔle®

Robinet haute pression 2 voies boisseau sphérique femelle NPT TrΔle®



DN	ROSCA THREAD	Referencia Part n°	€
6	1/4" NPT	ZGB2V 1/4 NPT	117,26
10	3/8" NPT	ZGB2V 3/8 NPT	143,06
12	1/2" NPT	ZGB2V 1/2 NPT	158,81
19	3/4" NPT	ZGB2V 3/4 NPT	243,06
25	1" NPT	ZGB2V 1 NPT	379,72

2 ways ball valve: tube connector light serie TrΔle®

Llave 2 vías tubo rígido serie ligera TrΔle®

2-Wege-KH Rohr L Leichte Serie TrΔle®

Robinet haute pression 2 voies boisseau sphérique sortie pour tube rigide Série légère TrΔle®



DN	TUBO PIPE	ROSCA THREAD	Referencia Part n°	€
6	8 L	M14X1,5	ZGB2V 8 L	125,62
8	10 L	M16X1.5	ZGB2V 10 L	145,99
10	12 L	M18X1.5	ZGB2V 12 L	145,99
13	15 L	M22X1.5	ZGB2V 15 L	181,68
16	18 L	M26X1.5	ZGB2V 18 L	181,68
20	22 L	M30X2	ZGB2V 22 L	307,87
25	28L	M36X2	ZGB2V 28 L	364,60

2 ways ball valve: tube connector heavy serie TrΔle®

Llave 2 vías tubo rígido serie pesada TrΔle®

2-Wege-KH Rohr S Schwere Serie TrΔle®

Robinet haute pression 2 voies boisseau sphérique sortie pour tube rigide Série lourde TrΔle®



DN	TUBO PIPE	ROSCA THREAD	Referencia Part n°	€
4	8 S	M16X1.5	ZGB2V 8 S	128,47
6	10 S	M18X1.5	ZGB2V 10 S	128,47
8	12 S	M20X1.5	ZGB2V 12 S	145,99
10	14 S	M22X1.5	ZGB2V 14 S	154,43
13	16 S	M24X1.5	ZGB2V 16 S	181,68
16	20 S	M30X2	ZGB2V 20 S	204,39
20	25 S	M36X2	ZGB2V 25 S	307,87

3 Way ball-valve female ISO 228

Llave 3 vías TrΔle® hembra - hembra - hembra BSP paso en L

3-Wege-Kugelhähne weiblich - weiblich BSP - BSP Durchgang L

Robinet haute pression 3 voies boisseau sphérique femelle



DN	R1	Referencia Part n°	€
6	1/4" BSP	ZGB3VH 1/4	106,83
10	3/8" BSP	ZGB3VH 3/8	160,24
13	1/2" BSP	ZGB3VH 1/2	201,78
20	3/4" BSP	ZGB3VH 3/4	346,10
25	1" BSP	ZGB3VH 1	511,87

Handles for ball-valves

Manetas para llaves de paso

Handhebel für Kugelhähne

Leviers pour robinets



TAMAÑO SIZE	Referencia Part n°	€
HEX9	Z60013155330	24,60
HEX14	Z60013155331	41,31
HEX17	Z60013155332	282,78

See dimension table in page 243 / Ver tabla de dimensiones en pág 243 / Abmessungen entspr. der Tabelle auf S. 243 / Voir table de dimensions à la page 243

Swivel fittings AISI 316 TrΔle®

Racores giratorios AISI 316 TrΔle®
Edelstahl-Drehverschraubungen AISI 316 TrΔle®
Raccords tournants AISI 316 TrΔle®

Straight swivel fittings TrΔle®

Racores giratorios rectos TrΔle®

Gerade Drehverschraubungen TrΔle®

Raccord tournant droit TrΔle®



ROSCA THREAD	Referencia Part n°	€
1/4" BSP	Z GGL 1/4	219,80
3/8" BSP	Z GGL 3/8	252,27
1/2" BSP	Z GGL 1/2	283,04
3/4" BSP	Z GGL 3/4	361,62
1" BSP	Z GGL 1	484,06
1" 1/4 BSP	Z GGL 1 1/4	671,15
1" 1/2 BSP	Z GGL 1 1/2	1.012,08
2" BSP	Z GGL 2	1.356,98

Elbow 90° swivel female TrΔle®

Racores giratorios 90° TrΔle®

W-Drehverschraubungen 90° TrΔle®

Raccord tournant coude 90° TrΔle®



ROSCA THREAD	Referencia Part n°	€
1/4" BSP	Z GG90 1/4	277,35
3/8" BSP	Z GG90 3/8	333,20
1/2" BSP	Z GG90 1/2	405,95
3/4" BSP	Z GG90 3/4	501,14
1" BSP	Z GG90 1	670,01
1" 1/4 BSP	Z GG90 1 1/4	1.044,86
1" 1/2 BSP	Z GG90 1 1/2	1.445,16
2" BSP	Z GG90 2	2.075,04

SWIVEL FITTINGS UNDER REQUEST
RACORES GIRATORIOS BAJO PEDIDO

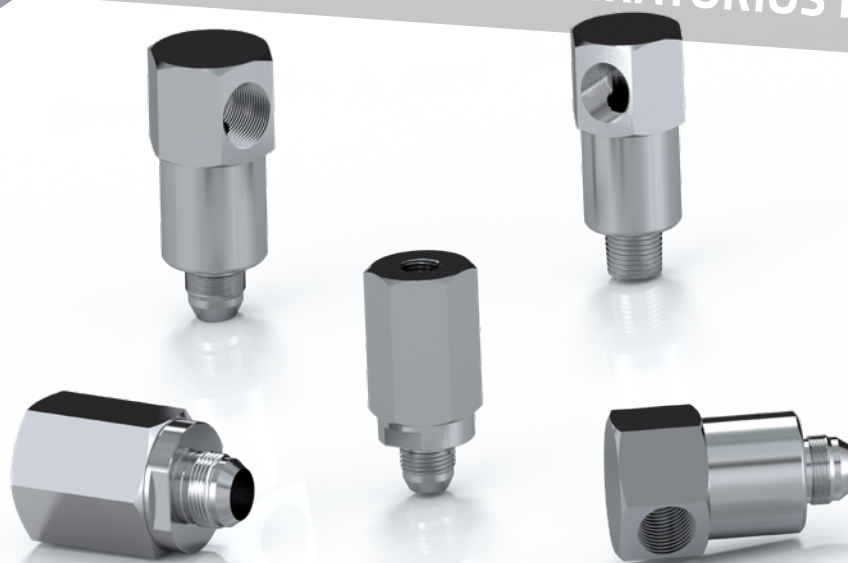

NPT

JIC

UNF

Hydraulic Components AISI 316 | 249

Componentes hidráulicos AISI 316
Hydraulische Komponenten AISI 316
Composants Hydrauliques AISI 316



08

CONTROL COMPONENTS

Elementos de control

Kontrollelemente

Éléments de contrôle

Hydraulic Components AISI 316

Componentes hidráulicos AISI 316
Hydraulische Komponenten AISI 316
Composants Hydrauliques AISI 316

Flow control valves ▪ Reguladores caudal ▪ Flusskontrollventil ▪ Régulateurs de débit

| 249



ZFT2251B



ZFT2253U



ZFT22512B



ZFT22572B

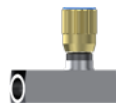

ZFT22575U

Check-valves ▪ Anti-retornos ▪ Rückschlagventile - RV ▪ Clapet antiretour

|



Z FPR

Check-valves TrΔle® ▪ Anti-retornos TrΔle® ▪ Rückschlagventile -RV TrΔle® ▪ Clapet antiretour TrΔle®

| 250



ZVT0

Relief valves ▪ Limitadoras ▪ Überdruckventile ▪ Limiteurs de pression

| 250



ZLIM

Hydraulic Components AISI 316

Componentes hidráulicos AISI 316
Hydraulische Komponenten AISI 316
Composants Hydrauliques AISI 316

Forged bidirectional flow control valve 350 Bar

Regulador caudal forjado bidireccional 350 Bar

Zweiwege-Ventile 350 Bar

Régulateur débit bidirectionnel forgé 350 Bar



ROSCA THREAD	CAUDAL MÁX. MAX. FLOW (l/min)	Referencia Part n°	€
1/4" BSP M17x1	12	ZFT2251B04	190,01
3/8" BSP M20x1	30	ZFT2251B06	235,04
1/2" BSP M25x1,5	45	ZFT2251B08	366,91
3/4" BSP M30x1,5	85	ZFT2251B12	494,00

Forged unidirectional flow control valve 350 Bar

Regulador caudal forjado unidireccional 350 Bar

Einweg-Steuerventile geschmiedet 350 Bar

Régulateur débit unidirectionnel forgé 350 Bar



ROSCA THREAD	CAUDAL MÁX. MAX. FLOW (l/min)	Referencia Part n°	€
1/4" BSP M17x1	12	ZFT2253U04	228,23
3/8" BSP M20x1	30	ZFT2253U06	277,68
1/2" BSP M25x1,5	45	ZFT2253U08	395,30
3/4" BSP M30x1,5	85	ZFT2253U12	530,71

Forged unidirectional flow control valve male/female 350 Bar

Regulador caudal forjado bidireccional macho/
hembra 350 Bar

Einweg-Steuerventil geschmiedet m- w 350 Bar

Régulateur débit bidirectionnel forgé mâle/femelle
350 Bar



ROSCA THREAD	CAUDAL MÁX. MAX. FLOW (l/min)	Referencia Part n°	€
1/8" BSP M15x1	10	ZFT22512B02	221,68
1/4" BSP M17x1	13	ZFT22512B04	206,39
3/8" BSP M20x1	30	ZFT22512B06	254,44
1/2" BSP M25x1,5	60	ZFT22512B08	377,83
3/4" BSP M30x1,5	80	ZFT22512B12	508,87

Bidirectional flow control valve 400 Bar

Regulador caudal bidireccional 400 Bar

Zweiweg- Steuerventil 400 Bar

Régulateur débit bidirectionnel 400 Bar



ROSCA THREAD	CAUDAL MÁX. MAX. FLOW (l/min)	Referencia Part n°	€
1/4" BSP M20x1	13	ZFT22572B04	279,55
3/8" BSP M25x1,5	38	ZFT22572B06	365,04
1/2" BSP M30x1,5	50	ZFT22572B08	532,90
3/4" BSP M40x1,5	80	ZFT22572B12	823,37
1" BSP M50x1,5	190	ZFT22572B16	1.658,75
1"1/4 BSP M50x1,5	195	ZFT22572B20	1.812,72
1" 1/2 BSP M55x2	200	ZFT22572B24	2.866,50
2" BSP M65x2	200	ZFT22572B32	3.741,19

Unidirectional flow control valve 400 Bar

Regulador caudal unidireccional 400 Bar

Einweg- Steuerventile 400 Bar

Régulateur débit unidirectionnel 400 Bar



ROSCA THREAD	CAUDAL MÁX. MAX. FLOW (l/min)	Referencia Part n°	€
1/8" BSP M17x1	6	ZFT22575U02	491,40
1/4" BSP M20x1	14	ZFT22575U04	412,88
3/8" BSP M25x1,5	20	ZFT22575U06	517,61
1/2" BSP M30x1,5	45	ZFT22575U08	698,88
3/4" BSP M40x1,5	80	ZFT22575U12	1.083,26
1" BSP M50x1,5	180	ZFT22575U16	1.865,14
1"1/4 BSP M50x1,5	200	ZFT22575U20	2.044,22
1" 1/2 BSP M55x2	200	ZFT22575U24	3.680,04
2" BSP M65x2	200	ZFT22575U32	4.876,87

Hydraulic Components AISI 316

Componentes hidráulicos AISI 316
Hydraulische Komponenten AISI 316
Composants Hydrauliques AISI 316

Check-valve line mounting BSP



Anti-retorno en línea BSP

Rückschlagventil in Linie BSP

Clapet antiretour simple en ligne BSP



ROSCA THREAD	TARAJE (bar) SETTING (bar)	Referencia Part n°	€
1/4" BSP	0,5	Z VSR 1/4	57,90
1/4" BSP	2,5	Z VSR 1/4-2.5	104,98
1/4" BSP	5	Z VSR 1/4-5	104,98
1/4" BSP	10	Z VSR 1/4-10	104,98
3/8" BSP	0,5	Z VSR 3/8	66,48
3/8" BSP	2,5	Z VSR 3/8-2.5	101,92
3/8" BSP	5	Z VSR 3/8-5	113,04
3/8" BSP	10	Z VSR 3/8-10	145,34
1/2" BSP	0,5	Z VSR 1/2	75,48
1/2" BSP	2,5	Z VSR 1/2-2.5	134,58
1/2" BSP	5	Z VSR 1/2-5	134,58
1/2" BSP	10	Z VSR 1/2-10	134,58
3/4" BSP	0,5	Z VSR 3/4	133,69
1" BSP	0,5	Z VSR 1	206,26
1" 1/4 BSP	0,5	Z VSR 1 1/4	365,65
1" 1/2 BSP	0,5	Z VSR 1 1/2	441,60

For other standard spring pressures, consult us. / Para otras presiones de tarado estándar, consultar. / Bitte kontaktieren Sie uns für andere Standard-Drucke. / Pour d'autres pressions ressort standard, consultez-nous.

Check-valve line mounting BSP TrΔle®

Anti-retornos en línea BSP TrΔle®

Rückschlagventil in Linie BSP TrΔle®

Clapet antiretour simple en ligne BSP TrΔle®

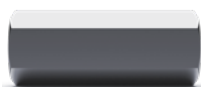

ROSCA THREAD	TARAJE (bar) SETTING (bar)	Referencia Part n°	€
1/4" BSP	0,5	ZVT001004	30,85
3/8" BSP	0,5	ZVT001006	38,34
1/2" BSP	0,5	ZVT001008	49,14
3/4" BSP	0,5	ZVT001012	74,74

For other standard spring pressures, consult us. / Para otras presiones de tarado estándar, consultar. / Bitte kontaktieren Sie uns für andere Standard-Drucke. / Pour d'autres pressions ressort standard, consultez-nous.

Relief valves in line BSP

Limitadoras en línea BSP

Überdruckventile in Linie BSP

Limiteurs de pression en ligne BSP



ROSCA THREAD	CAMPO REG. (bar) REG RATE (bar)	CAUDAL MÁX. MAX. FLOW (l/min)	Referencia Part n°	€
1/2" BSP	25-100	40	ZLIM1225100	525,00
1/2" BSP	60-210	40	ZLIM1260210	525,00
1/2" BSP	100-300	40	ZLIM12100300	525,00

*No sólo vendemos productos,
somos tu proveedor de
soluciones*

PROYECTOS

DICSA

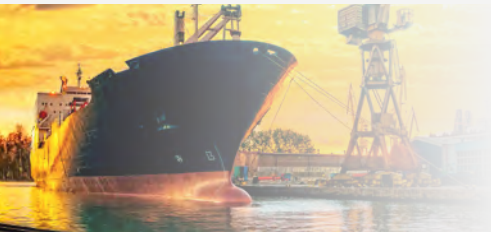

DICSA

PROJECTS

*We are involved in
key industrial sectors.*



www.dicsaes.com

Test couplings | 257

Racores de control
Kontrollarmaturen
Prises de pression

Micro-hose fittings | 258

Conexiones Micro-hose
Mikroschlauch-Armaturen
Embouts Capillaire

Pressure gauges AISI 316 with glycerin | 259

Instrumentos de medición
Manometer AISI 316L mit Glyzerin
Manomètre AISI 316 avec glycérine



09

FLOW MEASURING

Metrología

Messtechnik

Test du circuit hydraulique

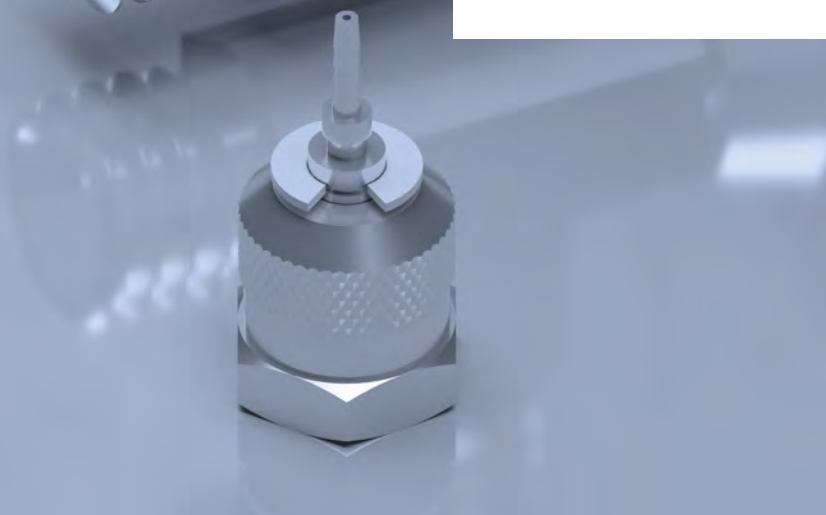

Test couplings

Racores de control
Kontrollarmaturen
Prises de pression

Checking fittings ▪ Racores de Control ▪ Kontrollarmaturen ▪ Prises de pression



Z MPR...C/J



Z MPR TLM



Z MPR DL/S



Z MPR...NPT



Z MPR M

Micro-hose fittings

Conexiones Micro-hose
Mikroschlauch-Armaturen
Embouts Capillaire

Micro-hose fittings ▪ Conexiones Micro-hose ▪ Mikroschlauch-Armaturen ▪ Embouts Capillaire

258



Z55501



Z55505



Z55506



Z55504



Z55507



Z55503



Z55509



Z5550795

CRIMPING FITTINGS
FOR HOSES

PIPE
FITTINGS

PIPE
FITTINGS II

ADAPTORS

WELDING
FITTINGS

INDUSTRIAL
FITTINGS

ACCESSORIES

CONTROL
COMPONENTS

FLOW
MEASURING

TRALE LOK

Pressure gauges AISI 316 with glycerin

Instrumentos de medición
Manometer AISI 316L mit Glycerin
Manomètre AISI 316 avec glycérine

Pressure gauge DN 63 with glycerin ▪ Manómetros inox glicerina DN 63 ▪ Edelstahl-Manometer mit Glycerin DN 63 ▪ Manomètre avec glycérine DN 63 | 259



ZMF163..V



ZMF163..DB

Pressure gauge DN 100 with glycerin ▪ Manómetros inox glicerina DN 100 ▪ Edelstahl-Manometer mit Glycerin DN 100 ▪ Manomètre avec glycérine DN 100 | 259



ZMF100..V



ZMF100..DB

Valves for manometers ▪ Protectores manómetros ▪ Manometer-Schutzventil ▪ Valves pour manomètres | 260



Z FPE



Z FPEA



ZFT2299

Test couplings

Racores de control
Kontrollarmaturen
Prises de pression

Check couplings with captive seal and metallic cap

Racores de control BSP con junta y capuchón metálico

Kupplungen mit Flachdichtung prüfen und Metallkappe

Prises de pression avec joint plat et capuchon métallique



ROSCA THREAD	Referencia Part n°	€
1/8" BSP	Z MPR 1/8 G	46,79
1/4" BSP	Z MPR 1/4 G	46,95
3/8" BSP	Z MPR 3/8 G	60,10
1/2" BSP	Z MPR 1/2 G	61,66

TLM Check couplings with metallic cap

Racores de control TLM con capuchón metálico

Kontrollarmaturen mit Ü-Mutter und Metallkappe

Prises de pression TLM avec capuchon métallique



TUBO PIPE	SERIE SERIES	ROSCA THREAD	Referencia Part n°	€
6	L	M12x1.5	Z MPR TLM 6L	123,08
8	L	M14x1.5	Z MPR TLM 8L	126,28
10	L	M16x1.5	Z MPR TLM 10L	104,96
12	L	M18x1.5	Z MPR TLM 12L	108,42
15	L	M22x1.5	Z MPR TLM 15L	113,49
6	S	M14x1.5	Z MPR TLM 6S	124,69
8	S	M16x1.5	Z MPR TLM 8S	108,42
10	S	M18x1.5	Z MPR TLM 10S	106,63
12	S	M20x1.5	Z MPR TLM 12S	110,09

Halfway check fitting for metal tube

Racor de control intermedio para tubo metálico

Kontroll-Zwischenverschraubung für Metallrohr

Raccord intermédiaire pour tube métallique



TUBO PIPE	SERIE SERIES	ROSCA THREAD	Referencia Part n°	€
6	L	M12X1,5	Z MPR DL 6	134,26
8	L	M14X1,5	Z MPR DL 8	140,66
10	L	M16X1,5	Z MPR DL 10	151,85
12	L	M18X1,5	Z MPR DL 12	137,48
15	L	M22X1,5	Z MPR DL 15	150,25
18	L	M26X1,5	Z MPR DL 18	176,96
22	L	M30X2	Z MPR DL 22	195,01
28	L	M36X2	Z MPR DL 28	295,71
35	L	M45X2	Z MPR DL 35	311,70
42	L	M52X2	Z MPR DL 42	284,54
6	S	M14X1,5	Z MPR DS 6	134,26
8	S	M16X1,5	Z MPR DS 8	147,07
10	S	M16X1,5	Z MPR DS 10	156,67
12	S	M18X1,5	Z MPR DS 12	145,48
14	S	M22X1,5	Z MPR DS 14	169,42
16	S	M24X1,5	Z MPR DS 16	156,67
20	S	M30X2	Z MPR DS 20	199,82
25	S	M36X2	Z MPR DS 25	247,76
30	S	M42X2	Z MPR DS 30	300,48
38	S	M52X2	Z MPR DS 38	300,48

NPT Check couplings with metallic cap

Racores de control NPT con capuchón metálico

NPT-Kupplungen prüfen mit Metallkappe

Prises de pression NPT avec capuchon métallique



ROSCA THREAD	Referencia Part n°	€
1/8" NPT	Z MPR 1/8 NPT	60,10
1/4" NPT	Z MPR 1/4 NPT	60,10
3/8" NPT	Z MPR 3/8 NPT	60,10

Metric Check couplings with captive seal and metallic cap

Racores de control Métrico con Junta y capuchón metal

Metrische Kupplungen mit Flachdichtung prüfen und Metallkappe

Prises de pression métrique avec joint plat et capuchon métallique



ROSCA THREAD	Referencia Part n°	€
M10X1.5	Z MPR M 10X1.5	58,48
M12X1.5	Z MPR M 12X1.5	59,34
M14X1.5	Z MPR M 14X1.5	56,98
M16X1.5	Z MPR M 16X1.5	57,90

Micro-hose fittings

Conexiones Micro-hose
Mikroschlauch-Armaturen
Embouts Capillaire

Ferrules AISI -303

Casquillos AISI-303

Pressfassungen AISI-303

Jupes AISI-303



DN	Referencia Part n°	€
2	Z555010100	2,86

Swivel female flat seat with o'ring for manometer Micro-hose

Hembra asiento plano con junta manómetro

Dichtkopf flachdichtend mit Dichtring für Manometer

Embout femelle tournante fond plat avec o'ring pour manomètre Minimess



DN	ROSCA THREAD	Referencia Part n°	€
2	1/4" BSP	Z555050404	17,42
2	1/2" BSP	Z555050808	29,50

Check Metric swivel female Micro-hose

Hembra giratoria de control

Kontroll-Dichtkopf mit Ü-Mutter

Embout femelle tournante de control Métrique Minimess



DN	ROSCA THREAD	Referencia Part n°	€
2	M16X2	Z555069523	23,06

Straight swivel female BSP 60° cone micro-hose

Hembra giratoria BSP 60°

Dichtkopf 60°

Embout femelle tournante gaz cyl BSP 60° Minimess



DN	ROSCA THREAD	Referencia Part n°	€
2	1/8" BSP	Z555040202	34,12
2	1/4" BSP	Z555040404	21,45
2	3/8" BSP	Z555040606	54,86

Metric standpipe Micro-hose

Espiga lisa Métrica

Metr. Stutzen glatt

Embout lisse Métrique Minimess



DN	TUBO PIPE	Referencia Part n°	€
2	6	Z555070600	11,26
2	8	Z555070800	11,28

Straight Micro-hose check male

Macho de control

Kontroll-Außengewinde

Embout mâle manomètre



DN	Referencia Part n°	€
2	Z555030325	12,34

Straight swivel female JIC 37° Micro-hose

Hembra giratoria recta JIC 37°

Dichtkopf mit Ü-Mutter gerade JIC 37°

Embout femelle tournante JIC 37° Minimess



DN	ROSCA THREAD	Referencia Part n°	€
2	7/16" 20h UNF	Z555090700	25,24

Check 24° Metric swivel female with o'ring

Hembra giratoria Métrica con Junta

Kontroll-Dichtkopf 24° metrisch mit O-Ring

Embout femelle tournante de control Métrique 24° avec o'ring



DN	TUBO PIPE	ROSCA THREAD	Referencia Part n°	€
2	6L	M12X1,5	Z555079510	12,60
2	6S	M14X1,5	Z555079511	28,22
2	8L	M14X1,5	Z555079512	29,63
2	8S	M16X1,5	Z555079523	31,14
2	10L	M16X1,5	Z555079525	34,12

Pressure gauges AISI 316 with glycerin

Instrumentos de medición
Manometer AISI 316L mit Glycerin
Manomètre AISI 316 avec glycérine

Pressure gauge DN 63 vertical connection

Manómetros DN 63 salida vertical

Manometer DN 63 Ausgang vertikal

Manomètre DN 63 sortie verticale



ROSCA THREAD	ESCALA (bar) SCALE (bar)	Referencia Part n°	€
1/4" BSP	0-2.5	ZMFI6304002.5V	*
1/4" BSP	0-4	ZMFI6304004V	30,41
1/4" BSP	0-6	ZMFI6304006V	30,41
1/4" BSP	0-10	ZMFI6304010V	30,41
1/4" BSP	0-16	ZMFI6304016V	30,41
1/4" BSP	0-25	ZMFI6304025V	30,41
1/4" BSP	0-40	ZMFI6304040V	30,41
1/4" BSP	0-60	ZMFI6304060V	30,41
1/4" BSP	0-100	ZMFI6304100V	30,41
1/4" BSP	0-160	ZMFI6304160V	30,41
1/4" BSP	0-250	ZMFI6304250V	30,41
1/4" BSP	0-400	ZMFI6304400V	30,41
1/4" BSP	0-600	ZMFI6304600V	30,41

Pressure gauge DN 63 rear connection

Manómetros DN 63 dorsal

Manometer DN 63 Ausgang hinten

Manomètre DN 63 sortie arrière



ROSCA THREAD	ESCALA (bar) SCALE (bar)	Referencia Part n°	€
1/4" BSP	0-2.5	ZMFI63042.5DB	*
1/4" BSP	0-10	ZMFI6304010DB	33,80
1/4" BSP	0-16	ZMFI6304016DB	33,80
1/4" BSP	0-25	ZMFI6304025DB	33,80
1/4" BSP	0-60	ZMFI6304060DB	33,80
1/4" BSP	0-160	ZMFI6304160DB	33,80
1/4" BSP	0-250	ZMFI6304250DB	33,80
1/4" BSP	0-400	ZMFI6304400DB	33,80

Pressure gauge DN 100 vertical connection

Manómetros DN 100 salida vertical

Manometer DN 100 Ausgang vertikal

Manomètre DN 100 sortie verticale



ROSCA THREAD	ESCALA (bar) SCALE (bar)	Referencia Part n°	€
1/2" BSP	0-6	ZMFI10008006V	51,72
1/2" BSP	0-10	ZMFI10008010V	51,72
1/2" BSP	0-16	ZMFI10008016V	51,72
1/2" BSP	0-25	ZMFI10008025V	51,72
1/2" BSP	0-40	ZMFI10008040V	51,72
1/2" BSP	0-60	ZMFI10008060V	51,72
1/2" BSP	0-100	ZMFI10008100V	51,72
1/2" BSP	0-160	ZMFI10008160V	51,72
1/2" BSP	0-250	ZMFI10008250V	51,72
1/2" BSP	0-400	ZMFI10008400V	51,72
1/2" BSP	0-600	ZMFI10008600V	51,72

Pressure gauge DN 100 rear connection

Manómetros DN 100 dorsal

Manometer DN 100 Ausgang hinten

Manomètre DN 100 sortie arrière



ROSCA THREAD	ESCALA (bar) SCALE (bar)	Referencia Part n°	€
1/4" BSP	0-160	ZMFI10004160DB	*
1/2" BSP	0-1	ZMFI10008001DB	55,67
1/2" BSP	0-4	ZMFI10008004DB	55,67
1/2" BSP	0-6	ZMFI10008006DB	55,67
1/2" BSP	0-10	ZMFI10008010DB	55,67
1/2" BSP	0-16	ZMFI10008016DB	55,67
1/2" BSP	0-25	ZMFI10008025DB	55,67
1/2" BSP	0-40	ZMFI10008040DB	55,67
1/2" BSP	0-60	ZMFI10008060DB	55,67
1/2" BSP	0-100	ZMFI10008100DB	55,67
1/2" BSP	0-160	ZMFI10008160DB	55,67
1/2" BSP	0-250	ZMFI10008250DB	55,67
1/2" BSP	0-400	ZMFI10008400DB	*



**MANÓMETROS CALIBRADOS
BAJO CONSULTA**

**CALIBRATED MANOMETER
ON REQUEST**

Pressure gauges AISI 316 with glycerin

Instrumentos de medición
Manometer AISI 316L mit Glyzerin
Manomètre AISI 316 avec glycérine

Pressure gauge protector (line mounting)

Protector manómetro recto

Manometer-Schutzventil in Linie

Isolateur de manomètre droit (en ligne)



ROSCA THREAD		Referencia Part n°	€
1/4" BSP	1/4" BSPT	Z FPE 1G 1/4	201,15

90° pressure gauge protector (line mounting)

Protector manómetro 90°

Manometer-Schutzventil 90°

Isolateur de manomètre coudé a 90° (en ligne)



ROSCA THREAD		Referencia Part n°	€
1/4" BSP	1/4" BSPT	Z FPEA 1G 1/4	201,15

Pressure gauge adaptor (in line) SF-FM

Adaptador para manómetro en línea TL-MF

Manometer- Adapter TL- MF

Adapteur pour manomètre (en ligne) TL-MF



ROSCA (M) THREAD (M)	ROSCA (H) THREAD (F)	Referencia Part n°	€
1/4" BSP	1/4" BSPT	ZFT229904	70,70
1/2" BSP	1/2" BSPT	ZFT229908	94,38

**CALIDAD para conseguir el
mejor RENDIMIENTO.**

DICSA
GROWING UP TOGETHER

**QUALITY guarantees the
BEST PERFORMANCE.**

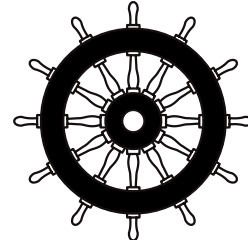

Emisión de certificados. Certificates Issuance.
Certificados de prueba. Test Certificates.
Validación de diseños. Design Validation Tests.
Controles de calidad. Quality Control.

Cortadora de precisión
Precision cutting Saw

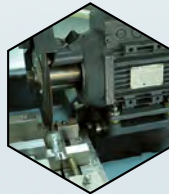

Máquina de medición 3D MMC
Machine Measuring by Coordinates (MMC)



Banco de prueba Bimal B1703 Flex
B1703 FLEX Dynamic Test Bench



Banco de prueba Bimal BI1001
Bimal BI1001 Test Bench

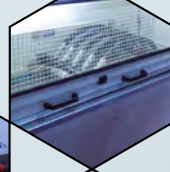

Análisis espectrográfico
Spectrographic Analyzer



Banco de pruebas BE 2500 II
BE 2500 II Test Bench

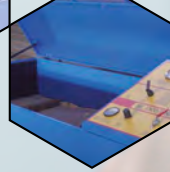

Cámara de niebla salina
Salt-spray chamber



Abrasímetro
Abrasion Tester



www.dicsaes.com

Twin Ferrule Fittings TrΔle® LOK | 267

Racor Doble Anillo TrΔle® LOK
Verschraubungen für Doppelklemmring TrΔle® LOK
Raccords double bague TrΔle® LOK



10

TWIN FERRULE FITTINGS TRΔLE® LOK

TrΔle® LOK Racor doble anillo

Verschraubungen für Doppelklemmring

Raccords double bague TrΔle® LOK

Twin Ferrule Fittings TrΔle® LOK

Racor Doble Anillo TrΔle® LOK
 Verschraubungen für Doppelklemmring TrΔle® LOK
 Raccords double bague TrΔle® LOK

Nuts and rings ▪ Tuercas y anillos ▪ Muttern und Schneidringe ▪ Écrous et bagues

| 267



ZKN



ZKAP



ZKAF

Straight couplings ▪ Uniones tubo-tubo ▪ Gerade Verschraubungen (G) ▪ Raccords union double

| 268



ZKI



ZKL



ZKI



ZKT



ZKC

Straight male stud couplings ▪ Uniones rectas tubo-rosca macho ▪ Gerade Einschraubverschr. - EVGE ▪ Raccords union simple mâle

| 270



ZKIMP



ZKIM

Male stud elbows ▪ Codos tubo-rosca ▪ W-Einschraubverschraubungen - WE ▪ Raccords coude mâle gaz

| 271



ZKLMP



ZKLM

Male stud branch ▪ TES rosca central ▪ T-Einschraubungen - TE ▪ Raccords Té mâle central

| 272



ZKTMP

Male stud barrel ▪ TES rosca lateral ▪ T-einschraubungen ▪ Raccords Té mâle latéral

| 272



ZKTLMP

Bulkhead ▪ Pasatabiques ▪ Schott ▪ Raccords passe cloison

| 272



ZKIB



ZKIBP

Straight female coupling ▪ Racor recto hembra ▪ Gerade Kupplung ▪ Raccords droits femelle

| 273



ZKIHP



ZKIH

Plugs ▪ Tapones ▪ Stopfen ▪ Raccords bouchon métrique

| 274



ZKOH



ZKOM

Twin Ferrule Fittings TrΔle® LOK

Racor Doble Anillo TrΔle® LOK
Verschraubungen für Doppelklemmring TrΔle® LOK
Raccords double bague TrΔle® LOK

Pipe connector ▪ Conectores para tubo ▪ Rohrverbinder ▪ Connecteur de tuyau

| 274



ZKIA

ZKIAMP

ZKIAHP

TRALE® LOK SERIES

INFORMACIÓN DE CODIFICACIÓN / CODIFICATION INFORMATION

1 EJEMPLO- EXAMPLE

ZKTK

ZK: DICSA TRALE® LOK SERIES

T: FIGURA (RACOR EN TE)/
FIGURE (TE UNION)

02: Ø Tubo (02 = 1/8")
Ø Tube (02 = 1/8")

2 EJEMPLO- EXAMPLE

ZKIMP0202

ZK: DICSA TRALE® LOK SERIES

IM: RACOR RECTO ROSCA TUBO/
STRAIGHT MALE STUD

P02: MACHO 1/8" NPT
MALE 1/8" NPT

02: Ø Tubo (02 = 1/8")
Ø Tube (02 = 1/8")

REF / CODE	DESCRIPCION / DESCRIPTION
ZKN	Tuercas / Nuts
ZKAP	Anillo trasero / Back Ferrule
ZKAF	Anillo frontal / Front Ferrule
ZKI	Unión recta / Straight Union
ZKL	Unión en codo / Elbow Union
ZKT	Unión en T / Tee Union
ZKC	Unión en cruz / Cross Union
ZKIM	Unión recta tubo-rosca / Straight male stud
ZKLMP	Codo tubo - rosca / Male stud elbow
ZKTMP	T tubo - rosca / Male stud T
ZKTLM	L tubo - rosca / Male stud L
ZKIB	Pasatabiques recto / Straight bulkhead
ZKIBP	Pasatabiques tubo-rosca / Male stud bulkhead
ZKIHP	Unión tubo-rosca hembra / Straight female stud
ZKOH	Tapón hembra / Cap
ZKOM	Tapón macho / Plug
ZKIA	Reductor tubo / Pipe Reducer
ZKIAH	Adap. hembra / Female adapter
ZKIMP	Adap macho / Male adapter

DESIGNACIÓN DE TUBO EXTERIOR/ TUBE O.D. DESIGNATOR

TUBO EN PULGADAS / FRACTIONAL TUBE								TUBO MÉTRICO / METRIC TUBE										
1/8"	1/4"	5/16"	3/8"	1/2"	5/8"	3/4"	1"	6	8	10	12	14	15	16	18	20	22	25
02	04	05	06	08	10	12	16	06M	08M	10M	12M	14M	15M	16M	18M	20M	22M	25M



Twin Ferrule Fittings TrΔle® LOK

Racor Doble Anillo TrΔle® LOK
 Verschraubungen für Doppelklemmring TrΔle® LOK
 Raccords double bague TrΔle® LOK

Nut for twin-ferrule

Tuercas para doble anillo

Mutter für Doppelklemmring

Écrou double bagues



TUBO PIPE	Referencia Part n°	€
1/8"	ZKN02	6,39
1/4"	ZKN04	6,66
5/16"	ZKN05	*
3/8"	ZKN06	7,97
1/2"	ZKN08	10,48
5/8"	ZKN10	26,81
3/4"	ZKN12	25,63
1"	ZKN16	45,81
6	ZKN06M	6,83
8	ZKN08M	7,57
10	ZKN10M	9,05
12	ZKN12M	10,35
14	ZKN14M	*
15	ZKN15M	21,73
16	ZKN16M	32,16
18	ZKN18M	25,50
20	ZKN20M	36,91
22	ZKN22M	37,67
25	ZKN25M	56,73

Back Ferrule

Anillo posterior

Hinterer Klemmring

Bague arrière



TUBO PIPE	Referencia Part n°	€
1/8"	ZKAP02	2,62
1/4"	ZKAP04	2,73
5/16"	ZKAP05	10,70
3/8"	ZKAP06	3,22
1/2"	ZKAP08	5,13
5/8"	ZKAP10	19,06
3/4"	ZKAP12	11,79
1"	ZKAP16	20,58
6	ZKAP06M	2,79
8	ZKAP08M	3,13
10	ZKAP10M	3,55
12	ZKAP12M	5,05
14	ZKAP14M	*
15	ZKAP15M	10,26
16	ZKAP16M	21,46
18	ZKAP18M	11,36
20	ZKAP20M	20,91
22	ZKAP22M	24,35
25	ZKAP25M	33,14

Front Ferrule

Anillo frontal

Vorderer Klemmring

Bague avant



TUBO PIPE	Referencia Part n°	€
1/8"	ZKAF02	2,40
1/4"	ZKAF04	2,40
5/16"	ZKAF05	8,95
3/8"	ZKAF06	2,57
1/2"	ZKAF08	4,15
5/8"	ZKAF10	16,65
3/4"	ZKAF12	8,46
1"	ZKAF16	13,05
6	ZKAF06M	2,45
8	ZKAF08M	2,64
10	ZKAF10M	2,78
12	ZKAF12M	4,06
14	ZKAF14M	*
15	ZKAF15M	8,46
16	ZKAF16M	18,78
18	ZKAF18M	9,77
20	ZKAF20M	17,69
22	ZKAF22M	19,76
25	ZKAF25M	24,90

Twin Ferrule Fittings TrΔle® LOK

Racor Doble Anillo TrΔle® LOK
Verschraubungen für Doppelklemmring TrΔle® LOK
Raccords double bague TrΔle® LOK

Double Straight coupling

Racor unión recta tubo - tubo

Gerade Verschraubungen (G)

Raccord union double



Straight reducing coupling

Racor unión recta en reducción tubo - tubo

Gerade Reduzierschraubungen (GR)

Raccord union double en réduction



TUBO PIPE	Referencia Part n°	€
1/8"	ZKI02	29,59
1/4"	ZKI04	33,17
5/16"	ZKI05	69,51
3/8"	ZKI06	35,76
1/2"	ZKI08	49,03
5/8"	ZKI10	*
3/4"	ZKI12	117,01
1"	ZKI16	203,00
6	ZKI06M	31,47
8	ZKI08M	33,37
10	ZKI10M	37,53
12	ZKI12M	49,42
14	ZKI14M	101,28
15	ZKI15M	134,04
16	ZKI16M	162,05
18	ZKI18M	87,31
20	ZKI20M	126,29
22	ZKI22M	200,55
25	ZKI25M	202,78

TUBO PIPE	TUBO PIPE	Referencia Part n°	€
1/4"	1/8"	ZKI0402	31,14
5/16"	1/4"	ZKI0504	*
3/8"	1/8"	ZKI0602	31,78
3/8"	1/4"	ZKI0604	32,32
1/2"	1/4"	ZKI0804	40,90
1/2"	3/8"	ZKI0806	42,59
5/8"	3/8"	ZKI1006	*
5/8"	1/2"	ZKI1008	*
3/4"	1/4"	ZKI1204	100,46
3/4"	3/8"	ZKI1206	103,25
3/4"	1/2"	ZKI1208	101,99
1"	1/2"	ZKI1608	163,58
1"	3/4"	ZKI1612	168,88
6	3	ZKI06M03M	*
8	6	ZKI08M06M	32,32
10	6	ZKI10M06M	32,92
10	8	ZKI10M08M	34,02
12	6	ZKI12M06M	40,90
12	8	ZKI12M08M	42,59
12	10	ZKI12M10M	43,68
16	12	ZKI16M12M	87,91
18	12	ZKI18M12M	64,05
25	18	ZKI25M18M	135,41
25	20	ZKI25M20M	144,36

Equal elbow coupling

Racor unión en codo tubo - tubo

Winkel-Verschraubungen (W)

Raccord coude égal



Equal Tee

Racor unión en T tubo - tubo

T-Verschraubungen (T)

Raccord Té égal



TUBO PIPE	Referencia Part n°	€
1/8"	ZKLO2	35,13
1/4"	ZKLO4	36,05
5/16"	ZKLO5	*
3/8"	ZKLO6	42,40
1/2"	ZKLO8	56,69
5/8"	ZKL10	*
3/4"	ZKL12	103,07
1"	ZKL16	187,47
6	ZKL06M	38,29
8	ZKL08M	43,58
10	ZKL10M	45,26
12	ZKL12M	55,40
14	ZKL14M	*
15	ZKL15M	176,71
16	ZKL16M	151,71
18	ZKL18M	135,96
20	ZKL20M	181,67
22	ZKL22M	180,40
25	ZKL25M	187,00

TUBO PIPE	Referencia Part n°	€
1/8"	ZKTO2	51,98
1/4"	ZKTO4	53,24
5/16"	ZKTO5	*
3/8"	ZKTO6	62,68
1/2"	ZKTO8	82,45
5/8"	ZKT10	*
3/4"	ZKT12	217,36
1"	ZKT16	280,97
6	ZKT06M	53,13
8	ZKT08M	61,71
10	ZKT10M	65,31
12	ZKT12M	82,50
14	ZKT14M	*
15	ZKT15M	205,02
16	ZKT16M	268,03
18	ZKT18M	163,64
20	ZKT20M	260,28
22	ZKT22M	245,59
25	ZKT25M	280,32

Twin Ferrule Fittings TrΔle® LOK

Racor Doble Anillo TrΔle® LOK
 Verschraubungen für Doppelklemmring TrΔle® LOK
 Raccords double bague TrΔle® LOK

Equal cross

Racor unión en cruz tubo - tubo

Kreuz-Verschraubungen (K)

Raccord croix égale



TUBO PIPE	Referencia Part n°	€
1/8"	ZKC02	110,07
1/4"	ZKC04	83,65
5/16"	ZKC05	*
3/8"	ZKC06	126,45
1/2"	ZKC08	158,01
6	ZKC06M	95,71
8	ZKC08M	154,85
10	ZKC10M	*
12	ZKC12M	158,39

■ TrΔle® Lok SERIES

Conexión libre de fugas
 Apta para entornos agresivos

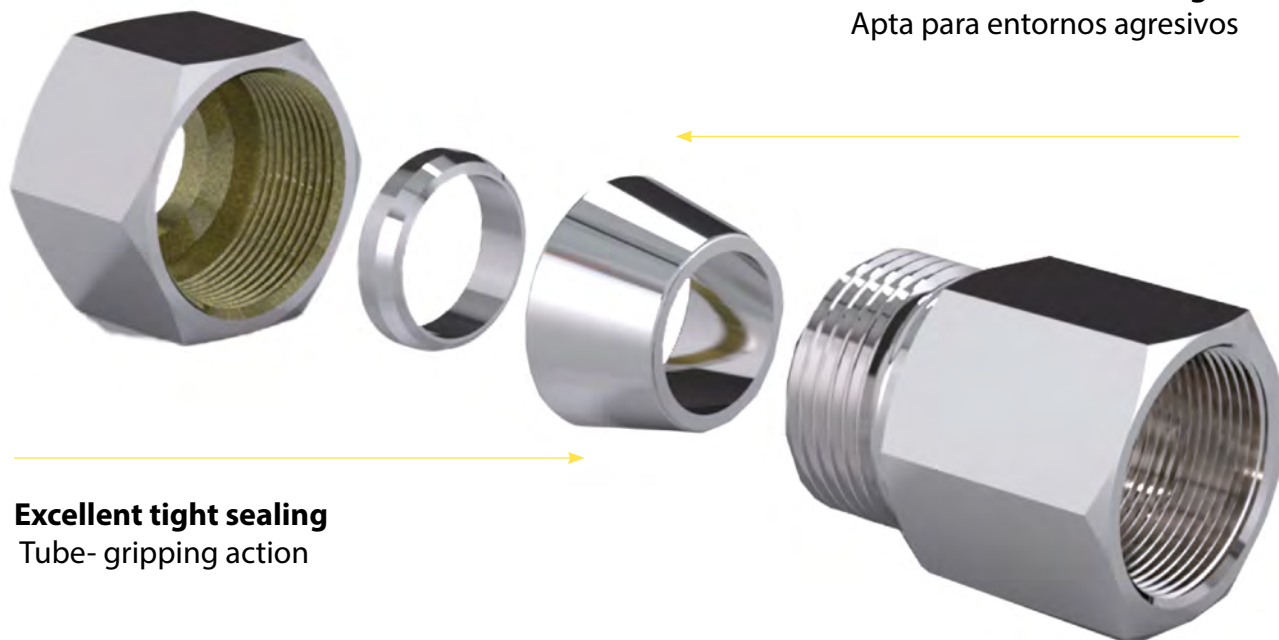

Excellent tight sealing
 Tube- gripping action

Twin Ferrule Fittings TrΔle® LOK

Racor Doble Anillo TrΔle® LOK
Verschraubungen für Doppelklemmring TrΔle® LOK
Raccords double bague TrΔle® LOK

Straight male stud coupling NPT

Racor recto rosca cónica NPT

Gerade Einschraubversch. NPT - GE -NPT

Raccord union simple mâle NPT

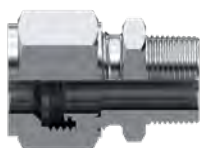

Straight male stud coupling BSPT

Racor recto rosca cónica BSPT

Gerade Einschraubversch. kegelig - GE-BSPT

Raccord union simple mâle conique BSPT



TUBO PIPE	ROSCA THREAD	Referencia Part n°	€
1/16"	1/8"	ZKIMP0102	*
1/8"	1/16"	ZKIMP0201	24,57
1/8"	1/8"	ZKIMP0202	17,53
1/8"	1/4"	ZKIMP0204	18,13
1/8"	3/8"	ZKIMP0206	19,49
1/8"	1/2"	ZKIMP0208	23,53
1/4"	1/8"	ZKIMP0402	18,07
1/4"	1/4"	ZKIMP0404	18,68
1/4"	3/8"	ZKIMP0406	20,36
1/4"	1/2"	ZKIMP0408	23,97
3/8"	1/8"	ZKIMP0602	20,53
3/8"	1/4"	ZKIMP0604	21,78
3/8"	3/8"	ZKIMP0606	22,23
3/8"	1/2"	ZKIMP0608	24,94
3/8"	3/4"	ZKIMP0612	34,07
3/8"	1"	ZKIMP0616	84,96
1/2"	1/8"	ZKIMP0802	30,36
1/2"	1/4"	ZKIMP0804	30,36
1/2"	3/8"	ZKIMP0806	30,36
1/2"	1/2"	ZKIMP0808	31,98
1/2"	3/4"	ZKIMP0812	45,21
3/4"	3/8"	ZKIMP1206	59,19
3/4"	1/2"	ZKIMP1208	60,72
3/4"	3/4"	ZKIMP1212	69,45
3/4"	1/4"	ZKIMP1216	76,28
1"	1/2"	ZKIMP1608	100,25
1"	3/4"	ZKIMP1612	102,92
1"	1"	ZKIMP1616	106,89
6	1/8"	ZKIMP06M02	18,24
6	1/4"	ZKIMP06M04	18,84
6	3/8"	ZKIMP06M06	20,04
6	1/2"	ZKIMP06M08	23,75
8	1/8"	ZKIMP08M02	19,49
8	1/4"	ZKIMP08M04	20,78
8	3/8"	ZKIMP08M06	20,91
8	1/2"	ZKIMP08M08	26,22
10	1/8"	ZKIMP10M02	22,88
10	1/4"	ZKIMP10M04	23,37
10	3/8"	ZKIMP10M06	23,37
10	1/2"	ZKIMP10M08	27,79
10	3/4"	ZKIMP10M12	46,08
12	1/4"	ZKIMP12M04	30,79
12	3/8"	ZKIMP12M06	30,55
12	1/2"	ZKIMP12M08	32,74
14	3/8"	ZKIMP14M06	85,89
14	1/2"	ZKIMP14M08	*
15	1/2"	ZKIMP15M08	61,32
16	1/4"	ZKIMP16M04	*
16	3/8"	ZKIMP16M06	85,89
16	1/2"	ZKIMP16M08	87,85
16	3/4"	ZKIMP16M12	*
18	1/2"	ZKIMP18M08	64,78
18	3/4"	ZKIMP18M12	79,08
22	3/4"	ZKIMP22M12	*
22	1"	ZKIMP22M16	*
25	1/2"	ZKIMP25M08	99,48
25	3/4"	ZKIMP25M12	102,76
25	1"	ZKIMP25M16	105,98

TUBO PIPE	ROSCA THREAD	Referencia Part n°	€
1/8"	1/8"	ZKIM0202	17,53
1/8"	1/4"	ZKIM0204	18,13
1/4"	1/8"	ZKIM0402	17,91
1/4"	1/4"	ZKIM0404	19,06
1/4"	3/8"	ZKIM0406	19,87
1/4"	1/2"	ZKIM0408	23,97
3/8"	1/8"	ZKIM0602	20,53
3/8"	1/4"	ZKIM0604	22,55
3/8"	3/8"	ZKIM0606	23,42
3/8"	1/2"	ZKIM0608	24,79
3/8"	3/4"	ZKIM0612	39,80
1/2"	1/4"	ZKIM0804	30,36
5/8"	1/2"	NEW ZKIM1008	110,00
1/2"	3/8"	ZKIM0806	30,36
1/2"	1/2"	ZKIM0808	31,94
1/2"	3/4"	ZKIM0812	46,41
3/4"	3/4"	ZKIM1212	69,45
3/4"	1"	ZKIM1216	76,28
1"	3/4"	ZKIM1612	102,92
6	1/8"	ZKIM06M02	18,24
6	1/4"	ZKIM06M04	18,51
6	3/8"	ZKIM06M06	20,04
6	1/2"	ZKIM06M08	23,75
8	1/8"	ZKIM08M02	19,49
8	1/4"	ZKIM08M04	19,82
8	3/8"	ZKIM08M06	20,91
8	1/2"	ZKIM08M08	25,66
10	1/8"	ZKIM10M02	22,88
10	1/4"	ZKIM10M04	23,37
10	3/8"	ZKIM10M06	23,91
10	1/2"	ZKIM10M08	26,89
12	1/4"	NEW ZKIM12M04	30,04
12	3/8"	ZKIM12M06	30,41
12	1/2"	ZKIM12M08	32,28
16	1/4"	ZKIM16M04	*
16	3/8"	ZKIM16M06	*
16	1/2"	ZKIM16M08	104,23
16	3/4"	ZKIM16M12	*
18	1/2"	ZKIM18M08	62,63
18	3/4"	ZKIM18M12	67,16
22	3/4"	ZKIM22M12	133,01
22	1"	ZKIM22M16	*
25	3/4"	ZKIM25M12	102,76
25	1"	ZKIM25M16	105,98
25	1/2"	ZKIM25M08	99,48

Twin Ferrule Fittings TrΔle® LOK

Racor Doble Anillo TrΔle® LOK
 Verschraubungen für Doppelklemmring TrΔle® LOK
 Raccords double bague TrΔle® LOK

Male stud elbow NPT

Racor en codo rosca cónica NPT

W-Einschraubverschr. NPT - WE-NPT kon

Raccord union coude mâle NPT



TUBO PIPE	ROSCA THREAD	Referencia Part n°	€
1/8"	1/8"	ZKLMP0202	25,53
1/8"	1/4"	ZKLMP0204	26,11
1/8"	3/8"	ZKLMP0206	28,85
1/4"	1/8"	ZKLMP0402	25,90
1/4"	1/4"	ZKLMP0404	27,74
1/4"	3/8"	ZKLMP0406	28,85
1/4"	1/2"	ZKLMP0408	35,82
3/8"	1/8"	ZKLMP0602	30,38
3/8"	1/4"	ZKLMP0604	30,38
3/8"	3/8"	ZKLMP0606	30,38
3/8"	1/2"	ZKLMP0608	38,49
3/8"	3/4"	ZKLMP0612	60,08
1/2"	1/4"	ZKLMP0804	39,83
1/2"	3/8"	ZKLMP0806	39,83
1/2"	1/2"	ZKLMP0808	42,46
3/4"	1/2"	ZKLMP1208	78,39
3/4"	3/4"	ZKLMP1212	81,14
1"	3/4"	ZKLMP1612	133,51
1"	1"	ZKLMP1616	133,51
16	1/4"	ZKLMP16M04	*
16	3/8"	ZKLMP16M06	130,93
6	1/8"	ZKLMP06M02	25,90
6	1/4"	ZKLMP06M04	27,70
16	1/2"	ZKLMP16M08	*
16	3/4"	ZKLMP16M12	*
6	3/8"	ZKLMP06M06	28,85
6	1/2"	ZKLMP06M08	36,50
8	1/8"	ZKLMP08M02	30,66
8	1/4"	ZKLMP08M04	29,00
8	3/8"	ZKLMP08M06	29,17
8	1/2"	ZKLMP08M08	37,45
10	1/8"	ZKLMP10M02	32,97
10	1/4"	ZKLMP10M04	32,97
10	3/8"	ZKLMP10M06	32,97
10	1/2"	ZKLMP10M08	37,87
12	1/4"	ZKLMP12M04	39,56
12	3/8"	ZKLMP12M06	39,56
12	1/2"	ZKLMP12M08	42,50
12	3/4"	ZKLMP12M12	62,83
18	1/2"	ZKLMP18M08	74,32
18	3/4"	ZKLMP18M12	79,65
22	3/4"	ZKLMP22M12	*
22	1"	ZKLMP22M16	*
25	3/4"	ZKLMP25M12	133,35
25	1"	ZKLMP25M16	133,35

Male stud elbow BSPT

Racor en codo rosca cónica BSPT

W-Einschraubverschr. BSPT kon. - WE-R (KEG)

Raccord union coude mâle gaz conique



TUBO PIPE	ROSCA THREAD		Referencia Part n°	€
1/4"	1/8"	NEW	ZKLM0402	25,90
1/4"	1/4"		ZKLM0404	27,22
1/4"	3/8"		ZKLM0406	29,65
1/4"	1/2"		ZKLM0408	36,85
3/8"	1/4"	NEW	ZKLM0604	30,35
3/8"	3/8"		ZKLM0606	31,22
3/8"	1/2"		ZKLM0608	42,79
1/2"	1/4"	NEW	ZKLM0804	39,80
1/2"	3/8"	NEW	ZKLM0806	39,80
1/2"	1/2"		ZKLM0808	47,76
6	1/4"		ZKLM06M04	27,17
6	1/2"		ZKLM06M08	41,12
8	1/8"	NEW	ZKLM08M02	28,60
8	1/4"	NEW	ZKLM08M04	28,60
8	3/8"		ZKLM08M06	30,00
8	1/2"		ZKLM08M08	38,53
10	1/8"	NEW	ZKLM10M02	32,95
10	1/4"		ZKLM10M04	49,15
10	3/8"		ZKLM10M06	33,89
10	1/2"		ZKLM10M08	42,62
12	1/4"	NEW	ZKLM12M04	39,55
12	3/8"		ZKLM12M06	63,88
12	1/2"	NEW	ZKLM12M08	42,10
16	1/4"		ZKLM16M04	*
16	3/8"		ZKLM16M06	*
16	1/2"		ZKLM16M08	*
16	3/4"		ZKLM16M12	*
22	3/4"		ZKLM22M12	178,40
22	1"		ZKLM22M16	*

Twin Ferrule Fittings TrAle® LOK

Racor Doble Anillo TrAle® LOK
Verschraubungen für Doppelklemmring TrAle® LOK
Raccords double bague TrAle® LOK

Male stud branch TEE NPT

Racor en T rosca cónica NPT

T-Einschraubverschr. NPT (T-NPT)

Raccord TÉ mâle NPT au centre



TUBO PIPE	ROSCA THREAD	Referencia Part n°	€
1/8"	1/8"	ZKTMP0202	51,43
1/8"	1/4"	ZKTMP0204	55,26
1/4"	1/8"	ZKTMP0402	51,60
1/4"	1/4"	ZKTMP0404	55,26
3/8"	1/4"	ZKTMP0604	63,17
3/8"	3/8"	ZKTMP0606	*
1/2"	3/8"	ZKTMP0806	80,59
1/2"	1/2"	ZKTMP0808	91,07
6	1/8"	ZKTMP06M02	51,16
6	1/4"	ZKTMP06M04	56,29
8	1/8"	ZKTMP08M02	61,75
8	1/4"	ZKTMP08M04	61,75
10	1/4"	ZKTMP10M04	64,05
10	3/8"	ZKTMP10M06	88,56
12	1/4"	ZKTMP12M04	88,56
12	3/8"	ZKTMP12M06	88,56
12	1/2"	ZKTMP12M08	88,56

Male stud barrel TEE NPT

Racor en L rosca cónica NPT

L-Einschraubverschraubung NPT

Raccord Té mâle NPT latéral Inox



TUBO PIPE	ROSCA THREAD	Referencia Part n°	€
1/8"	1/8"	ZKTLMP0202	55,26
1/8"	1/4"	ZKTLMP0204	55,26
1/4"	1/8"	ZKTLMP0402	58,75
1/4"	1/4"	ZKTLMP0404	58,75
3/8"	1/4"	ZKTLMP0604	61,48
3/8"	3/8"	ZKTLMP0606	65,19
1/2"	3/8"	ZKTLMP0806	79,12
1/2"	1/2"	ZKTLMP0808	85,45
6	1/8"	ZKTLMP06M02	55,26
6	1/4"	ZKTLMP06M04	66,28
8	1/8"	ZKTLMP08M02	60,28
8	1/4"	ZKTLMP08M04	60,28
10	1/4"	ZKTLMP10M04	62,57
10	1/2"	ZKTLMP10M08	75,73
12	1/4"	ZKTLMP12M04	77,97
12	3/8"	ZKTLMP12M06	77,97
12	1/2"	ZKTLMP12M08	84,25

Straight bulkhead coupling

Racor recto pasatabique con tuercas

Gerade Schottverschraubung

Raccord droit union double passe cloison avec écrou



TUBO PIPE	Referencia Part n°	€
1/8"	ZKIB02	35,82
1/4"	ZKIB04	38,60
5/16"	ZKIB05	*
3/8"	ZKIB06	62,03
1/2"	ZKIB08	63,44
5/8"	ZKIB10	*
3/4"	ZKIB12	148,29
1"	ZKIB16	270,87
6	ZKIB06M	64,32
8	ZKIB08M	59,13
10	ZKIB10M	67,70
12	ZKIB12M	86,05
15	ZKIB15M	120,78
16	ZKIB16M	121,76
18	ZKIB18M	*
20	ZKIB20M	213,16
25	ZKIB25M	308,16

Straight bulkhead coupling- NPT

Racor recto - NPT pasatabique con tuercas

Gerade Schottkupplung - NPT

Raccord droit union double passe cloison avec écrou - NPT



TUBO PIPE	ROSCA THREAD	Referencia Part n°	€
1/8"	1/8"	ZKIBP0202	33,91
1/4"	1/4"	ZKIBP0404	35,27
3/8"	3/8"	ZKIBP0606	40,57
1/2"	1/2"	ZKIBP0808	55,80
3/4"	3/4"	ZKIBP1212	69,51
1"	1"	ZKIBP1616	235,87
6	1/8"	ZKIBP06M02	37,73
8	1/4"	ZKIBP08M04	37,73
10	3/8"	ZKIBP10M06	41,00
12	1/2"	ZKIBP12M08	57,33

Twin Ferrule Fittings TrΔle® LOK

Racor Doble Anillo TrΔle® LOK
Verschraubungen für Doppelklemmring TrΔle® LOK
Raccords double bague TrΔle® LOK

Female stud coupling NPT

Racor recto hembra rosca NPT

Einschraubkupplung NPT

Raccord union simple femelle NPT



TUBO PIPE	ROSCA THREAD	Referencia Part n°	€
1/8"	1/8"	ZKIHP0202	19,55
1/8"	1/4"	ZKIHP0204	21,46
1/8"	3/8"	ZKIHP0206	23,64
1/8"	1/2"	ZKIHP0208	27,35
1/4"	1/8"	ZKIHP0402	20,69
1/4"	1/4"	ZKIHP0404	22,66
1/4"	3/8"	ZKIHP0406	24,08
1/4"	1/2"	ZKIHP0408	29,05
3/8"	1/8"	ZKIHP0602	22,66
3/8"	1/4"	ZKIHP0604	24,19
3/8"	3/8"	ZKIHP0606	26,04
3/8"	1/2"	ZKIHP0608	31,12
3/8"	3/4"	ZKIHP0612	55,64
1/2"	1/8"	ZKIHP0802	30,19
1/2"	1/4"	ZKIHP0804	30,19
1/2"	3/8"	ZKIHP0806	31,23
1/2"	1/2"	ZKIHP0808	36,47
5/8"	1/2"	ZKIHP1008	*
3/4"	1/2"	ZKIHP1208	58,70
3/4"	3/4"	ZKIHP1212	102,38
1"	3/4"	ZKIHP1612	97,84
1"	1"	ZKIHP1616	162,22
6	1/8"	ZKIHP06M02	21,05
6	1/4"	ZKIHP06M04	22,50
6	3/8"	ZKIHP06M06	24,02
6	1/2"	ZKIHP06M08	29,70
8	1/8"	ZKIHP08M02	23,53
8	1/4"	ZKIHP08M04	23,53
8	3/8"	ZKIHP08M06	25,01
8	1/2"	ZKIHP08M08	30,30
10	1/4"	ZKIHP10M04	24,73
10	3/8"	ZKIHP10M06	26,32
10	1/2"	ZKIHP10M08	31,50
12	1/4"	ZKIHP12M04	30,74
12	3/8"	ZKIHP12M06	30,74
12	1/2"	ZKIHP12M08	35,87
16	1/2"	ZKIHP16M08	*
20	3/4"	ZKIHP20M12	87,19
22	3/4"	ZKIHP22M12	145,95
25	3/4"	ZKIHP25M12	99,48
25	1"	ZKIHP25M16	109,58
2"	2"	ZKIHP3232	*

Female stud coupling BSPT

Racor recto hembra rosca BSPT

Einschraubkupplung BSPT

Raccord union simple femelle BSPT



TUBO PIPE	ROSCA THREAD	Referencia Part n°	€
1/4"	1/4"	ZKIHO404	22,66
1/2"	1/4"	ZKIHO804	30,19
1/2"	1/2"	ZKIHO808	36,47
6	1/8"	ZKIHO6M02	20,53
6	1/4"	ZKIHO6M04	22,50
8	1/4"	ZKIHO8M04	23,53
8	1/2"	ZKIHO8M08	30,30
10	1/4"	ZKIHO10M04	24,73
20	3/4"	ZKIHO20M12	85,72

*On request / Consultar / Auf Anfrage / Sur demande

Válvulas de instrumentación

Válvulas de aguja, Manifold, Antirretornos y
Válvulas limitadoras de presión

BAJO CONSULTA

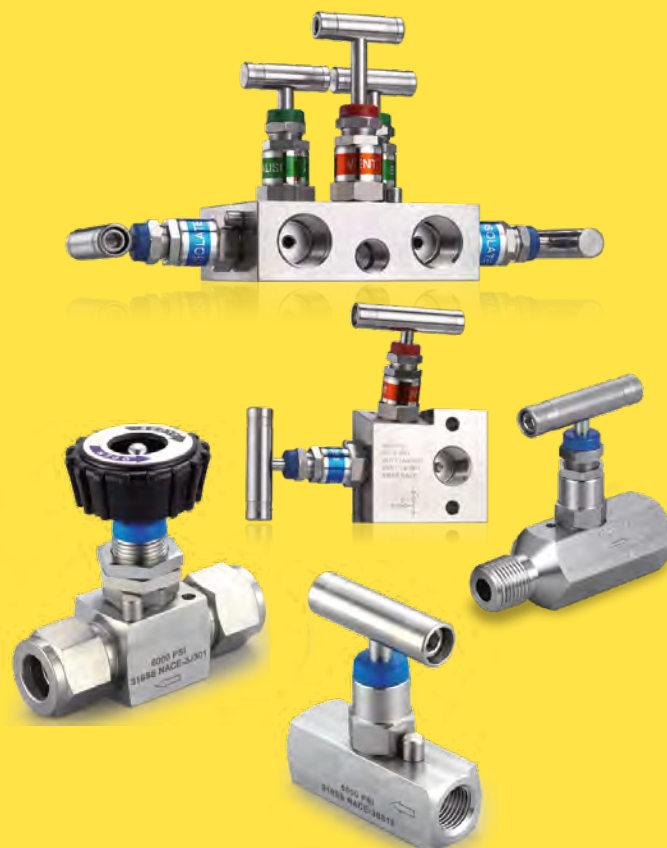

Instrument Valve

Needle Valve, Manifold,
Check and Proportional Relief Valve

ON REQUEST

Twin Ferrule Fittings TrAle® LOK

Racor Doble Anillo TrAle® LOK
Verschraubungen für Doppelklemmring TrAle® LOK
Raccords double bague TrAle® LOK

UNF plug closure

Tapón de cierre hembra UNF

UNF Verschlusskappe

Bouchon de fermeture Femelle UNF



TUBO PIPE	Referencia Part n°	€
1/8"	ZKOH02	13,10
1/4"	ZKOH04	14,61
5/16"	ZKOH05	14,52
3/8"	ZKOH06	16,57
1/2"	ZKOH08	20,62
5/8"	ZKOH10	30,52
3/4"	ZKOH12	41,44
1"	ZKOH16	60,33
6	ZKOH06M	16,60
8	ZKOH08M	14,89
10	ZKOH10M	16,27
12	ZKOH12M	19,38
14	ZKOH14M	26,21
15	ZKOH15M	28,99
16	ZKOH16M	29,32
18	ZKOH18M	32,81
20	ZKOH20M	40,40
22	ZKOH22M	41,93
25	ZKOH25M	54,71

UNF cap hexagon

Tapón hexagonal macho UNF

UNF-Sechskantstecker

Bouchon mâle hexagonale UNF



TUBO PIPE	Referencia Part n°	€
1/8"	ZKOM02	21,24
1/4"	ZKOM04	25,94
5/16"	ZKOM05	29,76
3/8"	ZKOM06	24,41
1/2"	ZKOM08	41,39
5/8"	ZKOM10	52,20
3/4"	ZKOM12	75,46
1"	ZKOM16	118,76
6	ZKOM06M	15,78
8	ZKOM08M	17,16
10	ZKOM10M	19,04
12	ZKOM12M	38,27
14	ZKOM14M	47,99
15	ZKOM15M	48,21
16	ZKOM16M	50,72
18	ZKOM18M	57,28
20	ZKOM20M	68,36
22	ZKOM22M	70,93
25	ZKOM25M	89,05

Tube end reducer

Racor de Reducción tubo

Reduzier-Verschraubung

Raccord de réduction



TUBO PIPE	Referencia Part n°	€
1/4" 1/8"	ZKIA0402	28,34
3/8" 1/4"	ZKIA0604	42,33
1/2" 3/8"	ZKIA0806	43,90
3/4" 1/2"	ZKIA1208	82,88
8 6	ZKIA08M06M	31,07
10 8	ZKIA10M08M	35,05
12 10	ZKIA12M10M	44,12
16 12	ZKIA16M12M	*

Male NPT adaptor

Adaptador macho NPT

NPT-Steckeradapter

Adapteur Mâle NPT



TUBO PIPE	ROSCA THREAD	Referencia Part n°	€
1/8"	1/8"	ZKIAMP0202	9,66
1/4"	1/4"	ZKIAMP0404	11,08
3/8"	3/8"	ZKIAMP0606	13,70
1/2"	1/2"	ZKIAMP0808	21,46
6	1/8"	ZKIAMP06M02	10,48
8	1/4"	ZKIAMP08M04	11,08
10	1/4"	ZKIAMP10M04	13,49
10	3/8"	ZKIAMP10M06	14,58
10	1/2"	ZKIAMP10M08	23,81
12	1/2"	ZKIAMP12M08	20,91

Female NPT adaptor

Adaptador hembra NPT

NPT-Adapterbuchse

Adapteur Femelle NPT



TUBO PIPE	ROSCA THREAD	Referencia Part n°	€
1/8"	1/8"	ZKIAHP0202	11,85
1/4"	1/4"	ZKIAHP0404	15,78
3/8"	3/8"	ZKIAHP0606	20,15
1/2"	1/2"	ZKIAHP0808	30,90
6	1/8"	ZKIAHP06M02	11,85
8	1/4"	ZKIAHP08M04	15,67
10	3/8"	ZKIAHP10M06	19,82
12	1/2"	ZKIAHP12M08	30,74

DESCUBRE nuestras TARIFAS GENERALES de PRECIOS

DICSA
GROWING UP TOGETHER



Conducciones hidráulicas y neumáticas
Hydraulic & Pneumatic Connectors



Componentes Hidráulicos y Neumáticos
Hydraulic and Pneumatic Components

REQUEST OUR GENERAL PRICE LIST

www.dicsaes.com

General conditions of sale

Condiciones de venta

GENERAL TERMS

These conditions, together with the eventual specific conditions accorded in the contract, apply to all deliveries and all services. The purchase conditions of the customer, if different from those herein established, will not be part of the contract on having accepted the order.

The contracts are concluded, unless otherwise agreed upon by the Parties in writing, by means of written confirmation of the supplier. The General Conditions and / or Specific Conditions of Purchase of the Buyer, cannot, in no case, cancel or replace these General Conditions of Sale.

The acceptance of our offers implies tacitly the acceptance of all the conditions detailed herein, except the special ones that have the agreement in writing, particularly in the same offer or detailed in our accuse of receipt of order, the only documents that oblige us before the Customer. DICSA has the right of property and the right of intellectual property of samples, budgets, technical documentation and information in material or immaterial form as well as in electronic form; the access of third parties to these documents must be forbidden.

OFFERS AND ORDERS

Except in case of having expressed the opposite, the prices include the merchandise placed in our store, including its loading, but without including the packing northtransporttotheplaceofreceipt, nortaxes, northegettingstarted- these will alwaysbeattheexpenseofthecustomer. Alltheoperationsoftransport, insurance, handling and delivery are on the account and risk of the Customer.

The offers include only the materials and products expressed in them, available in stock until end of stock, with the term of validity expressed in the same offers.

The studies or offers of material are based on the prices on the date the offer was made, and if, due to changes in the cost of the materials, modification of duties or to any other reason, the level of prices was checked, the prices that would be applied would be those that apply in the date of the delivery, unless the offer is accepted in the term of validity expressed in it.

The prices do not include, unless specific notification, the assembly and the getting started of the supplied materials, the fluids recommended by the technical services of the suppliers, the containers of the materials, as well as the study of the setting up of the different materials. DICSA may change the price, as a consequence of any law that concerns materials, wages, or the working hours, but also as a consequence of probable changes in the parity of the currency since it concerns the elements of import.

The orders will not be taken in consideration unless they are provided with the specific amount in our account, foreseen in our Offer, if this condition has been pre-established. The acceptance of the Offer will suppose equally the acceptance without reserve of these General Conditions of Sale.

STUDIES, TECHNICAL DOCUMENTATION

The information related to the offer, as technical documentation, designs, drawings, catalogues and / or any other technical documentation, is only informative and they have as object to give a general image of the materials described in them, they do not form a part of the contract unless written agreement. DICSA will not accept any type of responsibility for inaccuracy or omission of the above mentioned documentation.

The Customer will always have to do a previous study of compatibility and of assembly of the elements in his installation and will be the only responsible for the putting in conformity of the above mentioned installation with the current regulations. In offers, drawings, schemes and other technical information, we reserve ourselves the right of property and of design, not allowing that these should be facilitated to third parties without our previous written assent.

DICSA retains the property of the supplied merchandise until full payment of the agreed price. DICSA also retains the property of the Product's project, which in no circumstances shall be disclosed or sold to third parties.

THE ASSEMBLIES AT THE LOCATION (PLANT) OF THE CUSTOMER

The offers of the assemblies done for the customer, in his elected location of work, are considered as an estimate (approximate calculation), due to the particular and special characteristics that they can represent, not being able to give place, except final agreement between the parts, to final prices.

REPAIRMENT

The works of repair will not begin until written acceptance, on the part of the Customer, of the offer and of the conditions established in it. Supposing that the offer is not accepted by the Customer within one month, the expenses derived from the disassembly, storage, survey and freightage will be chargeable to the Customer. If the Customer requests the repair before accepting the offer, the assemblies will be carried out as soon as possible and, for his part, the Customer will have to accept the final cost of the repair.

In case of delivery of new products in exchange for the repair, if this one was out of guarantee, the Customer will have to accept the payment corresponding to it. The budgets of repair are always as estimation and should not be considered as final prices.

GENERALIDADES

Estas condiciones así como las eventuales condiciones especiales acordadas en el contrato rigen para todas las entregas y todas las prestaciones. Las condiciones de compra del cliente que sean distintas a las aquí establecidas no llegarán a formar parte del contrato al aceptar el pedido. Los contratos se celebran, salvo en el caso de que se haya acordado lo contrario, mediante confirmación escrita del proveedor. En ningún caso, las Condiciones Generales y/o Específicas de Compra del Comprador, anularán o sustituirán estas Condiciones Generales de Venta.

La aceptación de nuestras ofertas implica tácitamente la de todas las condiciones aquí detalladas, salvo las especiales acordadas por escrito, particularmente en la misma Oferta o detalladas en nuestro acuse de recepción de pedido, únicos documentos que nos obligan ante el Cliente.

DICSA se reserva el derecho de propiedad y el derecho de propiedad intelectual de muestras, presupuestos, planos e información en forma material o inmaterial así como en forma electrónica; el acceso de terceros a éstos ha de impedirse.

OFERTAS Y PEDIDOS

Los precios se entienden, caso de no expresar lo contrario para mercadería situada en nuestro almacén, incluyendo el cargado de ésta, pero sin incluir el embalaje ni el transporte al lugar de recepción, ni impuestos –que serán siempre a cargo del comprador–, así como tampoco la puesta en marcha en el emplazamiento. Todas las operaciones de transporte, seguro, manutención y entrega son a cuenta y riesgo del Comprador.

Las ofertas incluyen solamente los materiales y artículos en ellas especificados disponibles en stock salvo agotamiento y por el plazo de validez determinado en las mismas.

Los estudios u ofertas de material están basados en los precios vigentes en la fecha de su realización, y si, debido a alteraciones en el coste de los materiales, modificación de aranceles o a cualquier otra causa, el nivel de precios fuese revisado, los precios que se aplicarían serían aquellos que rijan en la fecha del suministro, a menos que la oferta sea aceptada dentro del plazo de validez que en la misma se fije.

Los precios no incluyen, excepto notificación expresa, el montaje y la puesta en marcha de los materiales suministrados, los fluidos recomendados por los servicios técnicos de los fabricantes, los contenedores tanto rígidos como elásticos de los materiales, así como el estudio de implantación de los distintos materiales.

DICSA podrá variar el precio, como consecuencia de cualquier ley que afecte a materiales, salarios o a las horas de trabajo y también a posible cambios en la paridad de la moneda, en elementos de importación.

Los pedidos no serán tomados en consideración a menos que vengan acompañados de la cantidad a cuenta prevista en nuestra Oferta, si así se ha establecido.

La aceptación de la Oferta supondrá igualmente la aceptación sin reservas de estas Condiciones Generales de Venta.

ESTUDIOS, PLANOS Y DISEÑOS

La información relacionada con la oferta, tal como planos, diseños, dibujos catálogos y/u otra documentación técnica, es solamente informativa y tienen como objeto dar una imagen general de los materiales en ellos descritos, no formando parte del contrato a menos que haya habido algún acuerdo por escrito. DICSA no aceptará ningún tipo de responsabilidad por la inexactitud u omisión de dicha documentación.

El Cliente deberá hacer siempre un estudio previo de compatibilidad y de montaje de los elementos en su instalación y será el único responsable de la puesta en conformidad de dicha instalación con las distintas reglamentaciones vigentes.

En presupuestos, planos, esquemas y otras informaciones técnicas, mantendremos reservado el derecho de propiedad y de realización, no permitiendo que estos sean facilitados a terceros sin nuestro previo consentimiento escrito.

DICSA se reserva el derecho de propiedad de la mercancía suministrada hasta el pago completo del precio establecido. DICSA se reserva el derecho de propiedad de los planos de la mercancía, que no serán facilitados ni vendidos a terceros en ningún caso.

TRABAJOS IN SITU

Los presupuestos de los trabajos realizados en el lugar de la obra del cliente son considerados orientativos, debido a las características particulares y especiales que pueden representar, no pudiendo dar lugar, excepto acuerdo definitivo entre las partes, en precios definitivos.

REPARACIÓN

Los trabajos de reparación no se empezarán hasta la aceptación escrita, por parte del Cliente, del presupuesto y de las condiciones que se establezcan.

En el supuesto de que el presupuesto no sea aceptado por el Cliente en el plazo de un mes, los gastos derivados del desmontaje, almacenaje, peritaje y portes correrán a cargo del Cliente. Si el Cliente solicita la reparación antes de aceptar el presupuesto, los trabajos se llevarán a cabo lo antes posible y, por su parte, el Cliente deberá aceptar el coste final de la reparación.

General conditions of sale

Condiciones de venta

DELIVERY TERMS

DICSA saves itself the right to reject an order depending on the availability of the products. In this supposition, DICSA will communicate it to the Customer as promptly as possible.

The delivery time has to be approved by the contractual parts. The delivery time will be calculated from the date of receipt of the confirmation of the order, when DICSA will be able to proceed without any interruption. DICSA will not be responsible for the delays in the supply of all or in part of the goods in case of major force, such as natural catastrophes, legal limitations, strikes, etc., or any other reason beyond our control. In case of any of the reasons previously mentioned, the period of delivery will be extensible to the same period of time that lasts the reason that has motivated the delay. Nevertheless, if the period exceeds six months, DICSA may cancel the part that couldn't be sent, by previously notifying the Customer in writing.

We do our best to respect the delivery times that are indicated in our offers or in our order confirmations, though it is materially impossible to answer completely for the above mentioned fulfillment, since we depend on other suppliers and on unexpected circumstances totally foreign to our possible control. Won't be accepted any sanctions for the delay in the foreseen delivery.

RIGHT OF PROPERTY

DICSA maintains the property of the materials (products) until the Customer makes the payment in full of the merchandise.

The Customer is responsible for taking the necessary actions to preserve in good condition the merchandise until it has been paid, must insure DICSA of the payment of the same one in case of having being sold to third persons by the Customer.

WARRANTY

We won't attend any claim done after the 12 months following the delivery of the merchandise. Returned material will not be allowed without previous authorization or when the time between the purchase and the request for return exceeds 15 days.

In any case, all returned merchandise will have to be accompanied by a copy of our authorization and, providing that it is not for reasons attributable to DICSA, will carry a minimal surcharge of 20 % on the cost of the returned material, all the expenses will be charged to the customer. Concerning the faults that appear in the supplied products, DICSA will only accept as unique responsibility or obligation, the paying of the product or defective products providing that the products (merchandise) have been treated adequately and that the arisen faults are due to faults of material or manufacture.

The warranty includes the replacement or repair of the defective elements in our workshops. The warranty is understood always in relation with the presumably defective material deposited in our warehouse, but the costs of transport and the risk being at the expense of the Customer. The advices given before and post closing of the contract, are made with the best intention and according to our know-how, nevertheless DICSA does not assume any category of responsibilities in this regard, nor will answer of the eventual direct or indirect damages that could take place indistinctly, no matter who, where and why they may take place.

DICSA will not be responsible for any consequence or indirect damages occurred to the Customer, and / or third Parties including but not limited to loss of opportunities, business and incomes.

DICSA guarantees exclusively its own materials, excluding any responsibility for the effects or damages that these could provoke in facilities, equipments or conductions. In no case will take responsibility for accidents related to individuals or materials or for losses in fabrication.

The warranty excludes the breakdowns produced by badly use or deficient installation, breakdowns provoked by overloading of the equipments for experimental purposes, either for adjustment or testing. DICSA's total responsibility for the caused damages, independently of the type of action or theory of the responsibility, will not exceed the amount of the work done, installation or materials that have been object of the order to DICSA.

Any amount that exceeds the above mentioned quantity, and any amount that DICSA will have to support either for judicial, arbitral or similar decision, will be transmitted to the Customer until obtaining indemnity.

Will be excluded from this warranty:

- The use of facilities or services, which are different of those included in the manuals of instruction or in DICSA's specifications.
- The inadequate use of facilities or negligence of the Customer, his Assistants or Agents.
- The parts supplied by the Customer.

En caso de entregarse productos nuevos a cambio de la reparación, si esta estuviera fuera de garantía el Cliente deberá aceptar el cargo correspondiente a la misma.

Los presupuestos de reparación siempre son orientativos y en ningún caso deben tomarse como precios finales.

PLAZOS DE ENTREGA

DICSA se reserva la facultad de rechazar un pedido en función de la disponibilidad de los productos. En este supuesto, lo comunicara al comprador con la mayor brevedad posible.

El plazo de entrega será acordado por las partes contractuales. Los plazos de entrega se calcularán desde la fecha de recepción de la confirmación del pedido, pudiendo DICSA proceder sin interrupción alguna. DICSA no será responsable de las demoras en el suministro de toda o parte de la mercancía en el caso de fuerza mayor, tal como catástrofes naturales, limitaciones legales, huelgas, etc., o cualquier otra causa fuera de nuestro control. En el caso de darse alguna de las razones anteriormente citadas, el periodo de entrega se hará extensible al mismo período de tiempo que dure la causa que haya motivado el retraso. Sin embargo, si el período excediera de seis meses, DICSA podrá cancelar la parte no enviada notificando previamente por escrito al comprador.

Procuramos con el mayor interés, cumplir los plazos de entrega que se indican en nuestras ofertas o en nuestras confirmaciones de pedido, si bien es materialmente imposible responder plenamente de dicho cumplimiento, por depender de otros proveedores y de inesperadas circunstancias totalmente ajenas a nuestro posible control.

De ahí que no se aceptarán sanciones por demora en la entrega prevista.

DERECHO DE PROPIEDAD

DICSA mantiene la propiedad de la mercancía hasta que el comprador realice el pago por completo de la misma.

Será responsabilidad del comprador tomar las medidas necesarias para conservar en buen estado la mercancía hasta que haya sido pagada, debiendo asegurarse a DICSA el cobro de la misma en caso de haber sido vendida a terceras personas por el comprador.

GARANTÍA

No se responderá de ninguna reclamación que no sea efectuada dentro de los 12 meses siguientes a la entrega de la mercancía, ni se aceptarán devoluciones sin autorización previa o pasados 15 días desde la entrega de la mercancía. En cualquier caso, toda devolución deberá ir acompañada de copia de nuestra autorización y, siempre que no sea por causas imputables a DICSA, conllevará un recargo mínimo del 20 % sobre el coste del material devuelto, corriendo todos los gastos a cargo del cliente.

En relación con los defectos que aparezcan en los productos suministrados, DICSA aceptará como única responsabilidad u obligación, abonar la pieza o piezas defectuosas siempre que la mercancía haya sido tratada adecuadamente y que los defectos surgidos sean debidos a defectos de material o fabricación.

La garantía comprende la reposición o reparación de los elementos defectuosos a realizar en nuestros talleres.

La garantía se entiende siempre con el material presumiblemente defectuoso depositado en nuestras instalaciones, con los gastos de transporte y riesgo a cargo del comprador.

Los consejos y asesoramiento dados antes y post cierre del contrato, se realizan con la mejor intención y según nuestros máximos conocimientos, no obstante DICSA no asume ninguna clase de responsabilidades a este respecto, ni responderá de los eventuales daños directos o indirectos que indistintamente, por quién, dónde y por qué puedan producirse.

DICSA no será responsable de ninguna consecuencia o ningún daño indirecto producido al Comprador o a terceros, incluyendo los daños de pérdida de oportunidades, negocio o ingresos.

DICSA garantiza exclusivamente sus materiales excluyendo cualquier responsabilidad por los efectos o perjuicios que estos puedan provocar en instalaciones, maquinarias o circuitos. En ningún caso se responsabilizará de los accidentes personales o materiales y pérdidas de producción.

Se excluye de la garantía las averías producidas por mal uso o deficiente instalación, averías provocadas por sometimiento de los equipos a esfuerzos anormales con fines experimentales, de ajuste o prueba. La total responsabilidad de DICSA por los daños causados, independientemente del tipo de acción o teoría de la responsabilidad, no excederá del importe de la obra, instalación o materiales que haya sido objeto de pedido a DICSA. Cualquier importe que supere dicha cantidad y que DICSA se vea obligada a soportar ya sea por decisión judicial, arbitral o similar, será repetida a la compradora hasta lograr indemnidad.

Se encuentran excluidos de esta garantía:

- *El uso de instalaciones o servicios, que se aparten de los manuales de instrucción o especificaciones de DICSA.*
- *El uso inadecuado de instalaciones o negligencia del Comprador, sus Ayudantes o Agentes.*
- *Las partes suministradas por el Comprador.*

General conditions of sale

Condiciones de venta

FREIGHTAGES

By merchandise we always mean the one deposited in DICSA's warehouse, even in operations conditioned by the delivery at destination and the merchandise will always travel at the account and risk of the Customer, being at his charge, including the additional insurances that could be established and the special permissions it may need. According to what it is established in the article 18 of the Royal decree 782/1998 concerning wrapping and packaging mentioned in the 1st additional Disposition (Regulation) of the Law 11/1997, the person responsible for the delivery of the residues of the packaging and worn packages, for the correct environmental management, will be the final user.

EMERGENCY DELIVERIES

No matter the type of the transportation used: by plane, courier, as baggage (luggage), special agencies, messengers etc; independently of the amount of the above mentioned service, the Customer will pay all the extra expenses, those of transportations, of shipping, and of communications that the service has caused; this value may not, under no circumstance, be lower than 60 euros.

SPECIAL ORDERS

Any order (request) of special material, will carry the anticipated payment of 50 % of the amount of the order (request), as an indispensable condition for its acceptance. The above mentioned amount will always be in favor of DICSA as compensation in case of cancellation on the part of the Customer, without prejudice of the claims at which they may have right by Law.

MINIMAL SALE

The minimal invoice will be of 50 €, no matter the amount of the order.

PAYMENTS

The payments have to be done, except express written agreement between the parts, in maximum 60 days from the date of the invoice and previous receipt of the positive reports of credit. If the Customer doesn't make the payment in time, for a part of the merchandise supplied, DICSA is authorized to suspend the posterior deliveries until the Customer executes the due payments. Any bank charges associated with the payment of the merchandise, as well as the expenses of return of it in case of non-payment, will be at the expense of the Customer. In case of delay in the payment and without prejudice of other rights attributed to the buyer for the legislation in effect, the Customer will pay to DICSA an interest of monthly delay of 2 % starting from the date when the invoice comes to its term.

UNPAID OR POST-PONED INVOICES

Will be at the expense of the Customer:

- The return expenses.
- Monthly interests of 1 %, from the day when the payment has come to its term and wasn't made, until the date of full payment.
- Possible amount (value) of the stamp of the new documents.
- The credit insurance.

COINCIDENTAL PAYMENTS IN VACATIONS

If the client could not attend to the payments that were coinciding with vacation periods, these will move to the same day of the previous month. In case there are fixed days of payment, the term of the invoice will move to the immediately previous working day of payment.

THE SOFTWARE USE

If the delivery includes the putting at the disposal of the Customer software, the Customer has the exclusive right to use it, including the attached documentation. The software is sent for the use in the object of delivery to which it is destined. It is forbidden the use of this software into any other system. The modification, translation or adjustment of the code of object to code of origin as well as the reproduction of software is only admitted into the legally established limits. The Customer promises not to withdraw the indications of the manufacturer, especially the indications of the Copyright, without DICSA's previous assent. All the other rights on the software and the documentation including the copies, they belong to DICSA or to the supplier of the software. The concession of sublicenses is not admitted.

GOVERNING LAW AND JURISDICTION

These General Conditions and any agreement between DICSA and the Customer shall be exclusively governed by Spanish laws. The exclusive jurisdiction on any dispute between the DICSA and the Customer shall be the courts of DICSA's domicile. Nevertheless, DICSA has also the right to bring legal action against the Customer before the courts of the place of business and/or residence of the Customer.

PORTES

La mercancía se entiende siempre depositada en el domicilio de DICSA, incluso en operaciones condicionadas a la entrega en destino y la mercancía siempre viajará por cuenta y riesgo del comprador, siendo a su cargo inclusive los seguros adicionales que pudieran establecerse y los permisos especiales a que hubiera lugar.

Según se establece en el artículo 18 del Real Decreto 782/1998 para los envases y embalajes acogidos a la Disposición adicional 1.ª de la Ley 11/1997, el responsable de la entrega de los residuos de los embalajes y envases usados, para su correcta gestión ambiental, será el usuario final.

ENVÍOS DE EMERGENCIA

Sea cual fuere el medio de transporte utilizado, avión, courier, régimen de equipajes, agencias especiales, mensajeros etc. Independientemente del importe de dicho servicio, el comprador correrá con todos los gastos extra, los de acarreo, de desplazamientos, y de comunicaciones que el servicio haya ocasionado, sin que en ningún caso este valor pueda ser inferior a 60 euros.

PEDIDOS ESPECIALES

Todo pedido de material especial, conllevará el pago anticipado del 50 % del importe del pedido, como condición indispensable para su aceptación. Dicho importe quedará siempre a favor de DICSA como indemnización en cualquier caso de anulación por parte del comprador, sin perjuicio de las reclamaciones que por Ley se puedan tener derecho.

VENTA MÍNIMA

La facturación mínima será de 50 € sea cual sea el importe del pedido.

PAGOS

Los pagos se realizarán como máximo y salvo acuerdo expreso entre las partes, a 60 días desde la fecha de la factura y previa recepción de los informes positivos de crédito. Si el comprador no efectuare el pago de cualquiera de los suministros a su vencimiento, DICSA está autorizado a suspender los envíos posteriores hasta que se realice dicho pago. Cualquier cargo bancario asociado con el pago de la mercancía, así como los gastos de devolución de efectos en caso de impago, serán por cuenta del comprador.

En caso de demora en el pago y sin perjuicio de otros derechos atribuidos al comprador por la legislación en vigor, el comprador abonará a DICSA un interés de demora del 2 % mensual desde la fecha de vencimiento de la factura.

COBRO DE LETRAS O RECIBOS DEVUELTOS O APLAZADOS

Serán a cargo del librado:

- Gastos de devolución.
- Intereses del 1 % mensual desde el día del vencimiento fallido hasta la fecha de cobro definitivo.
- Posible valor del timbre de nuevos documentos.
- Prima de seguro de crédito.

PAGOS COINCIDENTES EN VACACIONES

Si el cliente no pudiese atender los pagos que coincidiesen con periodos vacacionales, éstos se trasladarán al mismo día del mes anterior. En caso de existir días fijos de pago, el vencimiento se trasladará al día hábil de pago inmediatamente anterior.

USO DE SOFTWARE

En la medida en que el volumen de entrega incluye la puesta a disposición de software, el cliente tiene el derecho no exclusivo a usarla incluyendo la documentación adjunta. Se le cede el software para el uso en el objeto de entrega al cual va destinado. No se admite el uso de este software en otro sistema. La modificación, traducción o adaptación de código de objeto a código de origen así como la reproducción de software solamente se admite en la medida legalmente establecida. El cliente se compromete a no retirar las indicaciones del fabricante, especialmente indicaciones del Copyright sin el consentimiento previo de DICSA. Todos los demás derechos sobre el software y la documentación incluyendo las copias, corresponden a DICSA o al proveedor del software. No se admite la concesión de sublicencias.

DERECHO APLICABLE Y JURISDICCIÓN

Las relaciones jurídicas entre DICSA y el comprador están sujetas al derecho Español. El tribunal competente será el del domicilio de DICSA. Sin embargo, DICSA podrá optar por interponer las acciones legales correspondientes en el domicilio del comprador.

► Información general

General information

DICSA ESPAÑA

Sede | Head Office

Tel. +34 976 46 10 46
info@dicsaes.com

DICSA ITALIA SRL

Tel. +39 059 820 179
italia@dicsaes.com

DICSA AMERICA

Tel. 786 358 6662
america@dicsaes.com

DICSA DEUTSCHLAND

Tel. +34 976 464 106
export@dicsaes.com

DICSA LATAM

Tel. +34 976 464 106
america@dicsaes.com

DICSA ASIA PACIFIC

Tel. +34 976 464 106
asia-pacific@dicsaes.com

DICSA TÜRKIYE

Tel. +90 533 080 67 08
turkiye@dicsaes.com

Atención al cliente | Customer service

Departamento comercial | Commercial department

Gestión de pedidos | Orders management

Nacional | National

Tel. 976 464 108
comercial@dicsaes.com

Internacional | International

Tel. +34 976 464 106
export@dicsaes.com

Nacional | National

Conducciones | Connectors
Tel. 976 464 100
976 464 101

Hidráulica | Components
Tel. 976 464 102
pedidos@dicsaes.com

Internacional | International

Tel. +34 976 464 100
+34 976 464 101
orders@dicsaes.com

Otros servicios | Other services

Dpto. Calidad | Quality Dpt.

Tel. +34 976 479 545
calidad@dicsaes.com

Dpto. Informática | IT Dpt.

Tel. +34 976 479 555
informatica@dicsaes.com

Dpto. Producción | Production Dpt.

Tel. +34 976 479 543
produccion@dicsaes.com

Dpto. Finanzas | Accounting Dpt.

Tel. +34 976 479 542
finanzas@dicsaes.com

Dpto. Compras | Purchasing Dpt.

Tel. +34 976 464 107
compras@dicsaes.com

Oficina de almacén | Warehouse Dpt.

Tel. +34 976 464 101
almacen@dicsaes.com

DICSA

www.dicsaes.com

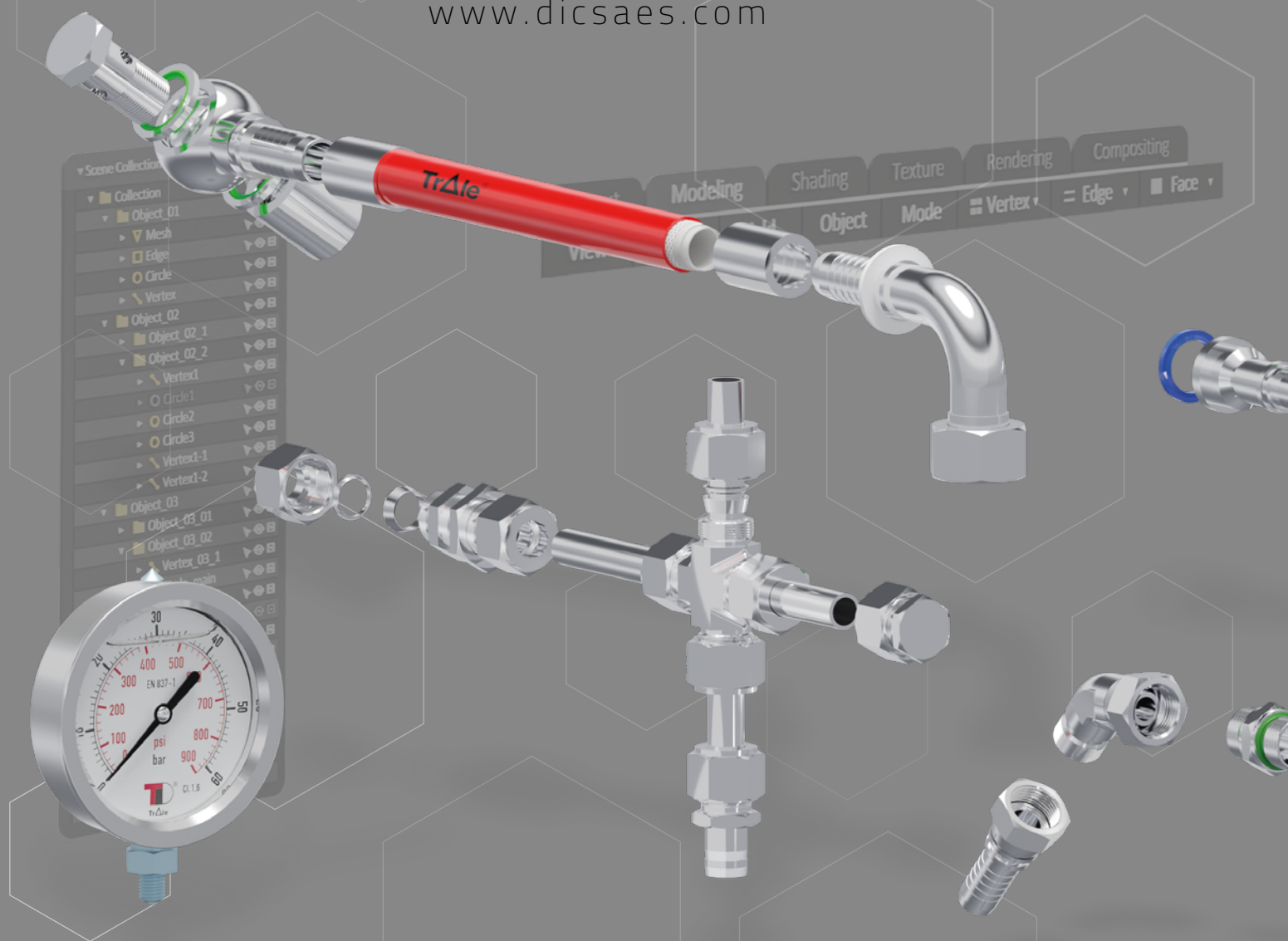

DICSA ITALIA SRL
Via Emilia Ovest 1179/c
41123 Modena (Italia)
Tel. +39 059 820 179
italia@dicsaes.com

DICSA AMERICA LLC
875 NE 191 STR.
STE 302 Aventura. FL 33180
Tel. 786-358-6662
Whatsapp: +34 617548815
america@dicsaes.com

DICSA DEUTSCHLAND
Logististikzentrum GmSH
Thomas Dachser Str. 1 ·
76316 Malsch (Alemania)
Tel. +34 976 464 106
export@dicsaes.com

DICSA LATAM
Tel. +34 976 464 106
america@dicsaes.com

DICSA ASIA-PACIFIC
Tel. +34 976 464 106
asia-pacific@dicsaes.com

DICSA TÜRKIYE
Tel. 90 533 080 67 08
turkiye@dicsaes.com

2024